

Multifamily Domestic Hot Water



Measure ID: 25-MF-DHW-19, 25-MF-DHW-23, 25-MF-DHW-24
Multifamily Domestic Hot Water (DHW)

February 2025



This report was prepared by the California Statewide Codes and Standards Enhancement (CASE) Program that is funded, in part, by California utility customers under the auspices of the California Public Utilities Commission. Copyright 2024 Pacific Gas and Electric Company, Southern California Edison, San Diego Gas & Electric Company, Los Angeles Department of Water and Power, and Sacramento Municipal Utility District. All rights reserved, except that this document may be used, copied, and distributed without modification.

Neither Pacific Gas and Electric Company, Southern California Edison, San Diego Gas & Electric Company, Los Angeles Department of Water and Power, Sacramento Municipal Utility District or any of its employees makes any warranty, express or implied; or assumes any legal liability or responsibility for the accuracy, completeness or usefulness of any data, information, method, product, policy or process disclosed in this document; or represents that its use will not infringe any privately-owned rights including, but not limited to, patents, trademarks or copyrights.



Document Information

Category:	Codes and Standards
Keywords:	Statewide Codes and Standards Enhancement (CASE) Initiative, Statewide Utility Codes and Standards Team, Codes and Standards Enhancements, 2025 Title 24, Part 6, efficiency, Central Heat Pump Water Heater, Unitary Heat Pump Water Heater, Electric-Ready, Domestic Hot Water Distribution System, California Plumbing Code Appendix M, Pipe Insulation, Balancing Valve, Master Mixing Valve
Authors:	Jingjuan “Dove” Feng, Amin Delagah, Jose Garcia, Catherine Chappell, Yiyi Chu, Daniel Hacking, Ben Seeley, Debrudra Mitra (TRC), James Haile (Frontier Energy)
Acknowledgements	Evan Green, Jonathan Heller (Ecotope), Ben Larson (Larson Energy Research), Yanda Zhang (ZYD Energy), Western Allied Mechanical, Villara.
Prime Contractor	TRC
Project Management:	California Utilities Statewide Codes and Standards Team: Pacific Gas and Electric Company, Southern California Edison, San Diego Gas & Electric Company, Los Angeles Department of Water and Power, and Sacramento Municipal Utility District

Table of Contents

1. Introduction	1
2. Measure Description	2
2.1 Summary of Adopted Requirements	2
2.2 Summary of Proposed Requirements That Were Not Adopted	7
3. Statewide Energy Impacts of Adopted Requirements	7
4. Compliance and Enforcement	8
5. Interactions with Existing Regulations	9
5.1 Submeasures: CPC Appendix M Pipe Sizing	9
5.2 Submeasure: Pipe Insulation Enhancement	9
6. Evolution of Code Requirements	9
6.1 Submeasure: CPC Appendix M Pipe Sizing	9
6.2 Submeasure: Pipe Insulation Enhancement	10
6.3 Submeasure: Thermostatic Balancing Valves	10
6.4 Submeasure: Master Mixing Valves	10
6.5 Submeasure: Central HPWH Clean-up	10
6.6 Submeasure: Individual HPWH Ventilation	10
6.7 Submeasure: Individual DHW Electric Ready	11
6.8 Submeasure: Central DHW Electric Ready	12
6.9 Submeasure: Eliminate Demand Recirculation Control for Circulation Systems Serving Multiple Dwelling Units	12
7. Adopted Code Language	12
7.1 California Energy Code, Title 24, Part 6	12
SECTION 160.4 – MANDATORY REQUIREMENTS FOR WATER HEATING SYSTEMS	15
SECTION 160.9 – MANDATORY REQUIREMENTS FOR ELECTRIC READY BUILDINGS	18
SECTION 100.1(b) – DEFINITIONS AND RULES OF CONSTRUCTION	27
7.2 Reference Appendices RA3.6 Field Verification of Water Heating Systems	28
8. Bibliography	36
Attachment 1: Public Comments Submitted by the Statewide CASE Team	37
Attachment 2: Final CASE Report	38

List of Tables

Table 1: Scope of Adopted Code Change	6
Table 2: Estimated Statewide First Year ^a Energy and Water Savings	7

1. Introduction

The Codes and Standards Enhancement (CASE) Initiative presents recommendations to support the California Energy Commission’s (CEC) efforts to update the California Energy Code (Title 24, Part 6) to include new requirements or to upgrade existing requirements for various technologies. Three California Investor-Owned Utilities (IOUs)—Pacific Gas and Electric Company, San Diego Gas and Electric, and Southern California Edison—and two Publicly-Owned Utilities—Los Angeles Department of Water and Power, and Sacramento Municipal Utility District (herein referred to as the Statewide CASE Team when including the CASE Author)—sponsored this effort. The program goal is to prepare and submit proposals that will result in cost-effective enhancements to improve energy efficiency and energy performance in California buildings to the CEC, the state agency with authority to adopt revisions to Title 24, Part 6. The CEC evaluates proposals submitted by the Statewide CASE Team and other stakeholders and may revise or reject proposals.

In August 2023, the Statewide CASE Team submitted the CASE Report in Attachment 2, recommending code changes. Eight of the nine measures pertain to multifamily domestic hot water systems and ventilation requirements for unitary heat pump water heaters in occupancy types. The CASE Report describes the nine adopted submeasures:

1. California Plumbing Code (CPC) Appendix M Pipe Sizing
2. Pipe Insulation Enhancement
3. Master Mixing Valve
4. Thermostatic Balancing Valve
5. Central Heat Pump Water Heater (HPWH) Clean-up
6. Individual HPWH Ventilation
7. Individual DHW Electric Ready Clean-up
8. Central DHW Electric Ready
9. Eliminate Demand Recirculation Control for Circulation Systems Serving Multiple Dwelling Units

These measures support the state’s greenhouse gas (GHG) reduction goals and increase building energy efficiency.

This document explains the revisions to the proposed code changes from the Statewide CASE Team’s submission of the Final CASE Report to the CEC’s adoption of the 2025 Title 24, Part 6 Standards on September 11, 2024. The document begins with a concise description of the adopted code language, followed by the estimated energy savings of

the adopted requirements, with the remainder of the document outlining the evolution of the code changes and the final adopted language.

2. Measure Description

2.1 Summary of Adopted Requirements

This report describes the nine adopted submeasures. These measures seek to support the state's GHG reduction goals and increase building energy efficiency through several strategies:

- **Reduce Pipe Loss:** Require enhanced insulation, promoting more efficient pipe sizing methodology, prescriptively requiring installation of a master mixing valve and encouraging the use of thermostatic balancing valves to reduce pipe loss in multifamily DHW distribution systems and hot water heating plants.
- **Promote Central HPWH Technology:** Revise prescriptive requirements for central HPWH technology in multifamily buildings to ensure system efficiency and reliability. To increase compliance flexibility, introduce an alternative pathway leveraging the Northwest Energy Efficiency Alliance's (NEEA) Advanced Water Heating Specification (AWHS).
- **Mandate Proper Ventilation:** Ensure operational efficiency for all building types by mandating proper ventilation for unitary HPWHs.
- **Require Proper Ventilation:** Require new construction multifamily buildings with individual and central gas water heaters in new construction, mandating the buildings to be electric-ready, preventing cost-prohibitive future electrification retrofits. In addition, the adopted requirements include the elimination of demand recirculation control in multifamily buildings.

2.1.1 California Plumbing Code (CPC) Appendix M Pipe Sizing

The adopted code requirement includes using pipe sizing methodology based on CPC Appendix M instead of the standard practice CPC Appendix A. Specifically, this change adds a prescriptive requirement in Section 170.2(d) for sizing water pipes according to CPC Appendix M for central DHW systems in multifamily buildings. This measure applies only to newly constructed multifamily buildings and requires minor updates to the compliance software. No field verification or acceptance tests are added.

2.1.2 Pipe Insulation Enhancement

The adopted code requirement for pipe insulation enhancement includes updating the mandatory requirements and adding a prescriptive requirement for verifying the quality of pipe insulation in the field. The first component clarifies the mandatory pipe insulation requirements under Title 24, Part 6, Section 160.4. The second introduces a prescriptive

requirement in 170.2(d) for field verification to confirm the installation of code-required pipe insulation and the overall quality of insulation installation. This measure applies exclusively to newly constructed buildings and requires updates to the compliance software.

2.1.3 Thermostatic Balancing Valves

The adopted code change adds a compliance option for smaller recirculation systems serving multi-riser central DHW systems in multifamily buildings. It also applies to additions and alterations projects when the scope includes the replacement of the existing water heater or adding new plumbing fixtures requiring hot water. This code change requires updates to the compliance software.

To receive the compliance credit:

1. Each DHW supply riser must have an accessible thermostatic balancing valve (TBV).
2. The DHW circulating pump must be variable speed with differential pressure control.
3. Hot water return piping may not exceed 160 feet in length for systems with one recirculation return pipe loop.
4. No return pipe may exceed 160 feet in developed length for systems with multiple recirculation return pipe loops.
5. The TBV shall be set to a maximum temperature of 120 °F, and a startup procedure is required to confirm intended operation.

This measure requires updates to the compliance software.

2.1.4 Require Master Mixing Valves

The adopted code requirement includes the installation of a thermostatic master mixing valve (MMV) conforming to the [ASSE 1017-2009](#) standard. Specifically, this change adds language to Section 170.2(d) - Prescriptive Approach for Water Heating Systems. The MMV must be installed on the central heating plant hot water supply outlet header leading to the recirculation loop and commissioned according to the manufacturer's instructions and applicable Reference Appendix. Plumbing plans must include MMV installation details and specifications, and if water mixing parameters exceed the MMV's capabilities, the designer must provide valve commissioning instructions to prevent temperature creep. This measure requires updates to the compliance software.

2.1.5 Central HPWH Clean-up

This adopted code change revises the existing prescriptive requirements for central heat pump water heater (HPWH) plant design and control approaches. It also adds an alternative pathway leveraging Northwest NEEA's Advanced Water Heating Specification (AWHS) V8.1 for commercial HPWH systems. The changes only impact new construction multifamily buildings, including:

- Revising the existing prescriptive requirements to use single-pass HPWH as the primary equipment in DHW plant design.
- Removing the primary storage tank plumbing configuration requirement to allow design flexibility for HPWH.
- Clarifying recirculation loop tank heater requirements.
- Adding an alternative prescriptive pathway that ensures system efficiency and reliability using NEEA AWHS V8.1 Tier 2.

This measure does not modify the standard central HPWH model in the compliance software.

2.1.6 Individual HPWH Ventilation

This adopted code requirement introduces mandatory requirements for all building types to provide adequate ventilation for consumer-sized integrated HPWHs by:

- Adjusting existing definitions in Section 100.1(b) to differentiate HPWH types.
- Adding "Air-Source Heat Pump Water Heater" to Section 110.3(c).

Ventilation paths include:

- Large unvented room/closet with minimum volume requirements.
- Small vented room/closet with specific volume and net free area requirements.
- Direct ducting to the HPWH inlet or outlet with insulation and sealing requirements.
- Manufacturer-approved ventilation methods are included in the permit application.

The requirement prohibits using outdoor air for ventilation without backup heat if the compressor cutout temperature exceeds the Winter Median of Extremes for the nearest location listed in JA2.2, Table 2-3.

2.1.7 Individual DHW Electric Ready Clean-up

This adopted code requirement enhances and clarifies the existing mandatory electric-ready requirements in Title 24, Part 6 Section 160.4 for new construction multifamily buildings with gas or propane individual water heaters. The language has been moved to Section 160.9, and updates include:

- Ensuring building-level electrical system components can accommodate future HPWH.
- Updating branch conductor size requirements.
- Reserving space and planning for future HPWH ventilation needs.

Based on stakeholder feedback, this measure also improves code language in Section 150.0(n) for single-family homes. The improvement updates the branch conductor size requirement to a 120/240-volt 3 conductor branch circuit rated to 30 amps.

2.1.8 Central DHW Electric Ready

This adopted code introduces mandatory electric-ready requirements for new construction multifamily buildings that use gas or propane central water heating equipment. Compliance can be achieved by one of two pathways:

1. Meeting a specific HPWH design with sufficient design documentation.
2. Meeting prescribed sizing factors.

Requirements include:

- Reserving adequate physical space for the future HPWH.
- Planning for future HPWH ventilation needs.
- Installing condensate drainage piping to serve future HPWH.
- Documenting the building's electrical system can accommodate future HPWH equipment.

2.1.9 Eliminate Demand Recirculation Control for Circulation Systems Serving Multiple Dwelling Units

The adopted code change removes the prescriptive requirement for demand recirculation control to align with changes made to the compliance modeling software. In 2020, the CEC removed demand controls from the compliance software due to stakeholder concerns about technical feasibility in multifamily buildings without updating the code language.

In late 2022, the Statewide CASE Team met with CEC staff and the California Building Energy Code Compliance (CBECC) software team to understand why demand control was removed from the compliance software and discovered that technical concerns had been brought to CEC's attention. The Statewide CASE Team also received input from several experts in domestic hot water systems who voiced similar concerns.

The key issues are summarized below:

- Multifamily buildings operate 24 hours a day due to variances in occupant schedules, leaving little opportunity for energy saving by reducing recirculation system operation.
- Allowing the hot water distribution system to cool below approximately 117°F to 120°F poses a health risk due to potential legionella growth.
- Demand control systems are frequently deactivated, leading to significantly lower actual savings than expected.

In 2023, the Statewide Team worked with the CEC to remove the prescriptive requirement from the code language to ensure consistency with software.

Table 1: Scope of Adopted Code Change

Measure Name	Type of Requirement	Modified Section(s) of Title 24, Part 6	Modified Title 24, Part 6 Appendices	Will Compliance Software Be Modified?
CPC Appendix M Pipe Sizing	Prescriptive	170.2(d)2BiiC	No	Yes
Pipe Insulation Enhancement	Mandatory and Prescriptive	160.4(e)4 170.2(d)2BiiE	Residential Appendix RA3.6.3	Yes
Thermostatic Balancing Valves	Performance	170.1(b)2D	RA4.4.3	Yes
Require Master Mixing Valves	Prescriptive	170.2(d)2BiiD	Residential Appendix RA4.4.19	Yes
Central HPWH Clean-up	Prescriptive	170.2(d)2	No	No
Individual HPWH Ventilation	Mandatory	110.3(c)7	No	Yes
Individual DHW Electric Ready Clean-up	Mandatory	160.9(e) 160.9(e)4.B.i	No	No
Central DHW Electric Ready	Mandatory	160.9(f)	JA15(new)	No

Eliminate Demand Recirculation Control for Circulation Systems Serving Multiple Dwelling Units	Prescriptive	170.2(d)	No	No
-------------------------------------------------------------------------------------------------------	--------------	----------	----	----

2.2 Summary of Proposed Requirements That Were Not Adopted

All proposed measures were adopted.

Table 1 identifies sections of the Standards and Reference Appendices modified due to advocacy activities for all nine code changes. The table also specifies whether the compliance software will be updated.

Table 1: Scope of Adopted Code Change

Measure Name	Type of Requirement	Modified Section(s) of Title 24, Part 6	Modified Title 24, Part 6 Appendices	Will Compliance Software Be Modified?
CPC Appendix M Pipe Sizing	Prescriptive	170.2(d)2BiiC	No	Yes
Pipe Insulation Enhancement	Mandatory and Prescriptive	160.4(e)4 170.2(d)2BiiE	Residential Appendix RA3.6.3	Yes
Thermostatic Balancing Valves	Performance	170.1(b)2D	RA4.4.3	Yes
Require Master Mixing Valves	Prescriptive	170.2(d)2BiiD	Residential Appendix RA4.4.19	Yes
Central HPWH Clean-up	Prescriptive	170.2(d)2	No	No

Individual HPWH Ventilation	Mandatory	110.3(c)7	No	Yes
Individual DHW Electric Ready Clean-up	Mandatory	160.9(e) 160.9(e)4.B.i	No	No
Central DHW Electric Ready	Mandatory	160.9(f)	JA15(new)	No
Eliminate Demand Recirculation Control for Circulation Systems Serving Multiple Dwelling Units	Prescriptive	170.2(d)	No	No

2.3 Summary of Proposed Requirements That Were Not Adopted

All proposed measures were adopted.

3. Statewide Energy Impacts of Adopted Requirements

Table 2 shows the estimated energy savings of the adopted requirements over the first twelve months that the new requirements are in effect. The first-year savings have not changed since submitting the Final CASE Report.

Table 2: Estimated Statewide First Year^a Energy and Water Savings

Measure	First Year Electricity Savings (GWh/yr)	First Year Peak Electrical Demand Reduction (MW)	First Year Water Savings (million gallons/yr)	First Year Natural Gas Savings (million therms/yr)
CPC Appendix M Pipe Sizing	0.68	0.08	9,296,024	0.21
New Construction & Additions	0.68	0.08	9,296,024	0.21

Alterations	N/A	N/A	N/A	N/A
Pipe Insulation Enhancement	1.1	0.12	N/A	0.42
New Construction & Additions	1.1	0.12	N/A	0.42
Alterations	N/A	N/A	N/A	N/A
Thermostatic Balancing Valves	0.07	0.01	N/A	0.01
New Construction & Additions	0.01	N/A	N/A	N/A
Alterations	0.06	0.01	N/A	0.01
Master Mixing Valves	0.65	0.38	N/A	0.31
New Construction & Additions	0.65	0.38	N/A	0.31
Alterations	N/A	N/A	N/A	N/A
Central HPWH Clean-up	N/A	N/A	N/A	N/A
New Construction & Additions	N/A	N/A	N/A	N/A
Alterations	N/A	N/A	N/A	N/A
Individual HPWH Ventilation	4.94	0.36	N/A	N/A
New Construction & Additions	4.09	0.30	N/A	N/A
Alterations	0.85	0.06	N/A	N/A
Individual DHW Electric Ready	N/A	N/A	N/A	N/A
New Construction & Additions	N/A	N/A	N/A	N/A
Alterations	N/A	N/A	N/A	N/A
Central DHW Electric Ready	N/A	N/A	N/A	N/A
New Construction & Additions	N/A	N/A	N/A	N/A
Alterations	N/A	N/A	N/A	N/A
Eliminate Demand Recirculation Control for Circulation Systems Serving Multiple Dwelling Units	N/A	N/A	N/A	N/A
New Construction & Additions	N/A	N/A	N/A	N/A
Alterations	N/A	N/A	N/A	N/A

a. First-year savings from all buildings completed statewide in 2025.

4. Compliance and Enforcement

The CEC adopted all of the Statewide CASE Team's proposed requirements. Changes to compliance and enforcement are detailed in Attachment 1: Public Comments Submitted by the Statewide CASE Team

Attachment 1 presents comments that the Statewide CASE Team submitted to the CEC’s docket that are relevant to this measure.

257749	7/15/2024	CA Statewide Utility Codes and Standards Enhancement Team Comments - CASE Team Additional Comments to 45-Day Express Terms
--------	-----------	-----------------------------------------------------------------------------------------------------------------------------------

257467	6/27/2024	CA Statewide Utility Codes and Standards Enhancement Team Comments - 2025 Title 24 CASE Team comments on 15-Day Express Terms
--------	-----------	--------------------------------------------------------------------------------------------------------------------------------------

256540	5/24/2024	CA Statewide Utility Codes and Standards Enhancement Team Comments on 45-Day Express Terms - May 24 2024
--------	-----------	-----------------------------------------------------------------------------------------------------------------

Attachment 2: Final CASE Report.

5. Interactions with Existing Regulations

5.1 Submeasures: CPC Appendix M Pipe Sizing

No changes required for the following submeasures:

- CPC Appendix M Pipe Sizing
- Thermostatic Balancing Valves
- Mixing Valves
- Central HPWH Clean-up
- Individual HPWH Ventilation
- Individual DHW Electric Ready
- Central DHW Electric Ready
- Eliminate Demand Recirculation Control for Circulation Systems Serving Multiple Dwelling Units

See Attachment 2: Final CASE Report.

5.2 Submeasure: Pipe Insulation Enhancement

Changes were made based on the adopted code language, requiring prescriptive pipe insulation quality verification in Section 170.2. All updates to mandatory pipe insulation requirements remain in the original location in Section 160.4, with only edits for clarity. See Section 4.1.4: Regulatory Context found in Attachment 2: Final CASE Report.

6. Evolution of Code Requirements

The Statewide CASE Team submitted the Final CASE Report to the CEC in August 2023. The Final CASE Report addresses input received during utility-sponsored stakeholder meetings held on February 17, 2023, May 1, 2023, and during the CEC's pre-rulemaking workshop on August 23, 2023. This section describes how the code change proposal evolved from the Statewide CASE Team's submission of the Final CASE Report to the CEC's adoption of the standards.

6.1 Submeasure: CPC Appendix M Pipe Sizing

This measure was fully adopted without changes to the CASE Report's language requirements. However, in the 45-Day Language, the CEC simplified the code language, significantly altering the intent from applying to both heating plant and distribution hot water piping to only distribution piping, which reduced the modeled energy savings. In response, the Statewide CASE Team raised this issue with CEC, leading to adjustments in the code language to a version that aligns with the CASE Report. This modification ensures all hot water piping use the Appendix M pipe sizing methodology.

6.2 Submeasure: Pipe Insulation Enhancement

Following discussions with the Compliance Improvement Team, the Statewide CASE Team recommended changing verification from mandatory to prescriptive. This change was suggested because as a new verification measure, there is a high likelihood that the requirement could be overlooked and that the walls and ceilings could be closed before verification. Raters may feel pressure to falsely verify compliance to avoid reopening them. Changing to prescriptive provides greater flexibility for late adjustments using the performance approach to offset energy penalties from incomplete pipe insulation verification. The mandatory pipe insulation measures were fully adopted with no significant changes to the language, except for grammatical improvements for conciseness and readability.

6.3 Submeasure: Thermostatic Balancing Valves

This measure was fully adopted with no changes to the language requirements.

6.4 Submeasure: Master Mixing Valves

This measure was fully adopted and with no significant changes to the language requirements, except for grammatical improvements for conciseness and readability.

6.5 Submeasure: Central HPWH Clean-up

In the Final CASE Report, the proposed code language referenced NEEA AWHs V8.0 in the prescriptive requirement, as AWHs V8.1 had not been published. After NEEA released V8.1 on July 15, 2024, the Statewide CASE Team reviewed the differences between V8.1 and V8.0 and confirmed that referencing V8.1 would not affect the measure's energy or cost. The Statewide CASE Team facilitated a meeting with CEC and NEEA, who supported including the V8.1 reference in the final code language.

Other than the AWHs version update, the measure was fully adopted with minor editorial changes in the language requirements from the CASE Report.

6.6 Submeasure: Individual HPWH Ventilation

This measure was fully adopted with minor editorial changes in the language requirements from the CASE report. Based on stakeholder feedback, three clarification changes were made:

1. Gary Klein and Nick Brown submitted a comment to suggest adding “Air-Source” to the heading of the new coded section to clarify that the measure applies only to air-source HPWHs (Gary Klein and Associates, Inc., 2024). The Statewide CASE Team responded to this suggestion in a submission to the docket on May 24, 2024, recommending that the CEC accept the addition, which they did in the 15-Day Language.
2. Gary Klein and Nick Brown submitted a comment requesting clearer language regarding the positions and proportional net free area of the two permanent openings in 110.3(c)7B3ii (Gary Klein and Associates, Inc., 2024). The Statewide CASE Team's complete response to Gary Klein and Nick Brown's comments was submitted as a comment to the docket on May 24, 2024 (CA Statewide Utility Codes and Standards Enhancement Team, 2024). In that response, the Statewide CASE Team recommended that the CEC accept this recommendation from Gary Klein and Nick Brown and proposed language changes. The CEC included these clarification changes in the 15-Day Language.
3. Maya Gantley of 2050 Partners contacted the Statewide CASE Team to express concerns regarding the potential impacts of some HPWH ventilation options on

balanced ventilation systems, particularly in multifamily buildings. In response, the Statewide CASE Team summarized these concerns and presented an analysis and recommendations to the docket on May 3, 2024, as a comment on the 45-Day Language (CA Utility CASE Team and Compliance Improvement Team, 2024). The CEC followed the recommendations by adding a non-regulatory note to the end of Section 110.3(c)7 to inform designers and installers of this potential issue.

6.7 Submeasure: Individual DHW Electric Ready

Gary Klein & Nick Brown submitted a comment proposing revisions to the code language, allowing for planning ducted ventilation from the electric-ready space to other indoor spaces along with other changes. The Statewide CASE Team met with them to discuss their experience with ducting HPWH to vent indoors, noting that this is a common strategy for in-unit HPWH. The Statewide CASE Team indicated that similar feedback had been requested during earlier stakeholder meetings but had not been received. Subsequently, the Statewide CASE Team collaborated with the CEC to update the code language to include this feedback. The CEC accepted this suggestion with minor revisions.

The reference to Section 160.9(f) was removed from the requirements for systems using gas or propane water heaters to serve individual dwelling units. The list of components that these systems must include remains unchanged. This change occurred because the previous reference to Section 160.9(f) no longer applies due to structural changes in the code.

The Statewide CASE Team updated the code language to specify that fully louvered doors must now consist of a single layer of fixed flat slats. This update provides clearer guidance for constructing fully louvered doors and ensures consistency with the HPWH ventilation measure.

6.8 Submeasure: Central DHW Electric Ready

The Statewide CASE Team clarified that the code language applies to gas or propane water heating systems with an input capacity of less than 200,000 Btu per hour. This change improved the clarity of the language, ensuring the regulation specifically targets gas or propane water heating systems rather than only gas systems.

Additionally, the reference to the requirement for electric readiness specified in Title 24, Part 6, Section 160.9(f) was updated. The Statewide CASE Team corrected the previous reference to "Section 160.9(e)" to reflect the appropriate section. This update

ensures that the correct requirements are followed for electric readiness in systems installed with gas or propane water heaters.

6.9 Submeasure: Eliminate Demand Recirculation Control for Circulation Systems Serving Multiple Dwelling Units

This measure was fully adopted with no changes to the language requirements.

7. Adopted Code Language

The adopted code language for the standards and Reference Appendices are presented in the following sections. Additions to the 2022 Title 24, Part 6 code language are underlined and deletions are ~~struck~~.

7.1 California Energy Code, Title 24, Part 6

SECTION 110.3 – MANDATORY REQUIREMENTS FOR SERVICE WATER-HEATING SYSTEMS AND EQUIPMENT

6. **Air-Source Heat Pump Water Heaters (HPWHs).** HPWH shall meet the following requirements:
 - A. **Backup Heat.** Backup heat is required for ~~air-source~~ systems when inlet air is unconditioned, unless the compressor ~~cutout~~-cut-off temperature is below the Heating Winter Median of Extremes for the closest location listed in Table 2-3 from Reference Joint Appendix JA2. Backup heat may be internal or external to the HPWH.
 - B. **Ventilation.** Consumer integrated HPWHs shall meet one of the ventilation requirements below. Minimum volume and opening size requirements shall be the sum of all HPWHs installed within the same space. Compressor capacity shall be determined using AHRI 540 Table 4 reference conditions for refrigeration with the “High” rating test point:
 1. Installed using a method provided by the manufacturer to meet or exceed the level of performance provided by the ventilation requirements of Section 110.3(c)7B2 through Section 110.3(c)B4.
 2. For HPWH installation without ducts, the installation space shall have a volume ~~equal to~~ not less than the greater of 100 cubic feet per kBtu per hour of compressor capacity, or the minimum volume provided by the manufacturer for this method; or

3. For HPWH installation without ducts, the installation space shall be vented to a communicating space via permanent openings, according to the following requirements:
 - i. Communicating space shall meet the minimum volume of Section 110.3(c)7B~~12~~ above, minus the volume of the HPWH installation space; and
 - ii. Permanent openings shall consist of a single layer of fixed flat slat louvers or grilles, with a total minimum Net Free Area (NFA) the larger of 125 square inches plus 25 square inches per kBtu per hour of compressor capacity, or the minimum provided by the manufacturer for this method. The permanent openings shall be fully louvered doors or two openings of equal area, one in the upper half of the enclosure and one in the bottom half of the enclosure. The top of the upper opening must be 12 inches or less from the enclosure top and the bottom of the lower vent must be 12 inches or less from the

enclosure bottom one located within 12 inches from the enclosure top and one located within 12 inches from the enclosure bottom; or

4. For HPWH installations with ducts, the following requirements shall be met:

- 7.1.1
 - i. The space joined to the installation space via ducts shall meet the minimum volume of Section 110.3(c)7B~~12~~ above, minus the volume of the HPWH installation space; and
 - ii. All duct connections and building penetrations shall be sealed; and
 - iii. Exhaust air ducts and all ducts which cross pressure boundaries shall be insulated to minimum of R-6; and
 - iv. ~~If~~ Where only the HPWH inlet or outlet is ducted, installation space shall include permanent openings which consist of a single layer of fixed flat slat louvers or grilles in the bottom half of the room, and/or a door undercut. With a ducted inlet, the minimum NFA shall be equal to the cross-sectional area of the duct. With a ducted exhaust, the minimum NFA shall be the larger of 20 square inches or the minimum NFA provided by the manufacturer for this method; and
 - v. ~~If~~ Where the inlet and outlet ducts both terminate within the same pressure boundary, airflow from the termination points shall be diverted away from each other; ~~or~~.

5. Installed using a method certified by the manufacturer to meet the ventilation requirements of 110.3(c)7B.

Note: Ducting only the inlet or the exhaust across the pressure boundary could interfere with balanced ventilation systems. This should be considered when specifying HPWH location and ventilation method.

Note: Authority: Sections 25213, 25218, 25218.5, 25402 and 25402.1, Public Resources Code.
Reference: Sections 25007, 25008, 25218.5, 25310, 25402, 25402.1, 25402.4, 25402.8, and 25943, Public Resources Code.

SECTION 150.0 – MANDATORY FEATURES AND DEVICES

(n) Water Heating System

Systems using gas or propane water heaters to serve individual dwelling units shall designate a space at least 2.5 feet by 2.5 feet wide and 7 feet tall suitable for the future installation of a heat pump water heater (HPWH) by meeting either A or B below. All electrical components shall be installed in accordance with the *California Electrical Code*:

- A. If the designated space is within 3 feet from the water heater, then this space shall include the following:
 - i. A dedicated 125 volt, 20 amp electrical receptacle that is connected to the electric panel with a 120/240 volt 3 conductor, ~~10 AWG copper~~ branch circuit rated at 30 amps minimum, within 3 feet from the water heater and accessible to the water heater with no obstructions; and
 - ii. Both ends of the unused conductor shall be labeled with the word “spare” and be electrically isolated; and
 - iii. A reserved single pole circuit breaker space in the electrical panel adjacent to the circuit breaker for the branch circuit in A above and labeled with the words “Future 240V Use”; and
 - iv. A condensate drain that is no more than 2 inches higher than the base of the installed water heater and allows natural draining without pump assistance.

SECTION 160.4 – MANDATORY REQUIREMENTS FOR WATER HEATING SYSTEMS

(a) ~~Systems using gas or propane water heaters to serve individual dwelling units shall include the following components:~~

1. ~~A dedicated 125 volt, 20 amp electrical receptacle that is connected to the electric panel with a 120/240 volt 3 conductor, 10 AWG copper branch circuit, within 3 feet from the water heater and accessible to the water heater with no obstructions. In addition, all of the following:~~
 - A. ~~Both ends of the unused conductor shall be labeled with the word “spare” and be electrically isolated; and~~
 - B. ~~A reserved single pole circuit breaker space in the electrical panel adjacent to the circuit breaker for the branch circuit in A above and labeled with the words “Future 240V Use”; and~~
2. ~~A Category III or IV vent, or a Type B vent with straight pipe between the outside termination and the space where the water heater is installed; and~~
3. ~~A condensate drain that is no more than 2 inches higher than the base of the installed water heater, and allows natural draining without pump assistance; and~~
4. ~~A gas supply line with a capacity of at least 200,000 Btu/hr.~~

~~(ab)~~ Water-heating recirculation loops serving multiple dwelling units shall meet the requirements of Section 110.3(c)4.

(ef) Pipe Insulation for piping and tanks

All piping for multifamily domestic hot water systems shall be insulated and meet the applicable requirements 1 through 4-3 below:

1. 1- General Requirements.

- A. The first 8 feet of inlet cold water piping from the storage tanks, including piping between a storage tank and a heat trap shall be insulated.
- B. Insulation on the piping and domestic hot water system appurtenances shall be continuous.
- C. Pipe supports, hangers, and pipe clamps shall be attached on the outside of rigid pipe insulation to prevent thermal bridges.
- D. All pipe insulation seams shall be sealed.
- E. Insulation for pipe elbows shall be mitered, preformed, or site fabricated with PVC covers.
- F. Insulation for tees shall be notched, preformed, or site fabricated with PVC covers.
- G. Extended stem isolation valves shall be installed.

- H. All plumbing appurtenances on hot water piping from a heating source to heating plant, at the heating plant, and distribution supply and return piping shall be insulated to meet the following requirements:
- i. ~~1-~~ Where the outer diameter of the appurtenance is less than the outer diameter of the insulated pipe that it is attached to, the appurtenance shall be insulated flush with the insulation surrounding the pipe.
 - ii. ~~2-~~ Where the outer diameter of the appurtenance is greater than the outer diameter of the insulated pipe that it is attached to, the appurtenance shall be insulated with a minimum thickness of 1 inch. ~~iii.~~ ~~3-~~ The insulation shall be removable and re-installable to ensure maintenance or replacement services can be completed.
 - iv. ~~4-~~ Valves shall be fully functional without impediment from the insulation.

2. **Insulation Thickness.** All Piping for multifamily domestic hot water systems shall be insulated to meet the insulation thickness requirements specified in ~~of~~ Table 160.4-A.

A. For insulation conductivity in the range shown in Table 160.4-A for the applicable fluid temperature range, the insulation shall have the applicable minimum thickness or R-value shown in Table 160.4-A.

B. if the insulation conductivity falls outside the range provided in Table 160.4-A applicable fluid temperature range, the insulation shall meet a minimum R-value as indicated in Table 160.4-A. Or, it can have a thickness determined using Equation 160.4-A"

$$t = \frac{K}{PR} \left(\frac{1}{R} + t \right) - 1 \quad \text{(Equation 160.4-A)}$$

WHERE:

T = Minimum insulation thickness for material with conductivity K, inches.

PR = Pipe actual outside radius, inches.

t = Insulation thickness from TABLE 160.4-A, inches.

K = Conductivity of alternate material at the mean rating temperature indicated in TABLE 160.4-A for the applicable fluid temperature range, in Btu-inch per hour per square foot per °F.

k = The lower value of the conductivity range listed in TABLE 160.4-A for the applicable fluid temperature range, Btu-inch per hour per square foot per °F.

C. Insulation conductivity shall be determined in accordance with ASTM C335 at the mean temperature listed in Table 160.4-A, and shall be rounded to the nearest 1/100 Btu-inch per hour per square foot per °F.

~~**Exception 1 to Section 160.4(f)1:** Factory installed piping within space conditioning equipment certified under Section 110.1 or 110.2.~~

Exception 2-1 to Section 160.4(e)1: Piping that penetrates framing members shall not be required to have pipe insulation for the distance of the framing penetration. Piping that penetrates metal framing shall use grommets, plugs, wrapping or other insulating material to ensure that no contact is made with the metal framing. Insulation shall abut securely against all framing members.

Exception 3-2 to Section 160.4(e)1: Piping installed in interior or exterior walls shall not be required to have pipe insulation if all of the requirements are met for compliance with quality insulation installation (QII) as specified in Reference Residential Appendix RA3.5.

Exception 4-3 to Section 160.4(e)1: Piping surrounded with a minimum of 1 inch of wall insulation, 2 inches of crawl space insulation or 4 inches of attic insulation shall not be required to have pipe insulation.

TABLE 160.4-A PIPE INSULATION THICKNESS – Multifamily Domestic Hot Water Systems

Fluid Operating Temperature Range (°F)	Insulation Conductivity (Btu-in/h-ft ² °F)	Insulation Conductivity Mean Rating Temp. (°F)	Nominal Pipe Diameter (in inches) < 1	Nominal Pipe Diameter (in inches) 1 to <1.5	Nominal Pipe Diameter (in inches) 1.5 to < 4	Nominal Pipe Diameter (in inches) 4 to < 8	Nominal Pipe Diameter (in inches) 8 and larger
105-140 ¹	0.22-0.28	100	1.0 (R 7.7)	1.5 (R 12.5)	2.0 (R 16)	2.0 (R 12.5)	2.0 (R 11)

Footnote to TABLE 160.4-A:

- Multifamily and hotel/motel domestic hot water systems with water temperature above 140°F shall use the row in table 120.3-A for the applicable water temperature.

32. Insulation Protection. Pipe Insulation shall be protected from damage due to sunlight, moisture, equipment maintenance and wind. Protection shall, at minimum, include the following:

- A. Pipe and appurtenance insulation exposed to weather shall be protected by a cover suitable for outdoor service. The cover shall be water retardant and provide shielding from solar radiation that can cause degradation of the material. Appurtenance insulation covers shall be removable and able to be re-installed. Adhesive tape shall not be used to provide this protection.
- B. Pipe insulation covering chilled water piping and refrigerant suction piping located outside the conditioned space shall include, or be protected by, a Class I or Class II vapor retarder. All penetrations and joints shall be sealed.
- C. Pipe insulation buried below grade must be installed in a waterproof and noncrushable casing or sleeve.

~~4 Insulation Quality Verification. Insulation for hot water pipes and plumbing appurtenances shall be field verified as specified in Residential Reference Appendix RA3.6.3.~~

SECTION 160.9 – MANDATORY REQUIREMENTS FOR ELECTRIC READY BUILDINGS

(a) General Requirements. Multifamily buildings shall comply with the applicable requirements of subsection 160.9. The building electrical system shall be sized to meet the future electric requirements of the electric ready equipment specified in sections 160.9(ab) through (ef). The building main service conduit, the electrical system to the point specified in each subsection, and any on-site distribution transformers shall have sufficient capacity to supply full rated amperage at each electric ready appliance in accordance with the California Electrical Code.

(ba) Heat Pump Space Heater Ready. Systems using gas or propane furnaces to serve individual dwelling units shall include the following:

- 1. A dedicated 240 volt branch circuit wiring shall be installed within 3 feet from the furnace and accessible to the furnace with no obstructions. The branch circuit conductors shall be rated at 30 amps minimum. The blank cover shall be identified as “240V ready.” All electrical components shall be installed in accordance with the California Electrical Code.
- 2. The main electrical service panel shall have a reserved space to allow for the installation of a double pole circuit breaker for a future heat pump space heater installation. The reserved space shall be permanently marked as “For Future 240V use.”

(c) Electric Cooktop Ready. Systems using gas or propane cooktops to serve individual dwelling units shall include the following:

1. A dedicated 240 volt branch circuit wiring shall be installed within 3 feet from the cooktop and accessible to the cooktop with no obstructions. The branch circuit conductors shall be rated at 50 amps minimum. The blank cover shall be identified as "240V ready." All electrical components shall be installed in accordance with the California Electrical Code.
2. The main electrical service panel shall have a reserved space to allow for the installation of a double pole circuit breaker for a future electric cooktop installation. The reserved space shall be permanently marked as "For Future 240V use."

(d) Electric Clothes Dryer Ready. Clothes dryer locations with gas or propane plumbing shall include the following:

1. Systems serving individual dwelling units shall include:
 - A. A dedicated 240 volt branch circuit wiring shall be installed within 3 feet from the clothes dryer location and accessible to the clothes dryer location with no obstructions. The branch circuit conductors shall be rated at 30 amps minimum. The blank cover shall be identified as "240V ready." All electrical components shall be installed in accordance with the California Electrical Code.
 - B. The main electrical service panel shall have a reserved space to allow for the installation of a double pole circuit breaker for a future electric clothes dryer installation. The reserved space shall be permanently marked as "For Future 240V use."
2. Systems in common use areas shall include:
 - A. Conductors or raceway shall be installed with termination points at the main electrical panel, via subpanels panels if applicable, to a location no more than 3 feet from each gas outlet or a designated location of future electric replacement equipment. Both ends of the conductors or raceway shall be labelled "Future 240V Use." ~~The conductors or raceway and any intervening subpanels, panelboards, switchboards and busbars shall be sized to meet the future electric power requirements, at the service voltage to the point at which the conductors serving the building connect to the utility distribution system, as specified below. The capacity requirements may be adjusted for demand factors in accordance with the California Electric Code.~~ Gas flow rates shall be determined in accordance with the California Plumbing Code. Capacity shall be one of the following:
 - i. 24 amps at 208/240 volts per clothes dryer; ii. 2.6 kVA for each 10,000 Btu per hour of rated gas input or gas pipe capacity; or

- iii. The electrical power required to provide equivalent functionality of the gas-powered equipment as calculated and documented by the responsible person associated with the project.

(e) Individual Heat Pump Water Heater Ready. Systems using gas or propane water heaters to serve individual dwelling units shall include the following components for each gas or propane water heater ~~and shall meet the requirements of Section 160.9(f):~~

1. A dedicated 125 volt, 20 amp electrical receptacle that is connected to the electric panel with a 120/240 volt 3 conductor branch circuit rated to 30 amps minimum, within 3 feet from the water heater and accessible to the water heater with no obstructions. In addition, all the following:
 - A. Both ends of the unused conductor shall be labeled with the word "spare" and be electrically isolated; and
 - B. A reserved single pole circuit breaker space in the electrical panel adjacent to the circuit breaker for the branch circuit in A above and labeled with the words "Future 240V Use"; and
2. A condensate drain that is no more than 2 inches higher than the base of the installed water heater, and allows natural draining without pump assistance, and
3. The construction drawings shall designate a space at least 39 inches by 39 inches and 96 inches tall for the future location of heat pump water heater.
4. A ventilation method meeting one of the following:
 - A. The designated space for the future heat pump water heater shall have a minimum volume of 700 cubic feet; or
 - B. If the future HPWH space is designed to vent indoors, the designated space for the future heat pump water heater shall vent to a communicating space in the same pressure boundary via permanent openings with a minimum total NFA of 250 square inches, so that the total combined volume connected via permanent openings shall be 700 cubic feet or larger; and vent to the interior via The permanent openings shall be:
 - i. Fully louvered doors with fixed louvers consisting of a single layer of fixed flat slats and a minimum total NFA of 250 square inches; or
 - ii. Two permanent fixed openings of equal area with a minimum total NFA of 250 square inches located within 12 inches from the enclosure top and bottom; or
 - iii. Two 8-inch ducts to a communicating space.
 - C. If the future HPWH space is designed to vent to the building exterior, the designated space for the future heat pump water heater shall vent to the exterior via:

- i. Fully louvered doors with fixed louvers consisting of a single layer of fixed flat slats and a minimum total NFA of 250 square inches; or
- ii. Two permanent fixed openings of equal area with a minimum total NFA of 250 square inches located within 12 inches from the enclosure top and bottom; or
- iii. Two 8 inches capped ducts. All ducts that cross the pressure boundary shall be insulated to a minimum insulation level of R-6 and the ducts, connections, and building penetrations shall be sealed.

~~C. The designated space for the future heat pump water heater shall include two 8 inches capped ducts, venting to the building exterior:~~

- ~~i. All ducts, connections, and building penetrations shall be sealed.~~
- ~~ii. Exhaust air ducts and all ducts which cross pressure boundaries shall be insulated to a minimum insulation level of R-6.~~

~~Airflow from termination points shall be diverted away from each other.~~

(f) Central Heat Pump Water Heater Ready. Central water heating systems using gas or propane to serve multiple dwelling units shall ~~include~~ meet the following requirements:

1. The system input capacity of the gas or propane water heating system shall be determined as the sum of the input gas or propane capacity of all water heating devices associated with each gas or propane water heating system.

2. Space reserved shall include:

A. Heat Pump. The minimum space reserved shall include space for service clearances and air flow clearances and shall meet one of the following:

- i. The space reserved shall be the space required for a heat pump water heater system that meets the total building hot water demand as calculated and documented by the responsible person associated with the project; or
- ii. The space reserved shall meet the requirements specified in Joint Appendix JA15.2.1.

B. Tanks. The minimum space reserved shall include space for service clearances and shall meet one of the following:

- i. The space reserved shall be the space required for a heat pump water heater system that meets the total building hot water demand as calculated and documented by the responsible person associated with the project; or
- ii. The space reserved shall meet the requirements specified in Joint Appendix JA15.2.2.

3. Ventilation shall be provided by meeting one of the following:
 - A. Physical space reserved for the heat pump shall be located outside; or
 - B. A pathway shall be reserved for future routing of supply and exhaust air via ductwork from the reserved heat pump location to a suitable outdoor location. Penetrations through the building envelope for louvers and ducts shall be planned and identified for future use. The reserved pathway and penetrations through the building envelope shall be sized to meet one of the following:
 - i. The reserved pathway and penetrations shall be sized to serve a heat pump water heater system that meets the total building hot water demand as calculated and documented by the responsible person associated with the project.
 - ii. The reserved pathway and penetrations shall be sized to meet the requirements specified in Joint Appendix JA15.2.3.
4. Condensate drainage piping. An approved receptacle that is sized per the California Plumbing Code for condensate drainage shall be installed within 3 feet of the reserved heat pump location, or piping shall be installed from within 3 feet of the reserved heat pump location to an approved discharge location that is sized in accordance with the California Plumbing Code, and meet one of the following:
 - i. Condensate drainage shall be sized to serve a heat pump water heater system that meets the total building hot water demand as calculated and documented by the responsible person associated with the project.
 - ii. Condensate drainage piping shall be sized to meet the requirements specified in Joint Appendix JA15.2.4.

SECTION 160.9 – MANDATORY REQUIREMENTS FOR ELECTRIC READY BUILDINGS

5. Electrical
 - A. Physical space shall be reserved on the bus system of the main switchboard or on the bus system of a distribution board to serve the future heat pump water heater system including the heat pump and temperature maintenance tanks. In addition, the physical space reserved shall be capable of providing adequate power to the future heat pump water heater in accordance with the following:
 - i. Heat Pump. Meet one of the following.
 - A. The electrical power required to power a heat pump water heater system heat pump that meets the total building hot water demand as calculated and documented by the responsible person associated with the project.

- B. The electrical power required that meets the requirements specified for the heat pump in Joint Appendix JA15.2.5.
- ii. Temperature Maintenance Tank. Meet one of the following.
 - A. The electrical power required to power a heat pump water heater system temperature maintenance tank that meets the total building hot water demand as calculated and documented by the responsible person associated with the project.
 - B. The electrical power required that meets the requirements specified for the temperature maintenance tank in Joint Appendix JA15.2.5.

NOTE: Authority: Sections 25213, 25218, 25218.5, 25402 and 25402.1, Public Resources Code. Reference: Sections 25007, 25008, 25218.5 25310, 25402, 25402.1, 25402.4, 25402.5, 25402.8 and 25943, Public Resources Code.

Section 170.1(D) – Performance Approach

D. Thermal Balancing Valve. When performance compliance requires installation of thermal balancing valves with variable speed circulation pump(s), the installation shall meet the procedures specified in Reference Residential Appendix RA4.4.3. Reserved.

Section 170.2 PRESCRIPTIVE APPROACH

(d) Domestic Hot Water Systems~~Water heating systems.~~ Water-heating systems shall meet the applicable requirements of either 1, 2, 3 or 4 below:-

~~For recirculation distribution systems serving individual dwelling units, only demand recirculation systems with manual on/off control as specified in the Reference Appendix RA4.4.9 shall be used. Recirculation system serving multiple dwelling units shall meet the requirements of Sections 110.3(c)2 and 110.3(c)5, and shall be capable of automatically controlling the recirculation pump operation based on measurement of hot water demand and hot water return temperature:~~

1. **Individual Systems.** For systems serving individual dwelling units, the water-heating system shall meet the requirement of either A, or B or C, or shall meet the performance compliance requirements of Section 170.1. For recirculation distribution systems serving individual dwelling units, only demand recirculation systems with manual on/off control as specified in the Reference Appendix RA4.4.9 shall be used.:
 - A. A single 240 volt heat pump water heater. In addition, meet the following:

- i. A compact hot water distribution system as specified in Reference Appendix RA4.4.6 in climate zones 1 and 16; and
 - ii. A drain water heat recovery system that is field verified as specified in the Reference Appendix RA3.6.9 in Climate Zone 16.
- B. A single heat pump water heater that meets the requirements of NEEA Advanced Water Heater Specification Tier 3 or higher. In addition, for climate zone 16, a drain water heat recovery system that is field verified as specified in Reference Appendix RA3.6.9.
- C. ~~A gas or propane instantaneous water heater with an input of 200,000 Btu per hour or less and no storage tank.~~

Exception 1 to Section 170.2(d)1: Multifamily buildings four habitable stories or greater may install a gas or propane instantaneous water heater with an input of 200,000 Btu per hour or less and no storage tank.

Exception 2 to Section 170.2(d)1: A 120V HPWH may be installed in place of a 240V HPWH for new dwelling unit with one bedroom or less.

2. **Central Systems.** For systems serving multiple dwelling units, the water-heating system shall meet the applicable requirement of A through F, or shall meet the performance compliance requirements of Section 170.1:

- A. For heat pump water-heating systems serving multiple dwelling units, the water-heating system shall be installed according to the manufacturer's design and installation guidelines and meet the following requirements, or meet the requirements of NEEA Advanced Water Heater Specification for commercial heat pump water heater Tier 2 or higher:

iA. The primary heat pump water heater shall be a single-pass heat pump water heater.

ii. The hot water return from the recirculation loop shall connect to a recirculation loop tank and shall not directly connect to the primary heat pump water heater inlet or the primary thermal storage tanks.

~~iiiB. The fuel source for the recirculation loop tank shall be electricity, if auxiliary heating is needed. The recirculation loop heater shall be capable of multi-pass water heating operation.~~

~~C. For systems with single pass primary heat pump water heater, the primary thermal storage tanks shall be piped in series if multiple tanks are used. For systems with multi-pass primary heat pump water heater, the primary thermal storage tanks shall be piped in parallel if multiple tanks are used.~~

ivD. The primary storage tank temperature setpoint shall be at least 135°F.

~~vE.~~ The recirculation loop tank temperature setpoint shall be at least 10°F lower than the primary thermal storage tank temperature setpoint ~~such that hot water from the recirculation loop tank is used for the temperature maintenance load before engaging the recirculation loop tank heater.~~

~~viF.~~ The minimum heat pump water heater compressor cut-off temperature shall be equal to or lower than 40°F ambient air temperature. ~~G. A recirculation system.~~

~~**Exception to Section 170.2(d)2G: Buildings with eight or fewer dwelling units.**~~

~~viiH.~~ Design documentation shall be provided in accordance with JA14.4.

~~3B.~~ For gas or propane systems serving multiple dwelling units, ~~the a central~~ water-heating system that includes the following components shall be installed:

~~iA.~~ For Climate Zones 1 through 9, gas service water-heating systems with a total installed gas water-heating input capacity of 1 MMBtu/h or greater shall have gas service water-heating equipment with a minimum thermal efficiency of 90 percent. Multiple units are allowed to meet this requirement with an input capacity-weighted average of at least 90 percent.

~~**Exception 1 to Section 170.2(d)Bi3A:**~~ Individual gas water heaters with input capacity at or below 100,000 Btu/h shall not be included in the calculations of the total system input or total system efficiency.

~~**Exception 2 to Section 170.2(d)Bi3A:**~~ If 25 percent of the annual water-heating requirement is provided by site-solar energy or site-recovered energy.

~~B. A recirculation system.~~

~~**Exception to Section 170.2(d)3B: Buildings with eight or fewer dwelling units.**~~

~~iiC.~~ A solar water-heating system meeting the installation criteria specified in Reference Residential Appendix RA4 and with a minimum solar savings fraction of either ~~i.a.~~ or ~~ii.b.~~ below:

- ~~i.~~ A minimum solar savings fraction of 0.20 in Climate Zones 1 through 9 or a minimum solar savings fraction of 0.35 in Climate Zones 10 through 16; or
- ~~ii.~~ A minimum solar savings fraction of 0.15 in Climate Zones 1 through 9 or a minimum solar savings fraction of 0.30 in Climate Zones 10 through 16. In addition, a drain water heat recovery system that is field verified as specified in the Reference Appendix RA3.6.9.

~~4C.~~ All hot water distribution piping shall be sized in accordance with the California Plumbing Code Appendix M.

~~D.~~ The central system shall have a recirculation system with mechanical or digital thermostatic master mixing valve on each distribution supply and return loop, and meet the requirements specified in the Residential Reference Appendix RA4.4.2019.

~~**Exception to Section 170.2(d)2D: Buildings with eight or fewer dwelling units.**~~

E. Insulation for hot water pipes and plumbing appurtenances shall be field verified as specified in Residential Reference Appendix RA3.6.3.

~~FE~~. A water-heating system serving multiple dwelling units determined by the Executive Director to use no more energy than the one specified in Subsection ~~1, 2 or 3~~ A or B above.

7.1.2 Section 100.1 – Definitions and Rules of Construction

SECTION 100.1(b) – DEFINITIONS AND RULES OF CONSTRUCTION

AHRI 540 is the Air-Conditioning, Heating, and Refrigeration Institute document titled “Performance Rating of Positive Displacement Refrigerant Compressors and Compressor Units,” 2020 (AHRI Standard 540-2020).

AIR-TO-WATER HEAT PUMP (AWHP) is a factory-made packaged heat pump system containing one or more compressors, and heat exchangers for transferring heat between refrigerant and air, as well as between refrigerant and water, and various other components. Its primary purpose is to generate heated or cooled water to meet space conditioning loads, ~~and/or~~ ~~and~~ domestic hot water loads, or both.

WATER HEATER definitions include the following:

CONSUMER WATER HEATER is a water heater that meets the definition of a consumer product under USDOE 10 CFR 430.

HEAT PUMP WATER HEATER (HPWH) is a water heater that transfers thermal energy from one temperature level to another temperature level for the purpose of heating water, including all ancillary equipment such as fans, storage tanks, pumps, or controls necessary for the device to perform its function.

INTEGRATED HEAT PUMP WATER HEATER is a HPWH which has all components, including fans, storage tanks, pumps, or controls necessary for the device to perform its function contained in a single factory-made assembly.

SPLIT-REFRIGERANT HEAT PUMP WATER HEATER is a HPWH which has a single outdoor section and one or more indoor sections connected to the outdoor section via a refrigerant circuit.

SPLIT-HYDRONIC HEAT PUMP WATER HEATER is a HPWH that consists of multiple separate sections. One section houses all the refrigerant components, while one or more additional sections are designated for water storage. These sections are interconnected through a hydronic circuit.

MULTI-PASS WATER HEATER is a water heater which the cold water passes through multiple times. The water temperature increases with each pass, until the storage tank reaches the intended storage temperature.

SINGLE-PASS WATER HEATER is a water heater which the cold water passes through once and is heated to the intended use temperature.

NET FREE AREA (NFA) is the total unobstructed area within the air gaps between louver and grille slats in a vent, allowing the passage of air. The narrowest distance between two slats, perpendicular to the surface of both slats is the air gap height. The narrowest width of the gap is the air gap width. The NFA is the air gap height multiplied by the air gap width multiplied by the total number of air gaps between slats in the vent.

DOMESTIC HOT WATER SYSTEM APPURTENANCE are all elements that are in series in a domestic hot water distribution system, including fittings (elbows, tees, flanges, etc.), pumps,

valves (isolation, mixing, balancing, check, etc.), pipe supports and hangers, strainers, hose bibs, coil u-bends, meters, sensors, heat exchangers and air separators.

7.2 Reference Appendices

RA3.6 Field Verification of Water Heating Systems

RA3.6.2 ~~HERS-Verified Pipe Insulation Requirements for all Hot Water Distribution~~ Single Dwelling Systems

~~Unless otherwise stated, the HERS-ECC-rater shall verify that all domestic hot water piping insulation must meet the insulation requirements specified in §150.0(j). The rater shall visually verify the following:~~

(a) All domestic hot water piping shall be insulated as specified in Section 609.12 of the California Plumbing Code.

~~A. Pipe insulation shall fit tightly to the pipe and all elbows and tees shall be fully insulated. No piping should be visible due to insulation voids with the exception of the last segment of piping that penetrates walls and delivers hot water to the sink, appliance, etc. All domestic hot water piping shall be insulated as specified in Section 609.11 of the California Plumbing Code. In addition, the following piping conditions shall have a minimum insulation wall thickness of 1 inch:~~

(b)

~~B. The first five feet of cold water piping from storage gas water heaters.~~

~~C. All hot water piping with a nominal diameter between 3/4 inch (19 millimeter) and 1 inch.~~

~~D. All hot water piping less than 3/4 inch in diameter that is associated with a domestic hot water recirculation system or leading to the kitchen fixtures.~~

~~E. (d) All underground hot water piping.~~

(c) In addition, all piping below grade must be installed in a waterproof and non-crushable casing or sleeve that allows for installation, removal and replacement of the enclosed pipe and insulation. The internal cross-section or diameter of the casing or sleeve shall be large enough to allow for insulation of the hot water piping.

~~(e) Piping from the heating source to storage tank or between tanks.~~

(d) D. Pipe insulation may be omitted where hot water distribution piping is buried within attic, crawlspace or wall insulation, as described below. :

1. In attics and crawlspaces the insulation shall completely surround the pipe with at least 1 inch of insulation and the pipe shall be completely covered with at least 4 inches of insulation further away from the conditioned space.
- ~~2. In walls, the insulation must completely surround the pipe with at least 1 inch of insulation. If burial within the insulation does not meet these specifications, then this exception does not apply, and the section of pipe not meeting the specifications must be insulated as specified in §150.0(j).~~

RA4.4 Water Heating Measures

RA4.4.3 ~~Reserved for future use~~ Thermostatic Balancing Valve

To receive the thermostatic balancing valve credit, calculations shall be completed that demonstrate that the length of the return piping portion of the domestic hot water recirculation loop does not exceed 160 feet. If the domestic hot water has multiple recirculation pipe loops, the length of any hot water return pipe shall not exceed 160 feet to receive credit.

A variable speed circulation pump with pump differential pressure control shall be installed. The circulation pump design flow rate should be calculated to meet the design hot water return temperature based on the calculated distribution system heat losses and the design hot water supply temperature. The circulation pump specified should be the smallest pump required to meet the design flow rate as calculated and documented by the responsible person associated with the project.

Each thermostatic balancing valve shall be installed after the last fixture on the hot water supply riser it serves. As part of the installer's start-up procedure, the installer shall perform the following:

- (1) Close all fixtures in the domestic water system.
- (2) Start the circulation pump at a constant speed, targeting the circulation pump design flow, and allow the system 60 minutes to warm up.
- (3) Verify that the temperature at the last riser does not exceed 120 °F.
- (4) If the temperature at the last riser exceeds 120 °F, adjust the pump speed down and repeat the procedure, allowing 30 minutes for warm up.
- (5) Once the temperature at the last riser is equal to or less than 120 °F, record the pump differential pressure and set the pump into differential pressure control mode using the recorded differential pressure as the set point.

Multiple Dwelling Units: Master Mixing Valves~~Central DHW systems serving a building with~~

~~more than eight dwelling units shall have at least two recirculation loops, each serving roughly the same number of dwelling units. Unique building sections may have additional recirculation loops. These recirculation loops may be connected to the same water heating equipment or be connected to independent water heating equipment. This credit may be taken in combination with recirculation system.~~

For central systems with hot water piping serving multiple dwelling units master mixing valves (MMV) shall meet the following

RA4.4.19.1 Plumbing Plans

The plumbing plans shall include the following MMV specification at a minimum:

- (1) Manufacturer’s installation and commissioning instructions and plumbing drawings.
- (2) MMV conforms to the American Society of Sanitation Engineers (ASSE) 1017-2009 standard, Performance Requirements for Temperature Actuated Mixing Valves for Hot Water Distribution Systems.
- (3) Water mixing parameters and associated values:
 1. Input parameters
 - A. Recirculation pump flow rate
 - B. Mixing valve outlet water temperature
 - C. Recirculation return water temperature
 - D. Mixing valve hot inlet water temperature
 2. Calculated parameters
 - A. Percentage of water flow returning to cold side of MMV
 - B. Percentage of water flow returning to hot side of MMV
 3. Manufacturer’s operating parameter
 - A. Maximum water mixing ratio

These input parameters shall be used to calculate percentage of water flow on cold side and hot side of MV during recirculation water flow only condition to determine if the water mixing ratio exceeds mixing capability of the specified master mixing valve. If the calculated water flow ratio to the MMV inlet exceeds manufacturer’s recommendations for that valve, the designer shall provide instructions to commission the balancing valve to eliminate temperature creep to mitigate scalding risk after periods of no water draw.

RA4.4.19.2 Installation

Installation of MMV shall meet manufacturer’s instruction and the following requirements at a minimum:

- (a) The MMV shall be installed on the central heating plant hot water supply outlet header leading to the recirculation loop.
- (b) Check valves installed on the recirculation return line and cold-water line to inlet cold connection of MMV and on recirculation return piping leading back to storage tank or water heater.
- (c) Isolation valves installed on the inlet cold water, inlet recirculation return, inlet hot and outlet connections to MMV and on recirculation return piping connection to storage tank or water heater.
- (d) Balancing valve installed on the recirculation return piping to the water heater for MMVs that cannot 100% close the hot inlet port during operation.
- (e) Thermometers installed on the outlet of the MMV and on the recirculation return line next to the water pump.

RA4.4.19.3 Startup

- (a) Startup testing of MMV during recirculation only operation
 1. Close all hot fixtures in the domestic water system.
 2. Ensure that the water heater is operational and idling with storage tank plumbed to the mixing valve and meeting the hot inlet temperature specified in the plumbing plans.
 3. Start the recirculation pump and set mixed outlet temperature or setpoint temperature on the MMV. Start the circulation pump at the specified water flow rate and adjust as needed to meet recirculation return temperature specified in the plumbing plans.
 4. Let distribution system warm up and stabilize for 30 minutes and adjust mixing parameters as needed to realign with values in plumbing plans.
 5. Let the recirculation pump operate for three hours without any water draws to ensure there is no temperature creep.
 6. If during or after the three-hour period the MMV outlet and return temperature stays elevated by greater than 2°F and doesn't return back to the specified temperature, then make necessary adjustments to the MMV. If temperature creep persists with mechanical MMV, adjust the balancing valve as necessary on the recirculation return line leading back to the water heater to ensure average MMV outlet temperature meets the specified temperature.
 7. If adjustments are made to MMV or balancing valve in Step 6, then repeat Step 5.

- (b) Startup testing of MMV for a combination of recirculation and hot water draws.

1. Once the MMV is operational in a closed loop, make a water draw for 10 minutes using one of the following options:
 - a. With a shower operating at full flow at every: three dwelling units in a building with 15 or fewer dwelling units, five dwelling units in a building with 16 to 30 dwelling units, eight dwelling units in a building with 31 to 60 dwelling units, ten dwelling units in a building than 60 to 200 dwelling units, twenty dwelling units in a building with more than 200 dwelling units.
 - b. The hot water valve on a hose bib, mop sink, or other fixture on the branch line or location on the hot water distribution line is opened to a draw volume of 1 gpm for every: three dwelling units in a building with 15 or fewer dwelling units, five dwelling units in a building with 16 to 30 dwelling units, eight dwelling units in a building with 31 to 60 dwelling units, ten dwelling units in a building than 60 to 200 dwelling units, twenty dwelling units in a building with more than 200 dwelling units.
2. Monitor recirculation return temperature on the thermometer during the 10-minute draw period and ensure design return water temperature is maintained at the specified temperature documented in the plumbing plans.
3. If the recirculation return temperature falls more than 5°F below the specified temperature during the draw period, then adjust MMV setup to ensure compliance.

JA15 Requirements for Electric Ready Water Heating

JA 15.1 Purpose and Scope

Joint Appendix JA15 provides sizing requirements, for electric ready infrastructure installed with gas or propane water heating systems to meet the requirement for electric readiness specified in Title 24, Part 6, Section 160.9(e)

JA 15.2 Electric Ready Requirements

JA15.2.1 Heat Pump Space Requirements

Space shall be reserved for future installation of central heat pump water heaters. The space reserved shall meet the following requirements:

- (a) If the gas water heating system has an input capacity less than 200,000 Btu per hour, the minimum space reserved for the heat pump shall be 2.0 square feet per 10,000 Btu per hour input of the gas or propane water heating system, and the minimum linear dimension of the space reserved shall be 48 linear inches.
- (b) If the gas water heating system has an input capacity greater than or equal to 200,000 Btu per hour, the minimum space reserved for the heat pump shall be 3.6 square feet per 10,000 Btu per hour input of the gas or propane water heating system, and the minimum linear dimension of the space reserved shall be 84 linear inches.

JA15.2.2 Storage Tank Space Requirements

Space shall be reserved for future installation of hot water storage tanks. The space reserved shall meet the following requirements:

- (a) If the input capacity of the gas water heating system is less than 200,000 Btu per hour, the minimum space reserved for the storage and temperature maintenance tanks shall be 4.4 square feet per 10,000 Btu per hour input of the gas or propane water heating system.
- (b) If the input capacity of the gas water heating system is greater than or equal to 200,000 Btu per hour, the minimum physical space reserved for the storage and temperature maintenance tanks shall be 3.1 square feet per 10,000 Btu per hour input of the gas or propane water heating system.

JA15.2.3 Ventilation Requirements

The reserved pathway and penetrations through the building envelope shall meet the following requirements:

- (a) If the input capacity of the gas water heating system is less than 200,000 Btu per hour, the minimum air flow rate shall be 70 CFM per 10,000 Btu per hour input of the gas or propane water heating system and the total external static pressure drop of ductwork and louvers shall not exceed 0.17 inches water column when the future heat pump water heater is installed.
- (b) If the input capacity of the gas water heating system is greater than or equal to 200,000 Btu per hour, the minimum air flow rate shall be 420 CFM per 10,000 Btu per hour input of the gas or propane water heating system and the total external

static pressure drop of ductwork and louvers shall not exceed 0.17 inches water column when the future heat pump water heater is installed.

JA15.2.4 Condensate Drainage Piping Requirements

The condensate drainage piping shall meet the following requirements:

- (a) If the input capacity of the gas water heating system is less than 200,000 Btu per hour, condensate drainage shall be sized for 0.2 tons of refrigeration capacity per 10,000 Btu per hour input.
- (b) If the input capacity of the gas water heating system is greater than or equal to 200,000 Btu per hour, condensate drainage shall be sized for 0.7 tons of refrigeration capacity per 10,000 Btu per hour input.

JA15.2.5 Electrical Requirements

The electrical system serving the heat pump shall meet the following requirements:

- (a) If the input capacity of the gas water heating system is less than 200,000 Btu per hour, provide 0.1 kVA per 10,000 Btu per hour input.
- (b) If the input capacity of the gas water heating system is greater than or equal to 200,000 Btu per hour, provide 1.1 kVA per 10,000 Btu per hour input.

The electrical system serving the temperature maintenance tank shall meet the following requirements:

- (c) If the input capacity of the gas water heating system is less than 200,000 Btu per hour, provide 1.0 kVA per 10,000 Btu per hour input.
- (d) If the input capacity of the gas water heating system is greater than or equal to 200,000 Btu per hour, provide 0.6 kVA per 10,000 Btu per hour input.

8. Bibliography

Gary Klein and Associates, Inc. 2024. “Comments on Consumer Product Heat Pump Water Heaters.”

<https://efiling.energy.ca.gov/GetDocument.aspx?tn=256524&DocumentContentId=92335>

CA Statewide Utility Codes and Standards Enhancement Team. 2024. “CA Statewide Utility Codes and Standards Enhancement Team Comments on 45-Day Express Terms.”

<https://efiling.energy.ca.gov/GetDocument.aspx?tn=256540&DocumentContentId=92362>

CA Utility CASE Team and Compliance Improvement Team, 2024. “CA Utility CASE Team and Compliance Improvement Team Comments on 45-Day Express Terms.”

<https://efiling.energy.ca.gov/GetDocument.aspx?tn=256172&DocumentContentId=91953>

Attachment 1: Public Comments Submitted by the Statewide CASE Team

Attachment 1 presents comments that the Statewide CASE Team submitted to the CEC’s docket that are relevant to this measure.

257749	7/15/2024	<u>CA Statewide Utility Codes and Standards Enhancement Team Comments - CASE Team Additional Comments to 45-Day Express Terms</u>
257467	6/27/2024	<u>CA Statewide Utility Codes and Standards Enhancement Team Comments - 2025 Title 24 CASE Team comments on 15-Day Express Terms</u>
256540	5/24/2024	<u>CA Statewide Utility Codes and Standards Enhancement Team Comments on 45-Day Express Terms - May 24 2024</u>

Attachment 2: Final CASE Report

The final version of the CASE Report is provided in full in Attachment 2 to this report.

Multifamily Domestic Hot Water



Multifamily Domestic Hot Water (DHW)
Jingjuan “Dove” Feng, Amin Delagah, Jose Garcia – TRC
James Haile – Frontier Energy

August 2023
Revised January 2024
Final CASE Report



This report was prepared by the California Statewide Codes and Standards Enhancement (CASE) Program that is funded, in part, by California utility customers under the auspices of the California Public Utilities Commission.

Copyright 2023 Pacific Gas and Electric Company, Southern California Edison, San Diego Gas & Electric Company, Los Angeles Department of Water and Power, and Sacramento Municipal Utility District. All rights reserved, except that this document may be used, copied, and distributed without modification.

Neither Pacific Gas and Electric Company, Southern California Edison, San Diego Gas & Electric Company, Los Angeles Department of Water and Power, Sacramento Municipal Utility District or any of its employees makes any warranty, express or implied; or assumes any legal liability or responsibility for the accuracy, completeness or usefulness of any data, information, method, product, policy or process disclosed in this document; or represents that its use will not infringe any privately-owned rights including, but not limited to, patents, trademarks or copyrights.

Document Information

Category: Codes and Standards

Keywords: Statewide Codes and Standards Enhancement (CASE) Initiative; California Statewide Utility Codes and Standards Team; Codes and Standards Enhancements; 2025 California Energy Code; 2025 Title 24, Part 6; California Energy Commission; energy efficiency; Central Heat Pump Water Heater, Unitary Heat Pump Water Heater, Electric-Ready, Domestic Hot Water Distribution System, California Plumbing Code Appendix M, Pipe Insulation, Balancing Valve, Master Mixing Valve.

Authors: Jingjuan “Dove” Feng, Amin Delagah, Jose Garcia, Catherine Chappell, Yiyi Chu, Daniel Hacking, Ben Seeley, Debrudra Mitra (TRC Companies), James Haile (Frontier Energy)

Prime Contractor: TRC Companies

Project Management: California Statewide Utility Codes and Standards Team: Pacific Gas and Electric Company, Southern California Edison, San Diego Gas & Electric Company, Sacramento Municipal Utility District, and Los Angeles Department of Water and Power.

Revision as of 01/10/2024: This document contains the following revisions:
The values in Table 21, Residential Construction & Remodel Economic Impacts were corrected.
The dollar units have been revised to exclude the term 'Millions' in the following tables: 62, 63, 64, 113, 114, 115, 116, 117, 162, 163, 164, 205, 272, 273, 334, 335, and 336.
Tables formerly known as 205, 206, 207, 274, 275 in TN 251804 were deleted.

Table of Contents

- Executive Summary** _____ **xxxvi**
- 1. Introduction** _____ **1**
- 2. Addressing Energy Equity and Environmental Justice** _____ **5**
 - 2.1 General Equity Impacts..... 5
 - 2.2 Specific Impacts of the Proposal..... 9
- 3. CPC Appendix M Pipe Sizing** _____ **11**
 - 3.1 Measure Description 11
 - 3.2 Market Analysis 18
 - 3.3 Energy Savings..... 34
 - 3.4 Cost and Cost-Effectiveness..... 43
 - 3.5 Annual Statewide Impacts 55
 - 3.6 Addressing Energy Equity and Environmental Justice..... 59
- 4. Pipe Insulation Enhancement** _____ **60**
 - 4.1 Measure Description 60
 - 4.2 Market Analysis 74
 - 4.3 Energy Savings..... 89
 - 4.4 Cost and Cost-Effectiveness..... 98
 - 4.5 Annual Statewide Impacts 114
 - 4.6 Addressing Energy Equity and Environmental Justice..... 117
- 5. Thermostatic Balancing Valves** _____ **118**
 - 5.1 Measure Description 118
 - 5.2 Market Analysis 125
 - 5.3 Energy Savings..... 142
 - 5.4 Cost and Cost-Effectiveness..... 150
 - 5.5 Annual Statewide Impacts 162
 - 5.6 Addressing Energy Equity and Environmental Justice..... 166
- 6. Master Mixing Valves** _____ **167**
 - 6.1 Measure Description 167
 - 6.2 Market Analysis 176
 - 6.3 Energy Savings..... 193
 - 6.4 Cost and Cost-Effectiveness..... 201
 - 6.5 Annual Statewide Impacts 213
 - 6.6 Addressing Energy Equity and Environmental Justice..... 216
- 7. Central HPWH Clean-up** _____ **217**
 - 7.1 Measure Description..... 217

7.2	Market Analysis	225
7.3	Energy Savings.....	253
7.4	Cost and Cost-Effectiveness.....	272
7.5	Annual Statewide Impacts	289
7.6	Addressing Energy Equity and Environmental Justice.....	289
8.	Individual HPWH Ventilation _____	291
8.1	Measure Description	291
8.2	Market Analysis	298
8.3	Energy Savings.....	316
8.4	Cost and Cost-Effectiveness.....	326
8.5	Annual Statewide Impacts	349
8.6	Addressing Energy Equity and Environmental Justice.....	354
9.	Individual DHW Electric Ready _____	355
9.1	Measure Description	355
9.2	Market Analysis	361
9.3	Energy Savings.....	380
9.4	Cost and Cost-Effectiveness.....	380
9.5	Annual Statewide Impacts	386
9.6	Addressing Energy Equity and Environmental Justice.....	387
10.	Central DHW Electric Ready _____	388
10.1	Measure Description	388
10.2	Market Analysis	394
10.3	Energy Savings.....	415
10.4	Cost and Cost-Effectiveness.....	415
10.5	Annual Statewide Impacts	427
10.6	Addressing Energy Equity and Environmental Justice.....	427
11.	Proposed Revisions to Code Language _____	429
11.1	Guide to Markup Language	429
11.2	Standards	429
11.3	Reference Appendices.....	444
11.4	ACM Reference Manual.....	452
11.5	Compliance Forms.....	474
12.	Bibliography _____	484
Appendix A: Statewide Savings Methodology _____		496
Appendix B: Embedded Electricity in Water Methodology _____		506
Appendix C: California Building Energy Code Compliance Software Specification		
508		

Appendix D: Environmental Analysis	515
Appendix E: Discussion of Impacts of Compliance Process on Market Actors	520
Appendix F: Summary of Stakeholder Engagement	536
Appendix G: Energy Cost Savings in Nominal Dollars	542
Appendix H: Energy Impact Analysis Methodology Details	583
Appendix I: Prototypes and Basis of Design CPC Appendix A Pipe Sizing Methodology	594
Appendix J: Prototypes and Basis of Design CPC Appendix M Pipe Sizing Methodology	605
Appendix K: Central HPWH Clean-up Basis of Design, Modeling and Cost Analysis Details	614
Appendix L: Individual HPWH Ventilation Detail	628
Appendix M: Individual DHW and Central DHW Electric Ready Basis of Design and Cost Details	638
Appendix N: Individual HPWH Ventilation – Nonresidential Analysis Memo	665
Appendix O: Automatic Balancing Valve Lab Testing	671
Appendix P: Demand Recirculation Control for Circulation Systems Serving Multiple Dwelling Units	676
Appendix Q: Master Mixing Valve Lab Testing	678
Appendix R: Building Level Electric Readiness Cleanup	684

List of Tables

Table 1: Scope of Code Change Proposal – Appendix M	xxxviii
Table 2: Summary of Impacts for CPC Appendix M	xli
Table 3: Scope of Code Change Proposal – Pipe Insulation Enhancement	xliv
Table 4: Summary of Impacts for Pipe Insulation Enhancement	xlvii
Table 5: Scope of Code Change Proposal – Require Balance Valves	li
Table 6: Summary of Impacts for Thermostatic Balancing Valves	liii
Table 7: Scope of Code Change Proposal – Master Mixing Valves	lviii
Table 8: Summary of Impacts for Master Mixing Valves	lx
Table 9: Scope of Code Change Proposal – Central HPWH Clean-up	lxiv
Table 10: Scope of Code Change Proposal – Individual HPWH Ventilation	lxxi
Table 11: Summary of Impacts for Individual HPWH Ventilation	lxxv

Table 12: Scope of Code Change Proposal - Individual DHW Electric Ready Clean-up	lxxviii
Table 13: Scope of Code Change Proposal - Central DHW Electric Ready	lxxxiii
Table 14: California Construction Industry, Establishments, Employment, and Payroll in 2022 (Estimated)	22
Table 15: Specific Subsectors of the California Residential Building Industry by Subsector in 2022 (Estimated)	23
Table 16: California Building Designer and Energy Consultant Sectors in 2022 (Estimated)	25
Table 17: California Housing Characteristics in 2021	26
Table 18: Distribution of California Housing by Vintage in 2021 (Estimated)	26
Table 19: Owner- and Renter-Occupied Housing Units in California by Income in 2021 (Estimated)	27
Table 20: Employment in California State and Government Agencies with Building Inspectors in 2022 (Estimated)	28
Table 21: Estimated Impact that Adoption of the Proposed Measure would have on the California Residential Construction Sector	30
Table 22: Estimated Impact that Adoption of the Proposed Measure would have on the California Building Designers and Energy Consultants Sectors	30
Table 23: Estimated Impact that Adoption of the Proposed Measure would have on California Building Inspectors	31
Table 24: Net Domestic Private Investment and Corporate Profits, U.S.	32
Table 25: Key Assumptions for Assessing Energy Impact of Using CPC Appendix M for Pipe Sizing	36
Table 26: Prototype Buildings Used for Energy, Demand, Cost, and Environmental Impacts Analysis	38
Table 27: Modifications Made to Standard Design in Each Prototype to Simulate Proposed Code Change	39
Table 28: Annual Electricity Savings (kWh) Per Dwelling Unit by Climate Zone (CZ) – HPWH-AppM	41
Table 29: Annual Peak Demand Reduction (kW) Per Dwelling Unit by Climate Zone (CZ) – HPWH-AppM	41
Table 30: Annual Source Energy Savings (kBtu) Per Dwelling Unit by Climate Zone (CZ) – HPWH-AppM	41
Table 31: Annual LSC Savings (kBtu) Per Dwelling Unit by Climate Zone (CZ) – HPWH-AppM	41

Table 32: Annual Natural Gas Savings (kBtu) Per Dwelling Unit by Climate Zone (CZ) – Gas-AppM.....	42
Table 33: Annual Source Energy Savings (kBtu) Per Dwelling Unit by Climate Zone (CZ) - Gas-AppM.....	42
Table 34: Annual LSC Savings (kBtu) Per Dwelling Unit by Climate Zone (CZ) – Gas-AppM.....	42
Table 35: Present Value LSC Savings Per Dwelling Unit Over 30-Year Period of Analysis – New Construction & Additions – LowRiseGarden – HPWH-AppM.....	44
Table 36: Present Value LSC Savings Per Dwelling Unit Over 30-Year Period of Analysis – New Construction & Additions – LoadedCorridor – HPWH-AppM	44
Table 37: Present Value LSC Savings Per Dwelling Unit Over 30-Year Period of Analysis – New Construction & Additions – MidRiseMixedUse – HPWH-AppM	45
Table 38: Present Value LSC Savings Per Dwelling Unit Over 30-Year Period of Analysis – New Construction & Additions – HighRiseMixedUse – HPWH-AppM....	45
Table 39: 2026 Present Value LSC Savings Per Dwelling Unit Over 30-Year Period of Analysis – New Construction & Additions – LowRiseGarden – Gas-AppM.....	46
Table 40: 2026 Present Value LSC Savings Per Dwelling Unit Over 30-Year Period of Analysis – New Construction & Additions – LoadedCorridor – Gas-AppM.....	46
Table 41: 2026 Present Value LSC Savings Per Dwelling Unit Over 30-Year Period of Analysis – New Construction & Additions – MidRiseMixedUse – Gas-AppM.....	47
Table 42: 2026 Present Value LSC Savings Per Dwelling Unit Over 30-Year Period of Analysis – New Construction & Additions – HighRiseMixedUse – Gas-AppM	47
Table 43: Total Length (Feet) of Each Pipe Size for CPC Appendix A Base Case and Appendix M Proposed Case Design	49
Table 44: Material and Labor Costs (Gas Plant)	51
Table 45: Material and Labor Costs (HPWH Plant).....	52
Table 46: Incremental Cost Per Prototype - Gas-AppM	52
Table 47: Incremental Cost Per Prototype - HPWH-AppM.....	52
Table 48: 30-Year Cost-Effectiveness Summary Per Dwelling Unit – New Construction – HPWH-AppM.....	54
Table 49: 30-Year Cost-Effectiveness Summary Per Dwelling Unit - New Construction – Additions - Gas-AppM	55
Table 50: Statewide Energy and Energy Cost Impacts – New Construction – AppM....	56
Table 51: Annual Statewide GHG Emissions Impacts – CPC Appendix M	57
Table 52: Impacts on Water Use and Embedded Electricity in Water – CPC Appendix M	58

Table 53: Annual Statewide Impacts on Material Use – HPWH – CPC Appendix M.....	58
Table 54: Annual Statewide Impacts on Material Use – Gas – CPC Appendix M	58
Table 55: California Construction Industry, Establishments, Employment, and Payroll in 2022 (Estimated).....	77
Table 56: Specific Subsectors of the California Residential Building Industry by Subsector in 2022 (Estimated)	78
Table 57: California Building Designer and Energy Consultant Sectors in 2022 (Estimated).....	79
Table 58: California Housing Characteristics in 2021	80
Table 59: Distribution of California Housing by Vintage in 2021 (Estimated)	81
Table 60: Owner- and Renter-Occupied Housing Units in California by Income in 2021 (Estimated).....	81
Table 61: Employment in California State and Government Agencies with Building Inspectors in 2022 (Estimated).....	83
Table 62: Estimated Impact that Adoption of the Proposed Measure would have on the California Residential Construction	85
Table 63: Estimated Impact that Adoption of the Proposed Measure would have on the California Building Designers and Energy Consultants	85
Table 64: Estimated Impact that Adoption of the Proposed Measure would have on California Building Inspectors.....	86
Table 65: Net Domestic Private Investment and Corporate Profits, U.S.	87
Table 66: Key Assumptions for Assessing Energy Impact of Insulation Enhancement for New Construction	90
Table 67: Prototype Buildings Used for Energy, Demand, Cost, and Environmental Impacts Analysis	92
Table 68: Modifications Made to Standard Design in Each Prototype to Simulate Proposed Code Change.....	93
Table 69: Resulting Pipe Heat Loss Savings after Modeling Proposed Code Change .	94
Table 70: Annual Electricity Savings (kWh) Per Dwelling Unit – HPWH-Pipe Insulation	96
Table 71: Annual Peak Demand Reduction (kW) Per Dwelling Unit – HPWH-Pipe Insulation.....	96
Table 72: Annual Source Energy Savings (kBtu) Per Dwelling Unit – HPWH-Pipe Insulation.....	96
Table 73: Annual LSC Savings (2026 PV\$) Per Dwelling Unit – HPWH-Pipe Insulation	96

Table 74: Annual Natural Gas Savings (kBtu) Per Dwelling Unit – Gas-Pipe Insulation	97
Table 75: Annual Source Energy Savings (kBtu) Per Dwelling Unit – Gas-Pipe Insulation.....	97
Table 76: Annual LSC Savings (2026 PV\$) Per Dwelling Unit – Gas-Pipe Insulation...	97
Table 77: 2026 PV 30-year LSC Savings – Per Dwelling Unit – New Construction and Additions – LowRiseGarden – HPWH-Pipe Insulation	99
Table 78: 2026 PV 30-year LSC Savings – Per Dwelling Unit – New Construction and Additions – LoadedCorridor – HPWH-Pipe Insulation	99
Table 79: 2026 PV 30-year LSC Savings – Per Dwelling Unit – New Construction and Additions – MidRiseMixedUse – HPWH-Pipe Insulation	100
Table 80: 2026 PV 30-year LSC Savings – Per Dwelling Unit – New Construction and Additions – HighRiseMixedUse – HPWH-Pipe Insulation.....	100
Table 81: 2026 PV 30-year LSC Savings – Per Dwelling Unit – New Construction and Additions – LowRiseGarden – Gas-Pipe Insulation.....	101
Table 82: 2026 PV 30-year LSC Savings – Per Dwelling Unit – New Construction and Additions – LoadedCorridor – Gas-Pipe Insulation	101
Table 83: 2026 PV 30-year LSC Savings – Per Dwelling Unit – New Construction and Additions – MidRiseMixedUse – Gas-Pipe Insulation.....	102
Table 84: 2026 PV 30-year LSC Savings – Per Dwelling Unit – New Construction and Additions – HighRiseMixedUse – Gas-Pipe Insulation.....	102
Table 85: Total Length (Feet) of Each Pipe Size - Base and Proposed Case Design.	104
Table 86: Total Appurtenance (Piping Specialty) Count - Distribution System.....	105
Table 87: Total Appurtenance (Piping Specialty) Count - Gas Heating Plant System.	106
Table 88: Total Appurtenance (Piping Specialty) Count - HPWH Heating Plant System	107
Table 89: Material and Labor Costs for Base Case (Gas Plant).....	108
Table 90: Material and Labor Costs for Proposed Case (Gas Plant)	108
Table 91: Material and Labor Costs for Base Case (HPWH Plant)	108
Table 92: Material and Labor Costs for Proposed Case (HPWH Plant)	109
Table 93: Proposed Case Incremental Cost Per Prototype (Gas Plant).....	109
Table 94: Proposed Case Incremental Cost Per Prototype (HPWH Plant)	109
Table 95: Total Verification Hours for Inspection by Prototype.....	110
Table 96: Number of Trips Required by Prototype – First level of piping with sampling of risers	111
Table 97: Total Verification Cost by Prototype	111
Table 98: Total Incremental Cost by Prototype Gas Heating Plant	112

Table 99: Total Incremental Cost by Prototype HP Heating Plant.....	112
Table 100: 30-Year Cost-Effectiveness Summary Per Dwelling Unit – New Construction – HPWH-Pipe Insulation.....	113
Table 101: 30-Year Cost-Effectiveness Summary Per Dwelling Unit – New Construction – Gas-Pipe Insulation.....	114
Table 102: Statewide Energy and Energy Cost Impacts – New Construction and Additions - Pipe Insulation.....	115
Table 103: First Year Statewide–GHG Emissions Impacts – Pipe Insulation.....	116
Table 104: Annual Statewide Impacts on Material Use – HPWH plant	117
Table 105: Annual Statewide Impacts on Material Use – Gas Water Heater plant	117
Table 106: California Construction Industry, Establishments, Employment, and Payroll in 2022 (Estimated).....	129
Table 107: Specific Subsectors of the California Residential Building Industry by Subsector in 2022 (Estimated).....	130
Table 108: California Building Designer and Energy Consultant Sectors in 2022 (Estimated).....	131
Table 109: California Housing Characteristics in 2021 ^a	132
Table 110: Distribution of California Housing by Vintage in 2021 (Estimated)	133
Table 111: Owner- and Renter-Occupied Housing Units in California by Income in 2021 (Estimated).....	133
Table 112: Employment in California State and Government Agencies with Building Inspectors in 2022 (Estimated).....	135
Table 113: Estimated Impact that Adoption of the Proposed Measure would have on the California Residential Construction Sector	136
Table 114: Estimated Impact that Adoption of the Proposed Measure would have on the California Residential Remodel Sector.....	137
Table 115: Estimated Impact that Adoption of the Proposed Measure would have on the California Building Designers and Energy Consultants	137
Table 116: Estimated Impact that Adoption of the Proposed Measure would have on California Building Inspectors.....	138
Table 117: Estimated Impact that Adoption of the Proposed Measure would have on Discretionary Spending by California Residents	138
Table 118: Net Domestic Private Investment and Corporate Profits, U.S.	139
Table 119: Key Assumptions for Assessing Energy Impact of Automatic Balancing Valves	143

Table 120: Prototype Buildings Used for Energy, Demand, Cost, and Environmental Impacts Analysis	145
Table 121: Modifications Made to Standard Design in Each Prototype to Simulate Proposed Code Change.....	146
Table 122: Annual Electricity Savings (kWh) Per Dwelling Unit by Climate Zone (CZ) - HPWH-Balance-Valve-Temp-120	149
Table 123: Annual Peak Demand Reductio (kW) Per Dwelling Unit - HPWH-Balance-Valve-Temp-120.....	149
Table 124: Annual Source Energy Savings (kBtu) Per Dwelling Unit - HPWH-Balance-Valve-Temp-120.....	149
Table 125: Annual LSC Savings (kBtu) Per Dwelling Unit - HPWH-Balance-Valve-Temp-120.....	149
Table 126: Annual Natural Gas Savings (kBtu) Per Dwelling Unit - Gas-Balance-Valve-Temp-120.....	149
Table 127: Annual Source Energy Savings (kBtu) Per Dwelling Unit - Gas-Balance-Valve-Temp-120.....	149
Table 128: Annual LSC Savings (kBtu) Per Dwelling Unit - Gas-Balance-Valve-Temp-120	149
Table 129: 2026 Present Value LSC Savings Per Dwelling Unit Over 30-Year Period of Analysis – New Construction & Additions – LowRiseGarden - HPWH-Balance-Valve-Temp-120.....	151
Table 130: 2026 Present Value LSC Savings Per Dwelling Unit Over 30-Year Period of Analysis – New Construction & Additions – LoadedCorridor - HPWH-Balance-Valve-Temp 120.....	151
Table 131: 2026 Present Value LSC Savings Per Dwelling Unit Over 30-Year Period of Analysis – New Construction & Additions – LowRiseGarden - Gas-Balance-Valve-Temp-120.....	152
Table 132: 2026 Present Value LSC Savings Per Dwelling Unit Over 30-Year Period of Analysis – New Construction & Additions – LoadedCorridor - Gas-Balance-Valve-Temp-120.....	152
Table 133: 2026 Present Value LSC Savings Per Dwelling Unit Over 30-Year Period of Analysis – Alterations – LowRiseGarden - HPWH-Balance-Valve-Temp-120.....	153
Table 134: 2026 Present Value LSC Savings Per Dwelling Unit Over 30-Year Period of Analysis – Alterations – LoadedCorridor - HPWH-Balance-Valve-Temp-120	153
Table 135: 2026 Present Value LSC Savings Per Dwelling Unit Over 30-Year Period of Analysis – Alterations – LowRiseGarden - Gas-Balance-Valve-Temp-120.....	154

Table 136: 2026 Present Value LSC Savings Per Dwelling Unit Over 30-Year Period of Analysis – Alterations – Loaded Corridor - Gas-Balance-Valve-Temp-120.....	154
Table 137: Total Component Count and Type: Base Case	156
Table 138: Total Component Count and Type: Proposed Case.....	156
Table 139: Material and Labor Costs for Base Case.....	157
Table 140: Material and Labor Costs for Proposed Case-TBV	157
Table 141: Incremental Costs for Base Case vs Proposed Case-TBV	157
Table 142: Replacement Material and Labor Costs for Base Case.....	158
Table 143: Replacement Material and Labor Costs for Proposed Case	158
Table 144: Incremental Replacement Costs for Base Case vs Proposed Case.....	158
Table 145: 30-Year Cost-Effectiveness Summary Per Dwelling Unit – New Construction/Additions - HPWH-Balance-Valve-Temp-120.....	160
Table 146: 30-Year Cost-Effectiveness Summary Per Dwelling Unit – Alterations - HPWH-Balance-Valve-Temp-120	160
Table 147: 30-Year Cost-Effectiveness Summary Per Dwelling Unit – New Construction/Additions - Gas-Balance-Valve-Temp-120.....	161
Table 148: 30-Year Cost-Effectiveness Summary Per Dwelling Unit – Alterations - Gas-Balance-Valve-Temp-120.....	161
Table 149: Statewide Energy and Energy Cost Impacts – New Construction and Additions – Balance-Valve-Temp-120.....	163
Table 150: Statewide Energy and Energy Cost Impacts – Alterations – Balance-Valve-Temp-120.....	164
Table 151: Statewide Energy and Energy Cost Impacts – New Construction, Additions, and Alterations	164
Table 152: Annual Statewide GHG Emissions Impacts - Balance-Valve-Temp-120...	165
Table 153: Annual Statewide Impacts on Material Use – Thermostatic Balancing Valves	166
Table 154: Designer Interview Results.....	179
Table 155: California Construction Industry, Establishments, Employment, and Payroll in 2022 (Estimated).....	181
Table 156: Specific Subsectors of the California Residential Building Industry by Subsector in 2022 (Estimated).....	182
Table 157: California Building Designer and Energy Consultant Sectors in 2022 (Estimated).....	183
Table 158: California Housing Characteristics in 2021 ^a	184
Table 159: Distribution of California Housing by Vintage in 2021 (Estimated)	184

Table 160: Owner- and Renter-Occupied Housing Units in California by Income in 2021 (Estimated).....	185
Table 161: Employment in California State and Government Agencies with Building Inspectors in 2022 (Estimated).....	187
Table 162: Estimated Impact that Adoption of the Proposed Measure would have on the California Residential Construction	189
Table 163: Estimated Impact that Adoption of the Proposed Measure would have on the California Building Designers and Energy Consultants Sectors	189
Table 164: Estimated Impact that Adoption of the Proposed Measure would have on California Building Inspectors.....	190
Table 165: Net Domestic Private Investment and Corporate Profits, U.S.	191
Table 166: MMV Assumptions	194
Table 167: Prototype Buildings Used for Energy, Demand, Cost, and Environmental Impacts Analysis	196
Table 168: Annual Electricity Savings (kWh) Per Dwelling Unit by Climate Zone (CZ), Prescriptive HPWH - Master Mixing Valve	199
Table 169: Annual Peak Demand Reduction (kW) Per Dwelling Unit by Climate Zone (CZ), Prescriptive HPWH - Master Mixing Valve	199
Table 170: Annual Source Energy Savings (kBtu) Per Dwelling Unit by Climate Zone (CZ), Prescriptive HPWH - Master Mixing Valve	199
Table 171: Annual LSC Savings (2026 PV\$) Per Dwelling Unit by Climate Zone (CZ), Prescriptive HPWH - Master Mixing Valve	199
Table 172: Annual Natural Gas Savings (kBtu) Per Dwelling Unit by Climate Zone (CZ), Prescriptive Gas - Master Mixing Valve.....	200
Table 173: Annual Source Energy Savings (kBtu) Per Dwelling Unit by Climate Zone (CZ), Prescriptive Gas - Master Mixing Valve	200
Table 174: Annual LSC Savings (2026 PV\$) Per Dwelling Unit by Climate Zone (CZ), Prescriptive Gas - Master Mixing Valve.....	200
Table 175: 2026 PV 30-year LSC Savings – Per Dwelling Unit – New Construction and Additions – LowRiseGarden - Prescriptive HPWH - Master Mixing Valve.....	202
Table 176: 2026 PV 30-year LSC Savings – Per Dwelling Unit – New Construction and Additions – LoadedCorridor - Prescriptive HPWH - Master Mixing Valve.....	202
Table 177: 2026 PV 30-year LSC Savings – Per Dwelling Unit – New Construction and Additions – MidRiseMixedUsed - Prescriptive HPWH - Master Mixing Valve.....	203
Table 178: 2026 PV 30-year LSC Savings – Per Dwelling Unit – New Construction and Additions – HighRiseMixedUsed - Prescriptive HPWH - Master Mixing Valve	203

Table 179: 2026 PV 30-year LSC Savings – Per Dwelling Unit – New Construction and Additions – LowRiseGarden - Prescriptive Gas - Master Mixing Valve	204
Table 180: 2026 PV 30-year LSC Savings – Per Dwelling Unit – New Construction and Additions – LoadedCorridor - Prescriptive Gas - Master Mixing Valve	204
Table 181: 2026 PV 30-year LSC Savings – Per Dwelling Unit – New Construction and Additions – MidRiseMixedUse - Prescriptive Gas - Master Mixing Valve	205
Table 182: 2026 PV 30-year LSC Savings – Per Dwelling Unit – New Construction and Additions – HighRiseMixedUse - Prescriptive Gas - Master Mixing Valve	205
Table 183: Total Component Count and Type (Proposed Mechanical MMV, not fully analyzed).....	207
Table 184: Total Component Count and Type (Proposed Digital MMV, fully analyzed)	207
Table 185: MMV Material and Labor Costs for Base Case (CZ Average)	208
Table 186: MMV Mechanical High- Low Valve Material and Labor Costs for Proposed Case (CZ Average) (Not used for full analysis)	208
Table 187: MMV Digital Valve Material and Labor Costs for Proposed Case (CZ Average).....	208
Table 188: Incremental Costs for Base Case vs Proposed Case – Prescriptive HPWH - Master Mixing Valve and Gas – Master Mixing Valve	208
Table 189: Digital or Mechanical MMV 2026 PV\$ Incremental Maintenance Costs Over the Buildings Analysis Period (30 Years)	210
Table 190: Replacement Material and Labor Costs for Base Case.....	210
Table 191: Replacement Material and Labor Costs for Proposed Case	210
Table 192: Incremental Replacement Costs for Base Case vs Proposed Case.....	210
Table 193: 30-Year Cost-Effectiveness Summary Per Dwelling Units – New Construction/Additions – Prescriptive HPWH - Master Mixing Valve	212
Table 194: 30-Year Cost-Effectiveness Summary Per Dwelling Units – New Construction/Additions – Prescriptive Gas - Master Mixing Valve	212
Table 195: Statewide Energy and Energy Cost Impacts – New Construction and Additions – Master Mixing Valve	214
Table 196: Annual Statewide GHG Emissions Impacts - Master Mixing Valve	215
Table 197: Annual Statewide Impacts on Material Use – Master Mixing Valves	215
Table 198: California Construction Industry, Establishments, Employment, and Payroll in 2022 (Estimated)	242
Table 199: Specific Subsectors of the California Residential Building Industry by Subsector in 2022 (Estimated)	243

Table 200: California Building Designer and Energy Consultant Sectors in 2022 (Estimated).....	244
Table 201: California Housing Characteristics in 2021 ^a	245
Table 202: Distribution of California Housing by Vintage in 2021 (Estimated)	246
Table 203: Owner- and Renter-Occupied Housing Units in California by Income in 2021 (Estimated).....	246
Table 204: Employment in California State and Government Agencies with Building Inspectors in 2022 (Estimated).....	248
Table 205: Estimated Impact that Adoption of the Proposed Measure would have on California Building Inspectors	249
Table 206: Net Domestic Private Investment and Corporate Profits, U.S.	251
Table 207: Prototype Buildings Used for Energy, Demand, Cost, and Environmental Impacts Analysis	255
Table 208: Central HPWH Configuration Characteristics	257
Table 209: Modifications Made to Standard Design in LowRiseGarden Prototype to Simulate Proposed Code Change – All Climate Zones	258
Table 210: Modifications Made to Standard Design in LoadedCorridor Prototype to Simulate Proposed Code Change – All Climate Zones	259
Table 211: Modifications Made to Standard Design in MidRiseMixedUse Prototype to Simulate Proposed Code Change – All Climate Zones	260
Table 212: Modifications Made to Standard Design in HighRiseMixedUse Prototype to Simulate Proposed Code Change – All Climate Zones	261
Table 213: Annual Electricity Savings (kWh) Per Dwelling Unit by Climate Zone (CZ) - Central – HPWH_SPST	264
Table 214: Annual Peak Demand Reduction (kW) Per Dwelling Unit by Climate Zone (CZ) - Central - HPWH_SPST.....	264
Table 215: Annual Natural Gas Savings (kBtu) Per Dwelling Unit by Climate Zone (CZ) - Central - HPWH_SPST	264
Table 216: Annual Source Energy Savings (kBtu) Per Dwelling Unit by Climate Zone (CZ) - Central - HPWH_SPST.....	264
Table 217: 30-year LSC Savings Cost Savings (2026 PV\$) Per Dwelling Unit by Climate Zone (CZ) - Central - HPWH_SPST.....	264
Table 218: Annual Electricity Savings (kWh) Per Dwelling Unit - Central - HPWH_SPRetP	266
Table 219: Annual Peak Demand Reduction (kW) Per Dwelling Unit - Central - HPWH_SPRetP	266

Table 220: Annual Natural Gas Savings (kBtu) Per Dwelling Unit - Central - HPWH_SPRetP	266
Table 221: Annual Source Energy Savings (kBtu) Per Dwelling Unit - Central - HPWH_SPRetP	266
Table 222: 30-year LSC Savings Cost Savings (2026 PV\$) Per Dwelling Unit - Central - HPWH_SPRetP	266
Table 223: Annual Electricity Savings (kWh) Per Dwelling Unit - Central - HPWH_MPRetP	268
Table 224: Annual Peak Demand Reduction (kW) Per Dwelling Unit - Central - HPWH_MPRetP	268
Table 225: Annual Natural Gas Savings (kBtu) Per Dwelling Unit - Central - HPWH_MPRetP	268
Table 226: Annual Source Energy Savings (kBtu) Per Dwelling Unit - Central - HPWH_MPRetP	268
Table 227: 30-year LSC Savings Cost Savings (2026 PV\$) Per Dwelling Unit - Central - HPWH_MPRetP	268
Table 228: Annual Electricity Savings (kWh) Per Dwelling Unit - Central - HPWH_SPwMPTM	270
Table 229: Annual Peak Demand Reduction (kW) Per Dwelling Unit - Central - HPWH_SPwMPTM	270
Table 230: Annual Natural Gas Savings (kBtu) Per Dwelling Unit - Central - HPWH_SPwMPTM	270
Table 231: Annual Source Energy Savings (kBtu) Per Dwelling Unit - Central - HPWH_SPwMPTM	270
Table 232: 30-year LSC Savings (2026 PV\$) Per Dwelling Unit - Central - HPWH_SPwMPTM	270
Table 233: 2026 PV 30-year LSC Savings – New Construction and Additions – Central HPWH - HPWH_SPST – LowRiseGarden	274
Table 234: 2026 Present Value LSC Savings Per Dwelling Unit Over 30-Year Period of Analysis – New Construction & Additions – Central HPWH - HPWH_SPST – LoadedCorridor	274
Table 235: 2026 Present Value LSC Savings Per Dwelling Unit Over 30-Year Period of Analysis – New Construction & Additions – Central HPWH - HPWH_SPST – MidRiseMixedUse	275
Table 236: 2026 Present Value LSC Savings Per Dwelling Unit Over 30-Year Period of Analysis – New Construction & Additions – Central HPWH - HPWH_SPST – HighRiseMixedUse	275

Table 237: 2026 Present Value LSC Savings Per Dwelling Unit Over 30-Year Period of Analysis – New Construction & Additions – Central HPWH - HPWH_MPRetP – LowRiseGarden	276
Table 238: 2026 Present Value LSC Savings Per Dwelling Unit Over 30-Year Period of Analysis – New Construction & Additions – Central HPWH - HPWH_MPRetP – LoadedCorridor	276
Table 239: 2026 Present Value LSC Savings Per Dwelling Unit Over 30-Year Period of Analysis – New Construction & Additions – Central HPWH - HPWH_MPRetP – MidRiseMixedUse	277
Table 240: 2026 Present Value LSC Savings Per Dwelling Unit Over 30-Year Period of Analysis – New Construction & Additions – Central HPWH - HPWH_MPRetP – HighRiseMixedUse.....	277
Table 241: 2026 Present Value LSC Savings Per Dwelling Unit Over 30-Year Period of Analysis – New Construction & Additions – Central HPWH - HPWH_SPRetP – LowRiseGarden	278
Table 242: 2026 Present Value LSC Savings Per Dwelling Unit Over 30-Year Period of Analysis – New Construction & Additions – Central HPWH - HPWH_SPRetP – LoadedCorridor	278
Table 243: 2026 Present Value LSC Savings Per Dwelling Unit Over 30-Year Period of Analysis – New Construction & Additions – Central HPWH - HPWH_SPRetP – MidRiseMixedUse	279
Table 244: 2026 Present Value LSC Savings Per Dwelling Unit Over 30-Year Period of Analysis – New Construction & Additions – Central HPWH - HPWH_SPRetP – HighRiseMixedUse.....	279
Table 245: 2026 Present Value LSC Savings Per Dwelling Unit Over 30-Year Period of Analysis – New Construction & Additions – Central HPWH - HPWH_SPwMPTM – MidRiseMixedUse	280
Table 246: 2026 Present Value LSC Savings Per Dwelling Unit Over 30-Year Period of Analysis – New Construction & Additions – Central HPWH - HPWH_SPwMPTM – HighRiseMixedUse.....	280
Table 247: Average 2026 PV 30-year LSC Savings – New Construction and Additions – Central HPWH – HPWH_SPST – All Prototypes	281
Table 248: Average 2026 PV 30-year LSC Savings – New Construction and Additions – Central HPWH – HPWH_SPRetP – All Prototypes	281
Table 249: Average 2026 PV 30-year LSC Savings – New Construction and Additions – Central HPWH – HPWH_MPRetP – All Prototypes.....	282
Table 250: Average 2026 PV 30-year LSC Savings – New Construction and Additions – Central HPWH – HPWH_SPwMPTM – All Prototypes	282

Table 251: Installed Cost for Baseline and Proposed Central HPWH Designs for LowRiseGarden	284
Table 252: Installed Cost for Baseline and Proposed Central HPWH Designs for LoadedCorridor	284
Table 253: Installed Cost for Baseline and Proposed Central HPWH Designs for MidRiseMixedUse	284
Table 254: Installed Cost for Baseline and Proposed Central HPWH Designs for HighRiseMixedUse.....	284
Table 255: Replacement and Maintenance Nominal Cost for Baseline and Proposed Single-Pass Central DWH Designs for LowRiseGarden	285
Table 256: Replacement and Maintenance Nominal Cost for Baseline and Proposed Single-Pass Central DWH Designs for LoadedCorridor	285
Table 257: Replacement and Maintenance Nominal Cost for Baseline and Proposed Single-Pass Central DWH Designs for MidRiseMixedUse	286
Table 258: Replacement and Maintenance Nominal Cost for Baseline and Proposed Single-Pass Central DWH Designs for HighRiseMixedUse.....	286
Table 259: 30-Year Cost-Effectiveness Summary Per Dwelling Unit - New Construction & Additions - HPWH_SPST	287
Table 260: 30-Year Cost-Effectiveness Summary Per Dwelling Unit - New Construction & Additions - HPWH_SPRetP	287
Table 261: 30-Year Cost-Effectiveness Summary Per Dwelling Unit - New Construction & Additions - HPWH_MPRetP	288
Table 262: 30-Year Cost-Effectiveness Summary Per Dwelling Unit - New Construction & Additions - HPWH_SPwMPTM	288
Table 263: California Construction Industry, Establishments, Employment, and Payroll in 2022 (Estimated)	304
Table 264: Specific Subsectors of the California Residential Building Industry by Subsector in 2022 (Estimated)	305
Table 265: California Building Designer and Energy Consultant Sectors in 2022 (Estimated).....	306
Table 266: California Housing Characteristics in 2021 ^a	307
Table 267: Distribution of California Housing by Vintage in 2021 (Estimated)	308
Table 268: Owner- and Renter-Occupied Housing Units in California by Income in 2021 (Estimated).....	308
Table 269: Employment in California State and Government Agencies with Building Inspectors in 2022 (Estimated).....	310

Table 270: Estimated Impact that Adoption of the Proposed Measure would have on the California Residential Construction Sector	312
Table 271: Estimated Impact that Adoption of the Proposed Measure would have on the California Residential Remodel Sector.....	312
Table 272: Net Domestic Private Investment and Corporate Profits, U.S.	314
Table 273: Prototype Buildings Used for Energy, Demand, Cost, and Environmental Impacts Analysis	317
Table 274: Modifications Made to the Prototype to Simulate the Least Cost-Effective Scenario (All Climate Zones).....	319
Table 275: Annual Electricity Savings (kWh) Per Residential Unit by Climate Zone (CZ) – Individual HPWH Ventilation – Exterior Closets	322
Table 276: Annual Peak Demand Reduction (kW) Per Residential Unit by Climate Zone (CZ) – Individual HPWH Ventilation – Exterior Closets	322
Table 277: Annual Natural Gas Savings (kBtu) Per Residential Unit by Climate Zone (CZ) – Individual HPWH Ventilation – Exterior Closets	322
Table 278: Annual Source Energy Savings (kBtu) Per Residential Unit by Climate Zone (CZ) – Individual HPWH Ventilation – Exterior Closets	323
Table 279: 30-Year LSC Savings Cost Savings (2026 PV\$) Per Residential Unit by Climate Zone (CZ) – Individual HPWH Ventilation – Exterior Closets.....	323
Table 280: Annual Electricity Savings (kWh) Per Residential Unit by Climate Zone (CZ) – Individual HPWH Ventilation – Interior Closets	323
Table 281: Annual Peak Demand Reduction (kW) Per Residential Unit – Individual HPWH Ventilation – Interior Closets.....	324
Table 282: Annual Natural Gas Savings (kBtu) Per Residential Unit by Climate Zone (CZ) – Individual HPWH Ventilation – Interior Closets	324
Table 283: Annual Source Energy Savings (kBtu) Per Residential Unit by Climate Zone (CZ) – Individual HPWH Ventilation – Interior Closets	324
Table 284: 30-year LSC Savings Cost Savings (2026 PV\$) Per Residential Unit by Climate Zone (CZ) – Individual HPWH Ventilation – Interior Closets.....	325
Table 285: 2026 PV 30-year LSC Savings – Per Dwelling Unit – New Construction and Additions – HighRiseMixedUse – Exterior Closets.....	327
Table 286: 2026 PV 30-year LSC Savings – Per Dwelling Unit – Alterations – HighRiseMixedUse – Exterior Closets.....	327
Table 287: 2026 PV 30-year LSC Savings – Per Dwelling Unit – New Construction and Additions – LoadedCorridor – Exterior Closets	328
Table 288: 2026 PV 30-year LSC Savings – Per Dwelling Unit – Alterations – LoadedCorridor – Exterior Closets	328

Table 289: 2026 PV 30-year LSC Savings – Per Dwelling Unit – New Construction and Additions – LowRiseGarden – Exterior Closets.....	329
Table 290: 2026 PV 30-year LSC Savings – Per Dwelling Unit – Alterations – LowRiseGarden – Exterior Closets	329
Table 291: 2026 PV 30-year LSC Savings – Per Dwelling Unit – New Construction and Additions – MidRiseMixedUse – Exterior Closets	330
Table 292: 2026 PV 30-year LSC Savings – Per Dwelling Unit – Alterations – MidRiseMixedUse – Exterior Closets	330
Table 293: 2026 PV 30-year LSC Savings – Per Dwelling Unit – New Construction and Additions – SF500 – Exterior Closets.....	331
Table 294: 2026 PV 30-year LSC Savings – Per Dwelling Unit – Alterations – SF500 – Exterior Closets.....	331
Table 295: 2026 PV 30-year LSC Savings – Per Dwelling Unit – New Construction and Additions – SF2100 – Exterior Closets.....	332
Table 296: 2026 PV 30-year LSC Savings – Per Dwelling Unit – Alterations – SF2100 – Exterior Closets.....	332
Table 297: 2026 PV 30-year LSC Savings – Per Dwelling Unit – New Construction and Additions – SF2700 – Exterior Closets.....	333
Table 298: 2026 PV 30-year LSC Savings – Per Dwelling Unit – Alterations – SF2700 – Exterior Closets.....	333
Table 299: Average 2026 PV 30-year LSC Savings – Per Dwelling Unit – New Construction and Additions – All Prototypes – Exterior Closets	334
Table 300: Average 2026 PV 30-year LSC Savings – Per Dwelling Unit – Alterations – All Prototypes – Exterior Closets.....	334
Table 301: 2026 PV 30-year LSC Savings – Per Dwelling Unit – New Construction and Additions – HighRiseMixedUse – Interior Closets	335
Table 302: 2026 PV 30-year LSC Savings – Per Dwelling Unit – Alterations – HighRiseMixedUse – Interior Closets.....	335
Table 303: 2026 PV 30-year LSC Savings – Per Dwelling Unit – New Construction and Additions – LoadedCorridor – Interior Closets.....	336
Table 304: 2026 PV 30-year LSC Savings – Per Dwelling Unit – Alterations – LoadedCorridor – Interior Closets	336
Table 305: 2026 PV 30-year LSC Savings – Per Dwelling Unit – New Construction and Additions – LowRiseGarden – Interior Closets.....	337
Table 306: 2026 PV 30-year LSC Savings – Per Dwelling Unit – Alterations – LowRiseGarden – Interior Closets	337

Table 307: 2026 PV 30-year LSC Savings – Per Dwelling Unit – New Construction and Additions – MidRiseMixedUse – Interior Closets.....	338
Table 308: 2026 PV 30-year LSC Savings – Per Dwelling Unit – Alterations – MidRiseMixedUse – Interior Closets	338
Table 309: 2026 PV 30-year LSC Savings – Per Dwelling Unit – New Construction and Additions – SF500 – Interior Closets.....	339
Table 310: 2026 PV 30-year LSC Savings – Per Dwelling Unit – Alterations – SF500 – Interior Closets.....	339
Table 311: 2026 PV 30-year LSC Savings – Per Dwelling Unit – New Construction and Additions – SF2100 – Interior Closets.....	340
Table 312: 2026 PV 30-year LSC Savings – Per Dwelling Unit – Alterations – SF2100 – Interior Closets.....	340
Table 313: 2026 PV 30-year LSC Savings – Per Dwelling Unit – New Construction and Additions – SF2700 – Interior Closets.....	341
Table 314: 2026 PV 30-year LSC Savings – Per Dwelling Unit – Alterations – SF2700 – Interior Closets.....	341
Table 315: Average 2026 PV 30-year LSC Savings – Per Dwelling Unit – New Construction and Additions – All Prototypes – Interior Closets.....	342
Table 316: Average 2026 PV 30-year LSC Savings – Per Dwelling Unit – Alterations – All Prototypes – Interior Closets	342
Table 317. Summary of Incremental First Costs by Ventilation Method.....	345
Table 318: 30-Year Cost-Effectiveness Summary Per Dwelling Unit – New Construction/Additions – Exterior	347
Table 319: 30-Year Cost-Effectiveness Summary Per Dwelling Unit – Alterations – Exterior.....	347
Table 320: 30-Year Cost-Effectiveness Summary Per Dwelling Unit – New Construction/Additions – Interior	348
Table 321: 30-Year Cost-Effectiveness Summary Per Dwelling Unit – Alterations – Interior.....	348
Table 322: Statewide Energy and Energy Cost Impacts – New Construction and Additions	350
Table 323: Statewide Energy and Energy Cost Impacts – Alterations	351
Table 324: Statewide Energy and Energy Cost Impacts – New Construction, Additions, and Alterations	351
Table 325: Annual Statewide GHG Emissions Impacts.....	352
Table 326: Annual Statewide Impacts on Material Use – Individual HPWH Ventilation	353

Table 327: California Construction Industry, Establishments, Employment, and Payroll in 2022 (Estimated)	368
Table 328: Specific Subsectors of the California Residential Building Industry by Subsector in 2022 (Estimated)	369
Table 329: California Building Designer and Energy Consultant Sectors in 2022 (Estimated).....	370
Table 330: California Housing Characteristics in 2021 ^a	371
Table 331: Distribution of California Housing by Vintage in 2021 (Estimated)	372
Table 332: Owner- and Renter-Occupied Housing Units in California by Income in 2021 (Estimated).....	372
Table 333: Employment in California State and Government Agencies with Building Inspectors in 2022 (Estimated).....	374
Table 334: Estimated Impact that Adoption of the Proposed Measure would have on the California Residential Sector	376
Table 335: Estimated Impact that Adoption of the Proposed Measure would have on the California Building Designers and Energy Consultants Sectors	376
Table 336: Estimated Impact that Adoption of the Proposed Measure would have on California Building Inspectors	376
Table 337: Net Domestic Private Investment and Corporate Profits, U.S.	378
Table 338: Incremental First and Incremental Retrofit Costs Per Dwelling Unit	383
Table 339: Water Heating Closet Augmentation and Door Ventilation Costs Per Dwelling Unit	385
Table 340: Annual Statewide Impacts on Material Use – Individual DHW Electric Ready	386
Table 341: California Construction Industry, Establishments, Employment, and Payroll in 2022 (Estimated)	403
Table 342: Specific Subsectors of the California Residential Building Industry by Subsector in 2022 (Estimated)	404
Table 343: California Building Designer and Energy Consultant Sectors in 2022 (Estimated).....	406
Table 344: California Housing Characteristics in 2021 ^a	407
Table 345: Distribution of California Housing by Vintage in 2021 (Estimated)	407
Table 346: Owner- and Renter-Occupied Housing Units in California by Income in 2021 (Estimated).....	408
Table 347: Employment in California State and Government Agencies with Building Inspectors in 2022 (Estimated).....	409

Table 348: Estimated Impact that Adoption of the Proposed Measure would have on the California Residential Construction Sector	411
Table 349: Estimated Impact that Adoption of the Proposed Measure would have on the California Building Designers and Energy Consultants Sectors	411
Table 350: Estimated Impact that Adoption of the Proposed Measure would have on California Building Inspectors	411
Table 351: Net Domestic Private Investment and Corporate Profits, U.S.	413
Table 352: Incremental Cost Summary for Electric Ready vs. Non - Electric Ready Cases – Low-Rise Garden Style Standard Recovery System CZ 09	419
Table 353: Incremental Cost Summary for Electric Ready vs. Non - Electric Ready Cases – Low-Rise Loaded Corridor Standard Recovery System CZ 09	419
Table 354: Incremental Cost Summary for Electric Ready vs. Non - Electric Ready Cases – Mid-Rise Mixed Use Standard Recovery System CZ 09	420
Table 355: Incremental Cost Summary for Electric Ready vs. Non - Electric Ready Cases – High-Rise Mixed Use Standard Recovery System CZ 09	420
Table 356: Cost-Effectiveness Summary Per Dwelling Unit Standard Recovery System Design Averaged by Climate Zone	422
Table 357: Cost-Effectiveness Summary Per Dwelling Unit High Recovery System Design Averaged Climate Zone	422
Table 358: Cost-Effectiveness Summary Per Dwelling Unit and Climate Zone: Low-Rise Garden Style Standard-Recovery HPWH.....	423
Table 359: Cost-Effectiveness Summary Per Dwelling Unit and Climate Zone: Low-Rise Loaded Corridor Standard-Recovery HPWH.....	424
Table 360: Cost-Effectiveness Summary Per Dwelling Unit and Climate Zone: Low-Rise Loaded Corridor High-Recovery HPWH.....	424
Table 361: Cost-Effectiveness Summary Per Dwelling Unit and Climate Zone: Mid-Rise Standard-Recovery HPWH	425
Table 362: Cost-Effectiveness Summary Per Dwelling Unit and Climate Zone: Mid-Rise High-Recovery HPWH.....	425
Table 363: Cost-Effectiveness Summary Per Dwelling Unit and Climate Zone: High-Rise Standard-Recovery HPWH	426
Table 364: Cost-Effectiveness Summary Per Dwelling Unit and Climate Zone: High-Rise High-Recovery HPWH.....	426
Table 365: Annual Statewide Impacts on Material Use – Central DHW Electric Ready	427
Table 366: Multifamily Building Types and Associated Prototype Weighting	496
Table 367: Multifamily Building Types and Associated DWH Fuel	497

Table 368: Multifamily Building Types DHW Distribution System Types	497
Table 369: Appendix M Statewide Impacts	497
Table 370: Pipe Insulation Statewide Impacts.....	498
Table 371: Require Automatic Balancing Valves (ABV) Statewide Impacts.....	498
Table 372: Master Mixing Valve (MMV) Impacts.....	498
Table 373: Central HPWH Statewide Impacts-Building Prototype for Energy Modeling	499
Table 374: Estimated New Construction and Existing Building Stock for Multifamily Buildings by Climate Zone – Central HPWH	499
Table 375: Individual Electric Ready Statewide Impacts	500
Table 376: Central Electric Ready Statewide Impacts.....	500
Table 377: Ventilation Statewide Impacts for New Constructions and Additions.....	501
Table 378: Ventilation Statewide Impacts for Alterations	501
Table 379: Estimated New Construction and Existing Building Stock for Single Family Buildings by Climate Zone – Individual HPWH Ventilation-Exterior Closet	502
Table 380: Estimated New Construction and Existing Building Stock for Multifamily Buildings by Climate Zone – Individual HPWH Ventilation-Exterior Closet	503
Table 381: Estimated New Construction and Existing Building Stock for Single Family Buildings by Climate Zone – Individual HPWH Ventilation-Interior Closet.....	504
Table 382: Estimated New Construction and Existing Building Stock for Multifamily Buildings by Climate Zone – Individual HPWH Ventilation-Interior Closet.....	505
Table 383: Estimated Annual Water and Energy Savings Per Dwelling Unit	507
Table 384: Estimated New Multi-Family Building Construction	507
Table 385: Additional User Inputs Relevant to the Water Heating System.....	511
Table 386: Percentage of Nonresidential Floorspace Impacted by Proposed Measure, by Climate Zone	512
Table 387: First Year Statewide Embodied Carbon Emissions Impacts.....	519
Table 388: Roles of Market Actors in CPC Appendix M Pipe Sizing	521
Table 389: Roles of Market Actors in Pipe Insulation Enhancement.....	523
Table 390: Roles of Market Actors in Require Balancing Valves	525
Table 391: Roles of Market Actors in MMVs	526
Table 392: Roles of Market Actors in Central HPWH Requirements.....	527
Table 393: Roles of Market Actors in Individual HPWH Ventilation.....	529
Table 394: Roles of Market Actors in Individual DHW Electric Ready.....	531
Table 395: Roles of Market Actors in Central HPWH Electric Ready	533

Table 396: Utility-Sponsored Stakeholder Meetings	537
Table 397: Engaged Stakeholders	538
Table 398: Statewide CASE Team Internal Subject Matter Experts.....	539
Table 399: Nominal 30-year LSC Savings – Per Dwelling Unit – New Construction – HPWH - AppM – LowRiseGarden	543
Table 400: Nominal 30-year LSC Savings – Per Dwelling Unit – New Construction – HPWH - AppM – LoadedCorridor	543
Table 401: Nominal 30-year LSC Savings – Per Dwelling Unit – New Construction – HPWH - AppM – MidRiseMixedUse	544
Table 402: Nominal LSC Cost Savings Over 30-Year Period of Analysis – Per Dwelling Unit – New Construction – HPWH - AppM – HighRiseMixedUse	544
Table 403: Nominal 30-year LSC Savings – Per Dwelling Unit – New Construction – Gas - AppM – LowRiseGarden	545
Table 404: Nominal 30-year LSC Savings – Per Dwelling Unit – New Construction – Gas - AppM – LoadedCorridor	545
Table 405: Nominal 30-year LSC Savings – Per Dwelling Unit – New Construction – Gas - AppM – MidRiseMixedUse	546
Table 406: Nominal 30-year LSC Savings – Per Dwelling Unit – New Construction – Gas - AppM – HighRiseMixedUse.....	546
Table 407: Nominal 30-year LSC Savings – Per Dwelling Unit – New Construction – HPWH - Insulation – LowRiseGarden	547
Table 408: Nominal 30-year LSC Savings – Per Dwelling Unit – New Construction – HPWH - Insulation – LoadedCorridor	547
Table 409: Nominal 30-year LSC Savings – Per Dwelling Unit – New Construction – HPWH - Insulation – MidRiseMixedUse	548
Table 410: Nominal 30-year LSC Savings – Per Dwelling Unit – New Construction – HPWH - Insulation – HighRiseMixedUse	548
Table 411: Nominal 30-year LSC Savings – Per Dwelling Unit – New Construction – Gas - Insulation – LowRiseGarden	549
Table 412: Nominal 30-year LSC Savings – Per Dwelling Unit – New Construction – Gas - Insulation – LoadedCorridor	549
Table 413: Nominal 30-year LSC Savings – Per Dwelling Unit – New Construction – Gas - Insulation – MidRiseMixedUse	550
Table 414: Nominal 30-year LSC Savings – Per Dwelling Unit – New Construction – Gas - Insulation – HighRiseMixedUse.....	550
Table 415: Nominal 30-year LSC Savings – Per Dwelling Unit – New Construction & Additions – HPWH-Balance-Valve-Temp-120 – LowRiseGarden	551

Table 416: Nominal 30-year LSC Savings – Per Dwelling Unit – New Construction & Additions – HPWH-Balance-Valve-Temp-120 – LoadedCorridor	551
Table 417: Nominal 30-year LSC Savings – Per Dwelling Unit – New Construction & Additions – Gas - Balance-Valve-Temp-120 – LowRiseGarden.....	552
Table 418: Nominal 30-year LSC Savings – Per Dwelling Unit – New Construction & Additions – Gas - Balance-Valve-Temp-120 – LoadedCorridor	552
Table 419: Nominal 30-year LSC Savings – Per Dwelling Unit – Alterations – HPWH - Balance-Valve-Temp-120 – LowRiseGarden	553
Table 420: Nominal 30-year LSC Savings – Per Dwelling Unit – Alterations – HPWH - Balance-Valve-Temp-120 – LoadedCorridor.....	553
Table 421: Nominal 30-year LSC Savings – Per Dwelling Unit – Alterations – Gas - Balance-Valve-Temp-120 – LowRiseGarden	554
Table 422: Nominal 30-year LSC Savings – Per Dwelling Unit – Alterations – Gas - Balance-Valve-Temp-120 – LoadedCorridor.....	554
Table 423: Nominal 30-year LSC Savings – Per Dwelling Unit – New Construction – Mandatory HPWH - Master Mixing Valve – LowRiseGarden	555
Table 424: Nominal 30-year LSC Savings – Per Dwelling Unit – New Construction – Mandatory HPWH - Master Mixing Valve – LoadedCorridor	555
Table 425: Nominal 30-year LSC Savings – Per Dwelling Unit – New Construction – Mandatory HPWH - Master Mixing Valve – MidRiseMixedUse	556
Table 426: Nominal 30-year LSC Savings – Per Dwelling Unit – New Construction & Additions – Mandatory HPWH - Master Mixing Valve – HighRiseMixedUse	556
Table 427: Nominal 30-year LSC Savings – Per Dwelling Unit – New Construction – Mandatory Gas - Master Mixing Valve – LowRiseGarden.....	557
Table 428: Nominal 30-year LSC Savings – Per Dwelling Unit – New Construction – Mandatory Gas - Master Mixing Valve – LoadedCorridor.....	557
Table 429: Nominal 30-year LSC Savings – Per Dwelling Unit – New Construction – Mandatory Gas - Master Mixing Valve – MidRiseMixedUse.....	558
Table 430: Nominal 30-year LSC Savings – Per Dwelling Unit – New Construction – Mandatory Gas - Master Mixing Valve – HighRiseMixedUse	558
Table 431: Nominal LSC Cost Savings Over 30-Year Period of Analysis – Per Dwelling Unit – New Construction – Compliance HPWH - Master Mixing Valve – LowRiseGarden	559
Table 432: Nominal 30-year LSC Savings – Per Dwelling Unit – New Construction – Compliance HPWH - Master Mixing Valve – LoadedCorridor	559
Table 433: Nominal 30-year LSC Savings – Per Dwelling Unit – New Construction – Compliance HPWH - Master Mixing Valve – MidRiseMixedUse	560

Table 434: Nominal 30-year LSC Savings – Per Dwelling Unit – New Construction – Compliance HPWH - Master Mixing Valve – HighRiseMixedUse.....	560
Table 435: Nominal 30-year LSC Savings – Per Dwelling Unit – New Construction – Compliance Gas - Master Mixing Valve – LowRiseGarden.....	561
Table 436: Nominal 30-year LSC Savings – Per Dwelling Unit – New Construction – Compliance Gas - Master Mixing Valve – LoadedCorridor.....	561
Table 437: Nominal 30-year LSC Savings – Per Dwelling Unit – New Construction – Compliance Gas - Master Mixing Valve – MidRiseMixedUse.....	562
Table 438: Nominal 30-year LSC Savings – Per Dwelling Unit – New Construction – Compliance Gas - Master Mixing Valve – HighRiseMixedUse	562
Table 439: Nominal 30-year LSC Savings – Per Dwelling Unit – New Construction – HPWH - SPST – LowRiseGarden	563
Table 440: Nominal 30-year LSC Savings – Per Dwelling Unit – New Construction – HPWH - SPST – LoadedCorridor	563
Table 441: Nominal 30-year LSC Savings – Per Dwelling Unit – New Construction – HPWH - SPST – MidRiseMixedUse	564
Table 442: Nominal 30-year LSC Savings – Per Dwelling Unit – New Construction – HPWH - SPST – HighRiseMixedUse	564
Table 443: Nominal 30-year LSC Savings – Per Dwelling Unit – New Construction – HPWH-SPRetP – LowRiseGarden.....	565
Table 444: Nominal 30-year LSC Savings – Per Dwelling Unit – New Construction – HPWH-SPRetP – LoadedCorridor	565
Table 445: Nominal 30-year LSC Savings – Per Dwelling Unit – New Construction – HPWH - SPRetP – MidRiseMixedUse.....	566
Table 446: Nominal 30-year LSC Savings – Per Dwelling Unit – New Construction – HPWH - SPRetP – HighRiseMixedUse	566
Table 447: Nominal 30-year LSC Savings – Per Dwelling Unit – New Construction – HPWH - MPRetP – LowRiseGarden	567
Table 448: Nominal 30-year LSC Savings – Per Dwelling Unit – New Construction – HPWH - MPRetP – LoadedCorridor	567
Table 449: Nominal 30-year LSC Savings – Per Dwelling Unit – New Construction – HPWH - MPRetP – MidRiseMixedUse	568
Table 450: Nominal 30-year LSC Savings – Per Dwelling Unit – New Construction – HPWH - MPRetP – HighRiseMixedUse	568
Table 451: Nominal 30-year LSC Savings – Per Dwelling Unit – New Construction – HPWH - SPwMPST – MidRiseMixedUse	569

Table 452: Nominal 30-year LSC Savings – Per Dwelling Unit – New Construction – HPWH - SPwMPST – HighRiseMixedUse	569
Table 453: Nominal 30-year LSC Savings – Per Dwelling Unit – New Construction – Ventilation - Exterior Closet – LowRiseGarden	570
Table 454: Nominal 30-year LSC Savings – Per Dwelling Unit – New Construction – Ventilation - Exterior Closet – LoadedCorridor	570
Table 455: Nominal 30-year LSC Savings – Per Dwelling Unit – New Construction – Ventilation - Exterior Closet – SF500	571
Table 456: Nominal 30-year LSC Savings – Per Dwelling Unit – New Construction – Ventilation - Exterior Closet – SF2100	571
Table 457: Nominal 30-year LSC Savings – Per Dwelling Unit – New Construction – Ventilation - Exterior Closet – SF2700	572
Table 458: Nominal 30-year LSC Savings – Per Dwelling Unit – Alterations – Ventilation - Exterior Closet – LowRiseGarden	572
Table 459: Nominal 30-year LSC Savings – Per Dwelling Unit – Alterations – Ventilation - Exterior Closet – LoadedCorridor	573
Table 460: Nominal 30-year LSC Savings – Per Dwelling Unit – Alterations – Ventilation - Exterior Closet – MidRiseMixedUse	573
Table 461: Nominal 30-year LSC Savings – Per Dwelling Unit – Alterations – Ventilation - Exterior Closet – HighRiseMixedUse	574
Table 462: Nominal 30-year LSC Savings – Per Dwelling Unit – Alterations – Ventilation - Exterior Closet – SF500	574
Table 463: Nominal 30-year LSC Savings – Per Dwelling Unit – Alterations – Ventilation - Exterior Closet – SF2100	575
Table 464: Nominal 30-year LSC Savings – Per Dwelling Unit – Alterations – Ventilation - Exterior Closet – SF2700	575
Table 465: Nominal 30-year LSC Savings – Per Dwelling Unit – New Construction – Ventilation - Interior Closet – LowRiseGarden	576
Table 466: Nominal 30-year LSC Savings – Per Dwelling Unit – New Construction – Ventilation - Interior Closet – LoadedCorridor	576
Table 467: Nominal 30-year LSC Savings – Per Dwelling Unit – New Construction – Ventilation - Interior Closet – LowRiseMixedUse	577
Table 468: Nominal 30-year LSC Savings – Per Dwelling Unit – New Construction – Ventilation - Interior Closet – HighRiseMixedUse	577
Table 469: Nominal 30-year LSC Savings – Per Dwelling Unit – New Construction – Ventilation - Interior Closet – SF500	578

Table 470: Nominal 30-year LSC Savings – Per Dwelling Unit – New Construction – Ventilation - Interior Closet – SF2100.....	578
Table 471: Nominal 30-year LSC Savings – Per Dwelling Unit – New Construction – Ventilation - Interior Closet – SF2700.....	579
Table 472: Nominal 30-year LSC Savings – Per Dwelling Unit – Alterations – Ventilation - Interior Closet – LowRiseGarden	579
Table 473: Nominal 30-year LSC Savings – Per Dwelling Unit – Alterations – Ventilation - Interior Closet – LoadedCorridor	580
Table 474: Nominal 30-year LSC Savings – Per Dwelling Unit – Alterations – Ventilation - Interior Closet – MidRiseMixedUse	580
Table 475: Nominal 30-year LSC Savings – Per Dwelling Unit – Alterations – Ventilation - Interior Closet – HighRiseMixedUse	581
Table 476: Nominal 30-year LSC Savings – Per Dwelling Unit – Alterations – Ventilation - Interior Closet – SF500	581
Table 477: Nominal 30-year LSC Savings – Per Dwelling Unit – Alterations – Ventilation - Interior Closet – SF2100	582
Table 478: Nominal 30-year LSC Savings – Per Dwelling Unit – Alterations – Ventilation - Interior Closet – SF2700	582
Table 479: Heating and Cooling Mode and Average Indoor Temperature by Climate Zone	586
Table 480: Amount of Recirculation Pipes Not Insulated in the Base Case	588
Table 481: Appurtenance Length and Equivalent Pipe Length by Pipe Diameter	592
Table 482: Low-Rise Garden Style Domestic Hot Water Pipe Length by Diameter CPC Appendix A Specifications.....	595
Table 483: Low-Rise Loaded Corridor Domestic Hot Water Pipe Length by Diameter CPC Appendix A Specifications	595
Table 484: Mid-Rise Domestic Hot Water Pipe Length by Diameter CPC Appendix A Specifications	596
Table 485: High-Rise Domestic Hot Water Pipe Length by Diameter CPC Appendix A Specifications	597
Table 486: CPC Appendix A Gas Heating Plant Appurtenance Counts and Straight Pipe Length Appendix A.....	598
Table 487: CPC Appendix A HPWH Plant Appurtenance Counts and Straight Pipe Length CPC Appendix A	599
Table 488: Cost Data Collection Example - Mid-Rise Mixed Use CPC Appendix A Base Case (Gas and HPWH Plant).....	600

Table 489: Cost Data Collection Example Mid-Rise Mixed Use Enhanced Pipe Insulation Base Case (Gas and HPWH Plant)	601
Table 490: Cost Data Collection Example - Mid-Rise Mixed Use Enhanced Pipe Insulation Proposed Case (Gas & HPWH Plant).....	603
Table 491: Low-Rise Garden Style Domestic Hot Water Pipe Length by Diameter CPC Appendix M Specifications	606
Table 492: Low-Rise Loaded Corridor Domestic Hot Water Pipe Length by Diameter CPC Appendix M Specifications.....	607
Table 493: Mid-Rise Domestic Hot Water Pipe Length by Diameter CPC Appendix M Specifications	608
Table 494: High-Rise Domestic Hot Water Pipe Length by Diameter CPC Appendix M Specifications	609
Table 495: Gas Heating Plant Appurtenance Counts and Straight Pipe Length CPC Appendix M	610
Table 496: HPWH Plant Appurtenance Counts and Straight Pipe Length CPC Appendix M	611
Table 497: Cost Data Collection Example Mid-Rise Mixed Use (Gas and HPWH Plant)	612
Table 498: Capacity Requirements for Single-pass primary with Electric Resistance Water Heater	615
Table 499: Primary Heat Pump	616
Table 500: Primary Hot Water Storage Tank	616
Table 501: Primary Electric Resistance Back-Up.....	616
Table 502: Temperature Maintenance Electric Resistance	616
Table 503: Primary Heat Pump	617
Table 504: Primary Hot Water Storage Tank	617
Table 505: Primary Electric Resistance Back-Up.....	617
Table 506: Temperature Maintenance Electric Resistance	617
Table 507: Capacity Requirements for Multi-pass Return to Primary.....	618
Table 508: Primary Heat Pump	619
Table 509: Primary Hot Water Storage Tank	619
Table 510: Primary Electric Resistance Back-Up.....	619
Table 511: Capacity Requirements for Single-pass Primary with Multi-pass in parallel for Temperature Maintenance System design.....	620
Table 512: Primary Heat Pump	621
Table 513: Primary Hot Water Storage Tank	621

Table 514: Primary Electric Resistance Back-Up	621
Table 515: Temperature Maintenance HPWH	621
Table 516: Temperature Maintenance Storage Tank	621
Table 517: Capacity Requirements for Single-pass Return to Primary	622
Table 518: Primary Heat Pump	623
Table 519: Primary Hot Water Storage Tank	623
Table 520: Primary Electric Resistance Back-Up	623
Table 521: Installed Cost Breakdown for Baseline and Proposed Central HPWH Designs for LowRiseGarden	624
Table 522: Installed Cost Breakdown for Baseline and Proposed Central HPWH Designs for LoadedCorridor	625
Table 523: Installed Cost Breakdown for Baseline and Proposed Central HPWH Designs for MidRiseMixedUse	626
Table 524: Installed Cost Breakdown for Baseline and Proposed Central HPWH Designs for HighRiseMixedUse.....	627
Table 525. Summary of Incremental First Costs by Ventilation Method.	635
Table 526: Building Prototypes Basis of Design Specifications.....	642
Table 527: Cost Summary for Electric Ready vs. Non - Electric Ready Cases - Mid-Rise Mixed Use High Recovery System CZ 09 Example Cost at Time of Construction	644
Table 528: Base Case Central Gas Water Heater /System Specifications.....	645
Table 529: Standard Recovery Central Heat Pump Water Heater System Specifications	646
Table 530: High Recovery Central Heat Pump Water Heater System Specifications .	647
Table 531: Studio Dwelling Unit Panel Schedule and Electrical Load Calculations	648
Table 532: Dwelling Unit Electrical Load Totals	649
Table 533: Mid-Rise Mixed Use Central High Recovery Building Electrical Load Calculation (Proposed Electric Water Heating, 88 Dwelling Units).....	650
Table 534: Mid-Rise Mixed Use Central Gas Water Heating Building Electrical Load Calculation (High Recovery, Baseline Gas Water Heating).....	650
Table 535: Raw Cost Data Component Definitions	651
Table 536: Mid-Rise New Construction Base Case Raw Costs	652
Table 537: Mid-Rise New Construction Proposed Raw Costs (Central High Recovery)	653
Table 538: Mid-Rise Retrofit Raw Costs (Central High Recovery)	654
Table 539: Individual Dwelling Unit Water Heating System Specifications.....	663
Table 540: DHW Closet Requirements	663

Table 541: DHW Closet Augmentation and Ventilation Raw Cost Data	664
Table 542: Prototype Buildings Used for Energy, Demand, Cost, and Environmental Impacts Analysis	665
Table 543: Annual Peak Demand Reduction (W) Per Sq. Ft. by Climate Zone (CZ) ..	666
Table 544: Annual Natural Gas Savings (kBtu) Per Sq. Ft. by Climate Zone (CZ).....	666
Table 545: Annual Source Energy Savings (kBtu) Per Sq. Ft. by Climate Zone (CZ) .	667
Table 546: Annual LSC Savings Cost Savings (2026 PV\$) Per Sq. Ft. by Climate Zone (CZ).....	667
Table 547: 2026 PV 30-year LSC Savings – Per Sq. Ft. – OfficeSmall	668
Table 548: 2026 PV 30-year LSC Savings – Per Sq. Ft. – RestaurantSmall	668
Table 549: 30-Year Cost-Effectiveness Summary Per Square Feet – OfficeSmall	669
Table 550: 30-Year Cost-Effectiveness Summary Per Square Feet – RestaurantSmall	669
Table 551: Characteristics of Recirculation Distribution Systems	672
Table 552: HP Heating Plant Lab Test Configurations	678
Table 553: Lab Test Results of HPWH System without MMV	681
Table 554: Lab Test Results of HPWH System with Mechanical MMV	682
Table 555: Lab Test Results of HPWH System with Digital MMV	682
Table 556: Summary of MMV Energy Savings with and without MMV	683
Table 557: System Energy Savings from Mechanical MMV Standard Design	683
Table 558: Low-Rise Loaded Corridor Building Level Electric Ready Planning Impacts (In-unit HPWH/ In-unit Dryer/ In-unit Range).....	685

List of Figures

Figure 1: Comparing UPC Appendix A and M design predictions to actual multifamily building peak flow rates.....	20
Figure 2: Field observation punch list photo showing missing pipe insulation.....	65
Figure 3: Illustration of improper and proper elbow insulation.....	66
Figure 4: DHW distribution types of HPWH systems.....	230
Figure 5: Refrigerant vs. minimal HPWH operating ambient air temperature.....	232
Figure 6: Heat pump heating capacity at ~40°F over capacity at ~70°F ambient air temperature for different refrigerants.....	232
Figure 7: Heating COP at ~40°F ambient air temperature and at ~70°F ambient air temperature for different refrigerants.....	233

Figure 8: Single-pass primary with electric resistance water heater in series for temperature maintenance system (Ref: NEEA, 2022).....	236
Figure 9: Single-pass return to primary (Ref: NEEA, 2022).....	236
Figure 10: Single-pass primary with multi-pass in parallel for temperature maintenance system (Ref: NEEA, 2022).	237
Figure 11: Multi-pass return to primary (Ref: NEEA, 2022).	237
Figure 12: Single-pass vs. multi-pass application.	238
Figure 13: Different refrigerant types.....	238
Figure 14: Whether recirculation system is decoupled or not.	239
Figure 15: Air source HPWHs: refrigerant per system capacity.	240
Figure 16: NEEA commercial HPWH system efficiency tiers.	241
Figure 17: Example of annual HPWH SysCOP - Climate Zone 12.	271
Figure 18: System COP for various HPWH configurations from lab test and real-world projects.....	272
Figure 19: Consumer integrated HPWHs (left to right: Bradford-White, A.O. Smith, and Rheem).	299
Figure 20: HPWH ventilation methods used in reviewed designs.	302
Figure 21: Fully louvered door.....	302
Figure 22: DHW closet door with lower grilles from a small commercial kitchen in Woodland, CA.	344
Figure 23: Ventilation grilles on the door of the closet used in laboratory tests.....	344
Figure 24: Electric ready cases.	381
Figure 25: Electric ready base case vs. proposed case.	416
Figure 26: Low-rise garden style domestic hot water piping schematic with appurtenance locations.	594
Figure 27: Low-rise loaded corridor domestic hot water piping schematic with appurtenance locations.	595
Figure 28: Mid-rise domestic hot water piping schematic with appurtenance locations.	596
Figure 29: High-rise domestic hot water piping schematic with appurtenance locations.	597
Figure 30: Pipe and appurtenance type key.....	605
Figure 31: Low-rise garden style domestic hot water piping schematic with appurtenance locations.	606
Figure 32: Low-rise loaded corridor domestic hot water piping schematic with appurtenance locations.	607

Figure 33: Mid-rise domestic hot water piping schematic with appurtenance locations.	608
Figure 34: High-rise domestic hot water piping schematic with appurtenance locations.	609
Figure 35: Single-pass primary with electric resistance water heater for temperature maintenance system.	615
Figure 36: Multi-pass return to primary.....	618
Figure 37: Single-pass primary with multi-pass in parallel for temperature maintenance system design.	620
Figure 38: Single-pass return to primary.	622
Figure 39: Unducted HPWH efficiency reduction vs unvented room volume.	628
Figure 40: Unducted HPWH efficiency reduction in a small closet vs. net free area of vents connecting the DHW closet to larger interior spaces.	629
Figure 41. Manufacturer ventilation requirements by compressor capacity.....	631
Figure 42. Estimated annual COP for HPWHs in small exterior closets with ventilation grilles based on laboratory test results.	632
Figure 43: Percentage of annual hours for each climate zone when outdoor air temperature is below 40F.....	632
Figure 44: Average NFA for doors in survey by door width.	633
Figure 45: DHW closet door with lower grilles from a small commercial kitchen in Woodland, CA.	634
Figure 46: Ventilation grilles on the door of the closet used in laboratory tests.	634
Figure 47: Examples of louvered closet doors and retrofit grilles installed.	637
Figure 48: Mid and high-rise electrical riser diagram.....	641
Figure 49: Low-rise electrical riser diagram.....	642
Figure 50: Water heating system floor plans by building prototype.	648
Figure 51: Low-rise garden style base case electrical SLD.....	655
Figure 52: Low rise garden style central HPWH electrical SLD.....	656
Figure 53: Low rise loaded corridor base case electrical SLD.....	657
Figure 54: Low-rise loaded corridor central high-recovery HPWH electrical SLD.	658
Figure 55: Mid-rise mixed use base case electrical SLD.....	659
Figure 56: Mid-rise mixed use central high-recovery HPWH electrical SLD.....	660
Figure 57: High-rise mixed use base case electrical SLD.	661
Figure 58: High-rise mixed use central high-recovery HPWH electrical SLD.	662
Figure 59: Schematics of recirculation distribution system for testing.	671

Figure 60: Folded design of test recirculation system. 672
Figure 61: Balancing valve performance at multiple conditions..... 674
Figure 62: Balancing valve performance at select conditions..... 675

Executive Summary

The Codes and Standards Enhancement (CASE) Initiative presents recommendations to support the California Energy Commission’s (the CEC’s) efforts to update the California Energy Code (Title 24, Part 6) to include new requirements or to upgrade existing requirements for various technologies. Three California Investor-Owned Utilities (IOUs)—Pacific Gas and Electric Company, San Diego Gas and Electric, and Southern California Edison—and two Publicly Owned Utilities—Los Angeles Department of Water and Power, and Sacramento Municipal Utility District (herein referred to as the Statewide CASE Team when including the CASE Author) —sponsored this effort. The program goal is to prepare and submit proposals that would result in cost-effective enhancements to improve energy efficiency and energy performance in California buildings. This report and the code change proposals presented herein are a part of the effort to develop technical and cost-effectiveness information for proposed requirements on building energy-efficient design practices and technologies.

The Statewide CASE Team submits code change proposals to the CEC, the state agency that has authority to adopt revisions to Title 24, Part 6. The CEC would evaluate proposals submitted by the Statewide CASE Team and other stakeholders. The CEC may revise or reject proposals. See the CEC’s 2025 Title 24 website for information about the rulemaking schedule and how to participate in the process:

<https://www.energy.ca.gov/programs-and-topics/programs/building-energy-efficiency-standards/2025-building-energy-efficiency>.

The Statewide CASE Team gathered input from stakeholders to inform the proposal and associated analyses and justifications. Stakeholders also provided input on the code compliance and enforcement process. See Appendix F for a summary of stakeholder engagement.

The goal of this CASE Report is to present a cost-effective code change proposal for California Plumbing Code (CPC) Appendix M pipe sizing, pipe insulation enhancement, require balancing valves, require master mixing valves, central heat pump water heater (HPWH) clean-up, individual HPWH ventilation, individual DHW electric ready clean-up, and central DHW electric ready. The report contains pertinent information supporting the code changes.

CPC Appendix M Pipe Sizing

Proposed Code Change

This proposal recommends using pipe sizing methodology based on CPC Appendix M in lieu of the standard practice CPC Appendix A. Specifically, this measure would add a prescriptive requirement in Section 170.2(d) for sizing water pipes according to CPC Appendix M for central DHW systems in multifamily buildings. This measure would apply only to newly constructed multifamily buildings. The proposal would require minor updates to the compliance software. This measure would not add field verification or acceptance tests. Sizing water pipes according to CPC Appendix M is currently a compliance credit in California Building Energy Code Compliance (CBECC) 2022.

As a state agency with jurisdiction over multifamily buildings, the Department of Housing and Community Development (HCD) proposed to adopt Uniform Plumbing Code (UPC) Appendix M into the CPC as part of 2022 Intervening Code Cycle. The California Building Standards Commission approved final adoption of UPC Appendix M on August 1, 2023. Next, UPC Appendix M will be published into CPC on January 1, 2024, and will be available for statewide use on a voluntary basis on July 1, 2024.

Justification

Standard practice pipe sizing is based on CPC Appendix A. CPC Appendix A uses the water supply fixture units approach and is based on estimated demand curve chart, referred to as Hunter's curve, to estimate maximum water demand in each piping section and calculate pipe diameter for that section based on water velocity and pressure drop. Appendix A sizing uses outdated fixture flows and conservative flow diversity in pipes upstream of multiple fixtures. CPC Appendix M contains a performance-based pipe sizing calculation procedure that accounts for California code-required, low-flow fixtures, and it uses a large dataset of flow diversity in real buildings to create a more accurate prediction of peak flow.

CPC Appendix M typically results in smaller diameter cold, reclaimed water and hot water distribution piping, and heating plant piping than standard practice sizing. Smaller diameter piping results in lower project first costs for piping, fittings, appurtenances and pipe insulation, and reduced water and wastewater capacity charges in jurisdictions that charge a fee based on mains meter size. During building operation, the pipe sizing reductions in the hot water distribution system and at the heating plant reduces pipe heat losses leading to lower energy use at the heating plant. The smaller pipe size would reduce health risks and improve water quality due to shorter dwell times as well. It would result in faster hot water delivery times in non-recirculated sections, leading to water savings.

Background Information

CPC Appendix M was added to the UPC in 2018 and includes an alternative pipe sizing procedure. The CPC Appendix M addition was the first major water pipe sizing update in 80 years. The CPC Appendix M sizing methodology is being widely circulated and utilized among designers and is supported by IAPMO’s Water Demand Calculator (WDC). The CPC Appendix M pipe sizing procedure is included in the 2021 UPC and in Appendix C of the 2020 Water Efficiency and Sanitation Standard (WE-Stand).

Outside of California, the following jurisdictions have adopted UPC Appendix M into their plumbing code: Hawaii, Nevada, New Mexico, North Dakota, Oregon, and the City of Seattle and King County, Washington. Wisconsin has approved the WDC as an alternative standard. In California, Appendix M can only be used in Foster City, City of San Jose, City of Oakland, and County of Santa Cruz. These municipalities have adopted Appendix M into their building regulations.

As a code change proposal, Appendix M originated within the Statewide CASE Team in the 2022 Title 24, Part 6 update cycle, and it was added as a compliance credit in CBECC 2022 because of Statewide CASE Team efforts. The 2022 Title 24, Part 6 Statewide CASE Team found that there is interest in using CPC Appendix M for design calculations, but stakeholder conversations and designer interviews show there is limited market adoption.

Scope of Code Change Proposal

Table 1 summarizes the scope of the proposed changes and which sections of standards, Reference Appendices, Alternative Calculation Manual (ACM) Reference Manuals, and compliance documents that would be modified as a result of the proposed change(s).

Table 1: Scope of Code Change Proposal – Appendix M

Type of Requirement	Prescriptive
Applicable Climate Zones	All
Modified Section(s) of Title 24, Part 6	Section 170.2(d)
Modified Title 24, Part 6 Appendices	
Would Compliance Software Be Modified	Yes, 6.11 DHW
Modified Compliance Document(s)	<ul style="list-style-type: none"> • 2022-LMCC-PLB-E: Domestic Water Heating • 2022-NRCC-PLB-E: Domestic Water Heating • 2022-LMCC-PRF-E: Domestic Water Heating • 2022-NRCC-PRF-E: Domestic Water Heating • 2022-LMCI-PLB-E: Domestic Water Heating • 2022-NRCI-PLB-E: Domestic Water Heating

Market Analysis and Regulatory Assessment

The Statewide CASE Team performed a market analysis with the goals of identifying current technology availability, current product availability, and market trends. The Statewide CASE Team considered how the proposed standard may impact the market in general as well as individual market actors. A city senior building inspector from a municipality that allows CPC Appendix M sizing stated anecdotally that only two multifamily projects out of all the projects submitted for plan review since municipal code adoption in 2022 used CPC Appendix M sizing, suggesting a lack of awareness of the municipal code change and familiarity of the methodology. Another inspector from another municipality that permits CPC Appendix M stated that they have not seen any Appendix M pipe sizing in the projects that they have inspected. These municipal codes are only a few years old, and it is likely designers and developers are not aware of the Appendix M option in these specific cities. In addition to conducting personalized outreach, the Statewide CASE Team discussed the current market structure and potential market barriers during a public stakeholder meeting that the Statewide CASE Team held on February 17, 2023.

The Statewide CASE Team determined that CPC Appendix M Pipe Sizing is technically feasible for adoption as a prescriptive measure based on literature review, field monitored flowrate data, adoption into city municipal codes in California, adoption into city and state plumbing codes outside California, interviews with designers, support from a wide range of stakeholders, and other considerations.

This prescriptive measure is not feasible without updates to the CPC in the Appendix M Matrix Adoption Table to show local jurisdiction adoption of CPC Appendix M as an optional sizing method. HCD adoption in March 2023 was a major milestone on the path to final adoption of UPC Appendix M by the California Building Standards Commission, which was completed on August 1, 2023. This would allow builders to utilize the new pipe sizing procedure as a voluntary option in the CPC.

Foster City, City of San Jose, City of Oakland, and County of Santa Cruz may have a compliance process that can provide guidance for the CEC, state agencies, and other jurisdictions on how to best implement this new pipe sizing option.

The Statewide CASE Team would expect a significant impact on the California residential construction sector. Refer to Section 3.2.4 for details.

Cost-Effectiveness

The proposed code change was found to be cost effective for all climate zones where it is proposed to be required. The benefit-to-cost (B/C) ratio over the 30-year period of analysis is >1 for a heat pump water heater as well as a gas water heater for all climate zones. See more details in Section 3.4.

California consumers and businesses would save more money on energy than they would spend to finance the efficiency measure from the start as this measure reduces build costs. As a result, this proposal would leave more money available for discretionary and investment purposes.

See Section 3.4 for the methodology, assumptions, and results of the cost-effectiveness analysis.

Statewide Energy Impacts: Energy, Water, and Greenhouse Gas (GHG) Emissions Impacts

Table 2 presents the estimated impacts of the proposed code change that would be realized statewide during the first 12 months that proposed requirement are in effect.

First-year statewide energy impacts are represented by the following metrics: electricity savings in gigawatt-hours per year (GWh/yr), peak electrical demand reduction in megawatts (MW), natural gas savings in million therms per year (million therms/yr), source energy savings in millions of kilo British thermal units per year (million kBtu/yr), and Long-term Systemwide Cost (LSC) savings in millions of 2026 present value dollars per year (million 2026 PV\$/yr). See Section 3.5 for more details on the first-year statewide impacts. Section 3.3.2 contains details on the per-unit energy savings.

Avoided GHG emissions are measured in metric tons of carbon dioxide equivalent (metric tons CO₂e). For this measure total avoided GHG emissions are 1,310 metric tons CO₂e. Assumptions used in developing the GHG savings are provided in Section 3.5.2. The monetary value of avoided GHG emissions is included in the LSC hourly factors provided by the CEC and is thus included in the cost-effectiveness analysis.

First-year statewide water savings are presented Section 3.5.3 along with the associated embedded electricity savings. Table 52 of this report presents water savings impacts. The methodology used to calculate embedded electricity in water is presented in Appendix B.

Table 2: Summary of Impacts for CPC Appendix M

Category	Metric	New Construction & Additions
Cost-Effectiveness	Benefit-to-Cost Ratio Range (varies by climate zone and building type)	Infinite
Statewide Impacts	First-Year Electricity Savings (GWh)	0.68
	First-Year Peak Electrical Demand Reduction (MW)	0.08
	First-Year Natural Gas Savings (Million Therms)	0.21
	First-Year Source Energy Savings (Million kBtu)	19.9
	30-Year LSC Electricity Savings from Buildings Constructed in First Year Code is in Effect (Million 2026 PV\$)	4.6
	30-Year LSC Gas Savings from Buildings Constructed in First Year Code is in Effect (Million 2026 PV\$)	24.8
	30-Year Total LSC Savings from Buildings Constructed in First Year Code is in Effect (Million 2026 PV\$)	29.4
	First-Year Avoided GHG Emissions (Metric Tons CO ₂ e)	1,310
	Monetary Value of Avoided GHG Emissions during First year (\$)	161,336
	First-Year On-site Indoor Water Savings (Gallons)	9,296,024
	First-Year On-site Outdoor Water Savings (Gallons)	-
	First-Year Embedded Electricity in Water Savings (kWh)	50,570
	Per Dwelling Unit Impacts	Annual Electricity Savings (kWh)
Annual Peak Electrical Demand Reduction (W)		13.3
Annual Natural Gas Savings (kBtu)		709
Annual Source Energy Savings (kBtu)		836
30-Year LSC Savings (2026 PV\$)		1,603
Annual Avoided GHG Emissions (kg CO ₂ e)		53.0
Annual On-site Indoor Water Savings (Gallons)		263
Annual On-site Outdoor Water Savings (Gallons)		-
Annual Embedded Electricity in Water Savings (kWh)		1.43

Compliance and Enforcement

Overview of Compliance Process

The compliance process is described in Section 3.1.5. Impacts that the proposed measure would have on market actors is described in Section 3.2. The Statewide CASE Team worked with stakeholders to develop a recommended compliance and enforcement process and to identify the impacts this process would have on various market actors.

The key issues related to compliance and enforcement are summarized below:

- **Design Phase:** Plumbing designers would perform pipe sizing calculations and design tasks based on CPC Appendix M method. This method is like the existing Appendix A process, except the fixture unit calculation and use of Hunter's curve chart is substituted by the IAPMO WDC spreadsheet to calculate flow rate for each section of pipe. The rest of the pipe sizing process to determine the number of fixtures and size pipe diameter for each pipe section based on water velocity and pressure drop remains unchanged.
- **Permit Application Phase:** Plumbing designers would provide design documentation. Designers would indicate on the compliance form which plumbing plan sheets include the IAPMO calculations. Building department plan inspector would need to understand and review Appendix M sizing reported in the LMCC/NRCC compliance form.

Addressing Energy Equity and Environmental Justice

The Statewide CASE Team assessed the potential impacts of the proposed measure on DIPs utilizing data from the [CalEnviroScreen website](#) indicating how DIPs may be disproportionately affected, as well as studies showing how DIPs may be more susceptible to health and quality of life impacts, including [The Greening Institute: Equitable Building Electrification](#) and other studies.

As a result of this measure, the Statewide CASE Team determined the DIPs would benefit in the following ways:

- The measure results in lower construction costs for new construction, which may be passed on as lower rent or purchase price, which would positively impact low-income households and residents in low-income census tracts.
- The measure results in energy cost savings in all climate zones, which would provide a higher benefit to people in low-income households and low-income census tracts who spend a higher percentage of their income on energy than the general population.
- The measure results in improved hot water delivery performance, reducing excess water use and risk of waterborne pathogens which would provide a higher benefit to the people in low-income households and low-income census tracts who spend a higher percentage of their income on utilities than the general population and may have increased healthcare costs.

Full details addressing energy, equity, and environmental justice can be found in Section 3.6 of this report.

Pipe Insulation Enhancement

Proposal Description

Pipe insulation enhancement is a combination of two measures including field verification and code language cleanup.

Proposed Code Change

The first component investigates the mandatory pipe insulation requirements contained under Title 24, Part 6, Section 160.4 for possible cleanup. The second component is a proposed mandatory requirement for field verification that would confirm installation of code required pipe insulation and overall insulation installation quality.

This proposed mandatory measure would apply to newly constructed buildings only. The measure would add field verification, but no acceptance tests. The proposal would require minor updates to the compliance software.

Justification

The current multifamily mandatory pipe insulation code language does not include key details of what type of DHW system piping shall be insulated or if appurtenances and pipe support require proper insulation. Clear insulation language and continuous pipe insulation requirements would streamline the field verification process.

Field verification of pipe insulation installation quality would ensure uniform building industry installation practices and minimize pipe heat loss for the effective useful life of the distribution system. The pipe insulation verification component stems from the poor quality of existing insulation exhibited by the 2013 PIER Report “Multifamily Central Domestic Hot Water Distribution Systems” (PIER 2013) and the 2022 Statewide CASE Team data collection, including stakeholder feedback during the CASE process.

Background Information

The mandatory insulation code language for multifamily buildings was consolidated in 2022 Title 24, Part 6 Section 160.4 from Section 150.0 of the 2019 low-rise residential code and Section 120.3 of the nonresidential/high-rise multifamily code. A significant portion of the 120.3 general requirements for pipe insulation code language was unintentionally omitted from 160.4 and is now limited to one sentence that reads, “*Piping for multifamily domestic hot water systems, shall be insulated to meet the requirements of Table 160.4-A*”.

In the 2019 Title 24, Part 6, Section 120.3, the code language was expanded to include an expanded section on HVAC pipe insulation that included “Fluid distribution systems, insulating elements that are in series with the fluid flow, such as pipes, pumps, valves, strainers...”. The Statewide CASE Team uses the term “appurtenances” to describe

these pipe components for DHW systems for this proposal. In the 2016 code update cycle, language was added to Section 12

0.3 for DHW insulation that included requirements for insulating the recirculation system piping, the first eight feet of hot and cold outlet piping and externally heated pipes, but there was no mention of insulating DHW system appurtenances.

American Society of Heating, Refrigerating and Air-Conditioning Engineers (ASHRAE) 90.1 contains pipe insulation language in Section 7.4.3 for DHW systems and Section 6.4.4.1.3 for HVAC systems. Section 7.4.3 includes the same DHW insulation language as 120.3 and additionally includes language that the first eight feet of branch piping connected to piping that carries recirculated water shall be insulated. Section 6.4.4.1.3 adds that “all piping associated with HVAC systems must be thermally insulated for heat and hot-water systems and for cooling, brine and refrigerant systems.” In the exceptions section it states that insulation is not regulated in the following cases that includes: “Strainers, control valves, and balancing valves in piping less than or equal to one inch in size. This allows for easy access to these devices.” This implies that “all piping” larger than 1” diameter, including some appurtenances such as strainers, control valves and balancing valves in series, must be thermally insulated for space conditioning systems.

Section 7.4.3 does not have a similar requirement for DHW systems. Thus, for multifamily buildings, the existing 2022 Section 160.4 pipe insulation code language leaves a lot for interpretation, making it difficult for designers to give consistent direction to contractors and for inspectors to understand what to verify.

Scope of Code Change Proposal

Table 3 summarizes the scope of the proposed changes and which sections of standards, Reference Appendices, Alternative Calculation Manual (ACM) Reference Manuals, and compliance documents that would be modified as a result of the proposed change(s). The proposed change would require enhanced insulation installation to include appurtenances and piping specialties such as valves and hangers. This would reduce further heat loss from the DHW piping system.

Table 3: Scope of Code Change Proposal – Pipe Insulation Enhancement

Type of Requirement	Mandatory
Applicable Climate Zones	All
Modified Section(s) of Title 24, Part 6	Section 160.4(f)
Modified Title 24, Part 6 Appendices	RA2.2, RA3.6.10
Would Compliance Software Be Modified	Yes, software would need to be modified to capture energy savings of enhanced insulation.

Modified Compliance Document(s)

- 2022-LMCC-PLB-E: Domestic Water Heating
- 2022-NRCC-PLB-E: Domestic Water Heating
- 2022-LMCI-PLB-E: Domestic Water Heating
- 2022-NRCI-PLB-E: Domestic Water Heating
- 2022-LMCMV-PLB-21-HERS
- 2022-NRCV-PLB-21-HERS

Market Analysis and Regulatory Assessment

The 2025 Statewide CASE Team performed a market analysis by reviewing 40 building plans and conducting literature review with the goals of identifying current product availability, and market trends. The market analysis found that pipe insulation, insulation fabrication, and pipe support products are widely available for designers to specify and for contractors to procure, and many options are available for contractors to meet the pipe insulation code requirements through purchasing prefabricated products or fabricating materials onsite. The proposed code change would have a small impact on the building industry in general to incorporate comprehensive pipe insulation code requirements but delivers significant additional energy savings over the life of the building. Based on reviewed plans, designers are specifying piping insulation to varying degrees above code requirements for most buildings.

Pipe insulation currently covers all supply and return pipes, and fittings in Title 24, Part 6, Section 160.4. The existing code lacks language for some specific sections of the piping system. As an example, there is no specific language mentioning the requirement for adding continuous pipe insulation to cover the heating plant, appurtenances, pipe supports, and branch piping leading from the loop. This measure would require increased attention to detail by pipe insulation contractors to ensure that insulation is complete and well installed.

Current pipe insulation design specifications and drawings are available and comprehensive on a few plans and limited on many building plans reviewed. This general lack of pipe insulation specification is likely a result of unclear pipe insulation code language in current and prior versions of the energy code. Part of the solution is the explicit code language proposed, which the designer can supplement with detailed drawings and instructions. Training could be provided to the design community on new code requirements and best practice plumbing design materials to ensure comprehensive information is passed on to the contractor.

The Statewide CASE Team believes that the addition of explicit mandatory pipe insulation language that requires continuous pipe insulation would make it easier to complete field verification of pipe insulation installation, since the insulation requirements are clear and consistent, and all the heating plant and hot water distribution piping would be insulated with no gaps for easy visual inspection. This

proposed pipe verification component requires a window of time where pipe insulation is exposed before drywall installation. If phasing is an issue, general contractors would need to coordinate subcontractor schedules to allow for pipe insulation verification by a HERS Rater. Refer to Section 4.2.4 for details.

Cost-Effectiveness

The proposed code change was found to be cost effective for all climate zones where it is proposed to be required. The benefit-to-cost (B/C) ratio over the 30-year period of analysis is >1 for a heat pump water heater as well as a gas water heater for all climate zones. See more details in Section 4.4.

California consumers and businesses would save more money on energy than they would spend to finance the efficiency measure. As a result, over time this proposal would leave more money available for discretionary and investment purposes once the initial cost is paid off.

See Section 4.4 for the methodology, assumptions, and results of the cost-effectiveness analysis.

Statewide Energy Impacts: Energy, Water, and Greenhouse Gas (GHG) Emissions Impacts

Table 4 presents the estimated impacts of the proposed code change that would be realized statewide during the first 12 months that proposed requirement are in effect.

First-year statewide energy impacts are represented by the following metrics: electricity savings in gigawatt-hours per year (GWh/yr), peak electrical demand reduction in megawatts (MW), natural gas savings in million therms per year (million therms/yr), source energy savings in millions of kilo British thermal units per year (million kBtu/yr), and Long-term Systemwide Cost (LSC) savings in millions of 2026 present value dollars per year (million 2026 PV\$/yr). See Section 4.5 for more details on the first-year statewide impacts. Section 4.3.2 contains details on the per-unit energy savings.

Avoided GHG emissions are measured in metric tons of carbon dioxide equivalent (metric tons CO₂e). For this measure total avoided GHG emissions are 2,637 metric tons CO₂e. Assumptions used in developing the GHG savings are provided in Section 4.5.2. The monetary value of avoided GHG emissions is included in the LSC hourly factors provided by the CEC and is thus included in the cost-effectiveness analysis.

Table 4: Summary of Impacts for Pipe Insulation Enhancement

Category	Metric	New Construction & Additions
Cost-Effectiveness	Benefit-to-Cost Ratio Range (varies by climate zone and building type)	3-9
Statewide Impacts	First-Year Electricity Savings (GWh)	1.1
	First-Year Peak Electrical Demand Reduction (MW)	0.12
	First-Year Natural Gas Savings (Million Therms)	0.42
	First-Year Source Energy Savings (Million kBtu)	40
	30-Year LSC Electricity Savings from Buildings Constructed in First Year Code is in Effect (Million 2026 PV\$)	7.1
	30-Year LSC Natural Gas Savings from Buildings Constructed in First Year Code is in Effect (Million 2026 PV\$)	50.5
	30-Year Total LSC Savings from Buildings Constructed in First Year Code is in Effect (Million 2026 PV\$)	57.6
	First-Year Avoided GHG Emissions (Metric Tons CO ₂ e)	2,637
	Monetary Value of Avoided GHG Emissions during First Year (\$)	324,700
	First-Year On-site Indoor Water Savings (Gallons)	-
	First-Year On-site Outdoor Water Savings (Gallons)	-
	First-Year Embedded Electricity in Water Savings (kWh)	-
Per Dwelling Unit Impacts	Annual Electricity Savings (kWh)	174
	Annual Peak Electrical Demand Reduction (W)	20.7
	Annual Natural Gas Savings (kBtu)	1,443
	Annual Source Energy Savings (kBtu)	1,606
	30-Year LSC Savings (2026 PV\$)	2,899
	Annual Avoided GHG Emissions (kg CO ₂ e)	103
	Annual On-site Indoor Water Savings (Gallons)	-
	Annual On-site Outdoor Water Savings (Gallons)	-
	Annual Embedded Electricity in Water Savings (kWh)	-

Compliance and Enforcement

Overview of Compliance Process

The compliance process is described in Section 4.1.5. Impacts that the proposed measure would have on market actors is described in 4.2. The Statewide CASE Team worked with stakeholders to develop a recommended compliance and enforcement process and to identify the impacts this process would have on various market actors.

The key issues related to compliance and enforcement are summarized below:

- **Design Phase:** Designers currently reference Title 24, Part 6 pipe insulation requirements and insulation thickness table. A minority of designers identify comprehensive pipe insulation requirements including insulation material and pipe support specifications, custom pipe insulation requirements for sections not explicitly covered by code, and supplemental drawings and tables. Designers need to complete the LMCC-PLB-01-E or NRCC-PLB-01-E compliance documents, which now would include an expanded pipe insulation section.
- **Permit Application Phase:** Energy consultants make the desired pipe insulation verification selection (Y/N) in the compliance software for the project when using the performance approach, and the information is submitted as part of the permit application package.
- **Construction Phase:** The contractor would follow permitted building plans and assemble and fabricate pipe insulation as specified. The requirements relating to appurtenances and pipe supports and quality installation practices are significant and would require additional procurement, coordination, and installation time and may require staff training. Contractors would populate and sign the LMCI-PLB-01-E or NRCI-PLB-01-E forms marking off the completion of the mandatory pipe insulation requirements.
- **Inspection Phase:** HERS Rater would need to coordinate and schedule verification visits with contractors or general contractors to ensure mandatory pipe insulation requirements are followed during construction. HERS Rater would populate the LMCV/NRCV form, and after the verification visits, both the HERS Rater and contractors would provide signatures for the compliance form.

Addressing Energy Equity and Environmental Justice

The Statewide CASE Team assessed the potential impacts of the proposed measure on DIPs utilizing data from the [CalEnviroScreen website](#) indicating how DIPs may be disproportionately affected, as well as studies showing how DIPs may be more susceptible to health and quality of life impacts, including [The Greenling Institute: Equitable Building Electrification](#) and other studies.

As a result of this measure, the Statewide CASE Team determined the DIPs would benefit in the following ways:

Higher Upfront Costs

The measure results in marginally higher upfront costs for new construction in most cases, which would most likely not be passed on as higher rent or purchase price, and they would not impact low-income households and residents in low-income census tracts.

Reduction in Energy Costs

The measure results in energy cost savings in all climate zones, which would provide a higher benefit to people in low-income households and low-income census tracts who spend a higher percentage of their income on energy than the general population.

Improved Hot Water Delivery Performance

The measure results in improved hot water delivery performance and reduced noise, which would provide a higher benefit to the people in low-income households and low-income census tracts who spend a higher percentage of their income on utilities than the general population and may have increased healthcare costs.

Job Creation

This measure would create more installation jobs for pipe insulation contractors.

Full details addressing energy, equity, and environmental justice can be found in Section 4.6 of this report.

Thermostatic Balancing Valves

Proposal Description

The proposal would add a new compliance option for smaller recirculation systems serving multi-riser central DHW systems in multifamily buildings. For additions and alterations projects the same criteria apply. The project would be applicable for the compliance credit if the design team works to meet the criteria and document that the criteria is met.

Proposed Code Change

To receive the compliance credit the project must include:

1. More than one DHW supply riser
2. Each DHW supply riser shall have an accessible thermostatic balancing valve (TBV)
 - a. Located after the last supply branch from the supply riser, in the direction of flow.
 - b. Set to a maximum temperature of 120 °F.
3. Variable speed hot water return circulating pumps specified to operate with differential pressure control.
4. For systems with one return pipe loop, hot water return piping that does not exceed 225 feet developed length.

5. For systems with multiple recirculation return pipe loops, no return pipe may exceed 225 feet developed length.

The compliance option would apply for new construction, and to additions and alterations. For additions and alterations, the compliance option would be most feasible when the scope of work includes:

1. Replacement of the existing water heater
2. Addition of new plumbing fixtures that require hot water.

Justification

This proposal would save energy while reducing first costs and installation time as described in Section 5.4.3, improving delivery performance of the hot water distribution system, and reducing callbacks. The proposal would also benefit water heater equipment efficiency due to lower return temperatures, although this energy benefit was not quantified for this report.

Several of the stakeholders the Statewide CASE Team interviewed switched to specifying or installing TBVs within the last five years. However, the Statewide CASE Team heard from one stakeholder that manual balancing valves are still common practice in new buildings and that many existing buildings do not have any balancing valves.

From the plans review the Statewide CASE Team performed, it found that engineers do not typically calculate the flow rate that is required to maintain a target minimum temperature in the hot water recirculation system, but rather specify an overly conservative rule of thumb flow rate through each riser or fail to specify any flow rate. This results in recirculation system temperatures that are higher than necessary, and energy savings when TBVs are installed as opposed to manual balancing valves.

Background Information

This proposal adds a new compliance option to improve on current industry practice related to balancing of multi-riser systems and would increase adoption of TBVs in these systems. This proposal was previously investigated by the 2022 Statewide CASE Team, and it was not pursued because there were minimal energy savings due to the existing prescriptive circulation pump control (demand control) requirements.

In October 2020, the Statewide CASE Team learned that the 2022 standard design in the compliance modeling software was updated in early 2020 to assume no demand control. Due to the change to the standard design, the 2025 Statewide CASE Team worked with the CEC to establish an appropriate baseline of no demand control and enable the calculation of energy savings for this measure.

Scope of Code Change Proposal

Table 5 summarizes the scope of the proposed changes and which sections of standards, Reference Appendices, Alternative Calculation Manual (ACM) Reference Manuals, and compliance documents that would be modified as a result of the proposed change(s).

Table 5: Scope of Code Change Proposal – Require Balance Valves

Type of Requirement	Compliance credit option
Applicable Climate Zones	All
Modified Section(s) of Title 24, Part 6	Section 170.1
Modified Title 24, Part 6 Appendices	RA 4.4.3 ACM Appendix E
Would Compliance Software Be Modified	Yes Currently there is no requirement to provide ABV in DHW piping system. Software would need to be updated to reflect energy savings achieved by installation of ABV
Modified Compliance Document(s)	<ul style="list-style-type: none"> • 2022-LMCC-PRF-01-E: Domestic Water Heating • 2022-NRCC-PRF-E: Domestic Water Heating • 2022-LMCI-PLB-E: Domestic Water Heating • 2022-NRCI-PLB-E: Domestic Water Heating

Market Analysis and Regulatory Assessment

The Statewide CASE Team performed a market analysis with the goals of identifying current technology availability, current product availability, and market trends. It then considered how the proposed standard may impact the market in general as well as individual market actors. The Statewide CASE Team interviewed three designers, one design consultant, one plumbing contractor, and one general contractor to understand the current market. The Statewide CASE Team also reviewed 16 plans from real world projects.

The Statewide CASE Team determined that TBV and variable speed pumps are currently available on the market. For instance, TBV were specified in 4 of 16 plans reviewed, and 3 of 7 stakeholders interviewed use thermal balancing valves in some of their projects. Furthermore, the Statewide CASE Team found products from at least 5 manufacturers of TBV that are available within the state. Variable speed pumps were specified in 7 of 16 plans reviewed.

Adoption of this code change proposal would result in relatively modest economic impacts through the additional direct spending by those in the residential building and remodeling industry as well as indirectly as residents spend all or some of the money saved through lower utility bills on other economic activities. Refer to Section 4.2.4 for details.

This proposal is not relevant to other parts of the California Building Standards Code (<https://www.dgs.ca.gov/BSC/Codes>). Changes outside of Title 24, Part 6 are not needed. There are no relevant state or local laws or regulations, and there is no conflict with the current CPC. There are no other code change proposals under consideration for the 2025 code cycle that overlap with this proposal.

Cost-Effectiveness

The proposed code change was found to be cost effective for all climate zones where it is proposed. The benefit-to-cost (B/C) ratio over the 30-year period of analysis is >1 for a heat pump water heater as well as a gas water heater for all climate zones. See more details in Section 5.4.

California consumers and businesses would save more money on energy than they would spend to finance the efficiency measure. As a result, over time this proposal would leave more money available for discretionary and investment purposes once the initial cost is paid off.

See Section 5.4 for the methodology, assumptions, and results of the cost-effectiveness analysis.

Statewide Energy Impacts: Energy, Water, and Greenhouse Gas (GHG) Emissions Impacts

Table 6 present the estimated impacts of the proposed code change that would be realized statewide during the first 12 months that proposed requirement are in effect.

First-year statewide energy impacts are represented by the following metrics: electricity savings in gigawatt-hours per year (GWh/yr), peak electrical demand reduction in megawatts (MW), natural gas savings in million therms per year (million therms/yr), source energy savings in millions of kilo British thermal units per year (million kBtu/yr), and LSC savings in millions of 2026 present value dollars per year (million 2026 PV\$/yr). See Section 5.5 for more details on the first-year statewide impacts. Section 5.3.2 contains details on the per-unit energy savings.

Avoided GHG emissions are measured in metric tons of carbon dioxide equivalent (metric tons CO₂e). For this measure total avoided GHG emissions are 75 metric tons CO₂e. Assumptions used in developing the GHG savings are provided in Section 5.5.2. The monetary value of avoided GHG emissions is included in the LSC hourly factors provided by the CEC and is thus included in the cost-effectiveness analysis.

Table 6: Summary of Impacts for Thermostatic Balancing Valves

Category	Metric	New Construction & Additions	Alterations
Cost-Effectiveness	Benefit-to-Cost Ratio Range (varies by climate zone and building type)	Infinite	Infinite
Statewide Impacts	First-Year Electricity Savings (GWh)	0.01	0.06
	First-Year Peak Electrical Demand Reduction (MW)	0.00	0.01
	First-Year Natural Gas Savings (Million Therms)	0.00	0.01
	First-Year Source Energy Savings (Million kBtu)	0.13	1.0
	30-Year LSC Electricity Savings from Buildings Constructed in First Year Code is in Effect (Million 2026 PV\$)	0.05	0.42
	30-Year LSC Natural Gas Savings from Buildings Constructed in First Year Code is in Effect (Million 2026 PV\$)	0.15	1.2
	30-Year Total LSC Savings from Buildings Constructed in First Year Code is in Effect Million 2026 PV\$)	0.20	1.6
	First-Year Avoided GHG Emissions (Metric Tons CO2e)	8.5	67.0
	Monetary Value of Avoided GHG Emissions during First Year (\$)	1,041	8,253
	First-Year On-site Indoor Water Savings (Gallons)	-	-
	First-Year On-site Outdoor Water Savings (Gallons)	-	-
First-Year Embedded Electricity in Water Savings (kWh)	-	-	
Per Dwelling Unit Impacts	Annual Electricity Savings (kWh)	14.8	16.2
	Annual Peak Electrical Demand Reduction (W)	1.7	1.9
	Annual Natural Gas Savings (kBtu)	56.4	60.1
	Annual Source Energy Savings (kBtu)	76.6	82.2
	30-Year LSC Savings (2026 PV\$)	167	181
	Annual Avoided GHG Emissions (kg CO2e)	4.7	5.1
	Annual On-site Indoor Water Savings (Gallons)	-	-
	Annual On-site Outdoor Water Savings (Gallons)	-	-
	Annual Embedded Electricity in Water Savings (kWh)	-	-

Compliance and Enforcement

Overview of Compliance Process

When developing this proposal, the Statewide CASE Team considered methods to streamline the compliance and enforcement process and how negative impacts on market actors who are involved in the process could be mitigated or reduced. This section describes how to comply with the proposal. It also describes the compliance verification process. Appendix E presents how the proposed changes could impact various market actors.

The compliance verification activities related to this measure that need to occur during each phase of the project are described below:

- **Design Phase:**
 - The plumbing engineer designs the buildings plumbing systems. Since manual balancing valves are standard practice, certain design aspects such as coordinating access to balancing valves, are currently performed, and not considered new activities. To receive a compliance credit the proposal would require the plumbing engineer to specify thermal balancing valves, design the DHW supply and return piping to meet the criteria outlined in the ACM, accurately determine length of each return pipe loop, specify the circulation riser temperature set point and a variable speed circulation system pump with differential pressure control, and coordinate with the energy compliance professional to ensure compliance credit is received. The plumbing engineer would also need to coordinate with the plumbing subcontractor to ensure that the design length is achieved in the field.
 - The plumbing engineer would also coordinate with the energy consultant and contribute content for the applicable LMCC or NRCC compliance forms based on the project details.
- **Permit Application Phase:**
 - Plan checkers currently perform plan check reviews of the hot water distribution system and verify that the construction documents meet the requirements of current buildings codes. The proposal would add new activities to this phase, including requiring plan checkers to verify that the design team has met the criteria of designing around a thermal balancing valve and variable speed pump to claim the compliance credit. The LMCC and NRCC forms would assist the plan checkers in verifying that new projects meet the requirements of the proposal.
- **Construction Phase:**

- Plumbing subcontractors currently install the DHW system, including furnishing and installing the specified balancing valves and circulation pumps. One significant change associated with this proposal is that the plumbing subcontractor would need to attest in the project compliance forms that the length of each return pipe loop as built does not exceed the calculated length specified in the construction documents. The plumbing subcontractor would also need to install a variable speed circulation pump and ensure the pump control is set appropriately as required for the project to receive compliance credit. The plumbing subcontractor would also need to install the thermal balancing valves; The Statewide CASE Team heard from designers and contractors that thermal balancing valves are easier to properly install than manual balancing valves. Finally, the plumbing subcontractor would need to fill out the applicable LMCI or NRCI forms.
- **Inspection Phase:**
 - The inspector typically reviews the applicable LMCI or NRCI forms and verifies that certain details of the distribution system comply with the building code. This proposal would add fields to the LMCI and NRCI forms and require the inspector to verify that the balancing valve and circulation pump products match the inputs in the applicable LMCI or NRCI form and that the temperature set point meets the proposed requirements.

Field Verification and Diagnostic Testing/Acceptance Testing

There are no field verifications or acceptance tests involved with this proposal.

Addressing Energy Equity and Environmental Justice

The Statewide CASE Team assessed the potential impacts of the proposed measure on DIPs utilizing data from the [CalEnviroScreen website](#) indicating how DIPs may be disproportionately affected, as well as studies showing how DIPs may be more susceptible to health and quality of life impacts, including [The Greenling Institute: Equitable Building Electrification](#) and other studies.

As a result of this measure, the Statewide CASE Team determined the DIPs would benefit in the following ways:

Lower First Cost of Construction

The measure results in lower construction costs for new construction due to reduced labor time to balance thermal balancing valves as opposed to manual balancing valves, and resultant labor cost savings that offset marginal material cost increases. These cost savings may be passed on as lower rent or purchase price, which would positively impact low-income households and residents in low-income census tracts.

Reduction in Energy Costs

The measure results in energy cost savings in all climate zones, which would provide a higher benefit to people in low-income households and low-income census tracts who spend a higher percentage of their income on energy than the general population.

Improved Hot Water Delivery Performance

The measure results in improved hot water delivery performance, reducing excess water use and risk of waterborne pathogens, which would provide a higher benefit to the people in low-income households and low-income census tracts who spend a higher percentage of their income on utilities than the general population and who may have increased healthcare costs.

Require Master Mixing Valves

Proposal Description

This prescriptive measure would require the installation of a thermostatic master mixing valve (MMV) that conforms to the American Society of Sanitation Engineers (ASSE) 1017-2009 standard, *Performance Requirements for Temperature Actuated Mixing Valves for Hot Water Distribution Systems*.

Proposed Code Change

The proposed code change would impact Section 170.2(d) - Prescriptive Approach for Water Heating Systems. The MMV must be installed on the central heating plant hot water supply outlet header leading to the recirculation loop. The MMV shall be installed and commissioned in accordance with manufacturer's instructions and applicable reference appendix. The plumbing plans shall provide MMV installation details and specifications indicating water mixing parameters, if this exceeds the mixing capability of the specified MMV, the designer shall provide valve commissioning instructions to prevent temperature creep.

Justification

Laboratory testing has shown significant energy savings when a MMV is installed at the heating plant hot water outlet supply line prior to centralized supply and return distribution system, versus mixing downstream at the dwelling unit.

MMVs are already commonly specified and installed in central domestic water heating systems with recirculation and conform to ASSE 1017-2209. Based on our review of 22 new construction and retrofit project plumbing drawings, 82 percent of those designs (18 of 22 projects) included MMV (2 digital, 16 mechanical) in the DHW heating plant design, 2 projects utilized MMV at each dwelling unit, and 2 projects did not use MMV.

This proposed measure seeks to codify what is already considered to be good practice and more cost effective than individual MMV installation at each dwelling unit. With the advance towards central HPWH systems, the use of MMV to precisely control the distribution supply temperature offers higher system COP, load shifting capabilities, and ability to safely increase storage heating capacity, and it improves reliability of single pass heat pumps in certain recirculation return to primary tank design applications.

Background Information

Designers commonly specify mechanical MMV that utilize paraffin wax or bi-metal designs located on the hot water heating plant outlet header leading to a centralized distribution system with recirculation. This design offers the simplest solution to controlling the temperature in the recirculation loop. While the technology and performance standards of gas and electric water heaters have greatly improved, the MMV performance standard (ASSE 1017) has not improved significantly to cover valve performance when utilized in a DHW continuous recirculation system application despite technology improvements, especially with the introduction of digital mixing valves.

The proposed prescriptive requirement is complimentary to several leading HPWH manufacturers' installation guidelines. The Northwest Energy Efficiency Alliance's (NEEA) Advanced Water Heating Specification 8.0 (NEEA 2022) defines four major components of a central HPWH system, including (1) primary heating system, (2) primary storage, (3) temperature maintenance system, and (4) controls and sensors. Thermostatic mixing valves are a required component of the temperature maintenance system. Historically, mixing valves are used to mitigate pathogen growth and scalding risk. With the advance towards central HPWH systems, the use of advanced mixing valves to precisely control the distribution supply and return temperatures offers additional heating plant performance benefits including temperature creep mitigation and distribution loop pipe heat loss savings.

Scope of Code Change Proposal

Table 7 summarizes the scope of the proposed changes and which sections of standards, Reference Appendices, Alternative Calculation Manual (ACM) Reference Manuals, and compliance documents that would be modified as a result of the proposed change(s).

Table 7: Scope of Code Change Proposal – Master Mixing Valves

Type of Requirement	Prescriptive
Applicable Climate Zones	All
Modified Section(s) of Title 24, Part 6	170.2(d)
Modified Title 24, Part 6 Appendices	RA4.4.20
Would Compliance Software Be Modified	Yes. If selecting to not design with a thermostatic MMV, the software would need to be modified to add an energy penalty. Nonresidential and Multifamily Alternative Calculation Method Reference Manual 6.11 DHW
Modified Compliance Document(s)	<ul style="list-style-type: none"> • 2022-LMCC-PLB-E: Domestic Water Heating • 2022-NRCC-PLB-E: Domestic Water Heating • 2022-LMCI-PLB-E: Domestic Water Heating • 2022-NRCI-PLB-E: Domestic Water Heating

Market Analysis and Regulatory Assessment

The Statewide CASE Team interviewed five plumbing designers and one general contractor with a set of MMV-related questions and conducted plans review of 45 buildings. Currently, the specification and installation of mixing valves is considered good engineering practice. Designers are specifying and contractors are installing MMVs in the majority of the DHW systems that the Statewide CASE Team has reviewed. MMVs, when specified, are done so by the plumbing designer. The plumbing contractor is responsible for the installation of the valve.

Based on the lab testing results in Section 6.2.2.4, the installation of MMVs results in a 10.5 percent energy savings over not installing one in a HPWH system and distribution system that mimics a building with 44-dwelling units. MMVs are already being specified and installed in the majority of central DHW systems, based on 45 new building project drawings the Statewide CASE Team reviewed.

The 2022 CPC Sections 408.3 and 409.4 discuss the need for thermostatic mixing for scald protection, but they do not specify the location where mixing is required. This proposal does not conflict with the CPC or other parts of the California Energy Standards (<https://www.dgs.ca.gov/BSC/Codes>). Changes outside of Title 24, Part 6 are not needed. There are no relevant state or local laws or regulations, and there is no conflict with the current CPC. There are no other code change proposals under consideration for the 2025 code cycle that overlap with this proposal.

Adoption of this code change proposal would result in relatively modest economic impacts through the additional direct spending by those in the residential building and remodeling industry, as well as indirectly as residents spend all or some of the money saved through lower utility bills on other economic activities. There may also be some

nonresidential customers that are impacted by this proposed code change. Refer to Section 6.2.4 for more details.

Cost-Effectiveness

The proposed code change was found to be cost-effective for all climate zones where it is proposed. The benefit-to-cost (B/C) ratio over the 30-year period of analysis is >1 for a heat pump water heater as well as a gas water heater for all climate zones. See more details in Section 6.4.

California consumers and businesses would save more money on energy than they would spend to finance the efficiency measure. As a result, over time this proposal would leave more money available for discretionary and investment purposes once the initial cost is paid off.

See Section 6.4 for the methodology, assumptions, and results of the cost-effectiveness analysis.

Statewide Energy Impacts: Energy, Water, and Greenhouse Gas (GHG) Emissions Impacts

Table 8 presents the estimated impacts of the proposed code change that would be realized statewide during the first 12 months that proposed requirement are in effect.

First-year statewide energy impacts are represented by the following metrics: electricity savings in gigawatt-hours per year (GWh/yr), peak electrical demand reduction in megawatts (MW), natural gas savings in million therms per year (million therms/yr), source energy savings in millions of kilo British thermal units per year (million kBtu/yr), and LSC savings in millions of 2026 present value dollars per year (million 2026 PV\$/yr). See Section 6.5 for more details on the first-year statewide impacts. Section 6.3.2 contains details on the per-unit energy savings.

Avoided GHG emissions are measured in metric tons of carbon dioxide equivalent (metric tons CO₂e). For this measure total avoided GHG emissions are 2,468 metric tons CO₂e. Assumptions used in developing the GHG savings are provided in Section 6.5.2. The monetary value of avoided GHG emissions is included in the LSC hourly factors provided by the CEC and is thus included in the cost-effectiveness analysis. First-year statewide water savings are presented Section 6.5.3 along with the associated embedded electricity savings.

Table 8: Summary of Impacts for Master Mixing Valves

Category	Metric	New Construction & Additions
Cost-Effectiveness	Benefit-to-Cost Ratio Range (varies by climate zone and building type)	1-39
Statewide Impacts	First-Year Electricity Savings (GWh)	0.65
	First-Year Peak Electrical Demand Reduction (MW)	0.38
	First-Year Natural Gas Savings (Million Therms)	0.31
	First-Year Source Energy Savings (Million kBtu)	29.8
	30-Year LSC Electricity Savings from Buildings Constructed in First Year Code is in Effect (Million 2026 PV\$)	17.6
	30-Year LSC Natural Gas Savings from Buildings Constructed in First Year Code is in Effect (Million 2026 PV\$)	42.7
	30-Year Total LSC Savings from Buildings Constructed in First Year Code is in Effect (Million 2026 PV\$)	60.4
	First-Year Avoided GHG Emissions (Metric Tons CO ₂ e)	2,468
	Monetary Value of Avoided GHG Emissions during First Year (\$)	303,881
	First-Year On-site Indoor Water Savings (Gallons)	-
	First-Year On-site Outdoor Water Savings (Gallons)	-
	First-Year Embedded Electricity in Water Savings (kWh)	-
Per Dwelling Unit Impacts	Annual Electricity Savings (kWh)	107
	Annual Peak Electrical Demand Reduction (W)	62.3
	Annual Natural Gas Savings (kBtu)	1,068
	Annual Source Energy Savings (kBtu)	1,155
	30-Year LSC Savings (2026 PV\$)	4,374
	Annual Avoided GHG Emissions (kg CO ₂ e)	123
	Annual On-site Indoor Water Savings (Gallons)	-
	Annual On-site Outdoor Water Savings (Gallons)	-
	Annual Embedded Electricity in Water Savings (kWh)	-

Compliance and Enforcement

Overview of Compliance Process

When developing this proposal, the Statewide CASE Team considered methods to streamline the compliance and enforcement process and how negative impacts on market actors who are involved in the process could be mitigated or reduced. This section describes how to comply with the proposal. It also describes the compliance verification process. Appendix E presents how the proposed changes could impact various market actors.

The compliance verification activities related to this measure that need to occur during each phase of the project are described below:

- **Design Phase:** The licensed engineer of record for the plumbing design (plumbing designer) specifies the master mixing valve product and shall indicate in a schedule or on the plans water mixing parameters such as the hot water supply temperature, mixed outlet and return temperature, and recirculation flow rate to quantify the water mix ratio required to ensure the specified MMV does not exceed the mixing capability of the valve. This would be new information being added to the construction documents as this information is not currently included. Additionally, if pursuing performance compliance for DHW systems, the plumbing designer would communicate with the energy modeler if a digital MMV is used to gain the compliance credit. The plumbing designer helps complete LMCC or NRCC compliance documents. Energy consultants enter the appropriate MMV type in the compliance software if taking the performance approach, and the information is submitted as part of the application package. The energy consultant attests to the accuracy of the energy compliance documentation.
- **Permit Application Phase:** The plan checker would review the energy compliance documentation and design drawings to ensure compliance. The design around an MMV should be indicated on the compliance forms. And, as this is a prescriptive measure the appropriate penalty should be assessed if not specified in the design documents. Additionally, the plan checker would need to review the schedule sheet for the MMV schedule as well as the piping diagram showing the MMV in the piping design. Added work for the energy consultant includes new fields in existing energy compliance forms.
- **Construction Phase:** Moderate compliance or enforcement changes are anticipated as contractors currently install and commission MMVs regularly, but not always based on manufacturer's requirements for mechanical MMVs that often include detailed instructions for MMV startup and balancing valve commissioning. For digital MMVs, contractors would need to follow design documents and coordinate with manufacturer's representatives to ensure proper installation as well as programming and start-up. Certificate of Installation documents, LMCI/NRCI, would be completed by the installation contractor.
- **Inspection Phase:** Building inspector would need to inspect function of MMV to ensure proper operation prior to occupancy.

Addressing Energy Equity and Environmental Justice

The Statewide CASE Team assessed the potential impacts of the proposed measure on DIPs utilizing data from the [CalEnviroScreen website](#) indicating how DIPs may be disproportionately affected, as well as studies showing how DIPs may be more

susceptible to health and quality of life impacts, including [The Greenling Institute: Equitable Building Electrification](#) and other studies.

As a result of this measure, the Statewide CASE Team determined the DIPs would benefit in the following ways:

Higher Upfront Costs

The measure results in marginal higher upfront costs for new construction in most cases, which would most likely not be passed on as higher rent or purchase price, which would not economically impact low-income households and residents in low-income census tracts.

Reduction in Energy Costs

The measure results in energy cost savings in all climate zones, which would provide a higher benefit to people in low-income households and low-income census tracts who spend a higher percentage of their income on energy than the general population.

Improved Hot Water Delivery Performance

The measure results in improved hot water delivery performance, reduced incidents of scalding, and reduced risk of waterborne pathogens. This should provide a higher benefit to the people in low-income households and low-income census tracts who spend a higher percentage of their income on utilities than the general population and may have increased healthcare costs.

Job Creation

These two measures may create more installation and commissioning jobs for plumbers.

Central HPWH Clean-up

Proposal Description

This proposal suggests revising the prescriptive pathway(s) for alternative DHW plant design and control approaches as well as adding an alternative prescriptive pathway leveraging NEEA's Advanced Water Heating Specification V8.0 for commercial HPWH system.

Proposed Code Change

This measure would include the following prescriptive requirement for new construction multifamily buildings:

- Revise the existing prescriptive requirement to use single-pass HPWH as the primary HPWH equipment in DHW plant design, remove primary storage tank plumbing configuration requirement to allow design flexibility for HPWH, and clean-up recirculation loop tank heater requirements.
- Add alternative prescriptive pathway leveraging NEEA's Advanced Water Heating Specification V8.0 for commercial HPWH system to allow design flexibility, ensure system efficiency and reliability using prescriptive pathway. The alternative prescriptive requirement would require HPWH systems meeting NEEA AWHs V8.0 Tier 2.

This measure would not modify the standard central HPWH model in the compliance software.

Justification

With federal, state, local, and utility incentive programs, and a cultural drive towards reducing carbon emissions, the market for HPWHs in California has increased significantly over the last few years. The 2022 Title 24 Statewide All-Electric CASE research suggested central DHW systems are common in most multifamily buildings, except for those with a small number of dwelling units. Central HPWH systems are an important technology to decarbonize multifamily buildings. 2022 Title 24 Section 170.2 (d)2 already provides the prescriptive pathway for central HPWH systems. Since 2019, the central HPWH technology and applications have evolved significantly. With state regulations and local mandates moving to decarbonize buildings, many state and federal sponsored efforts have recently made performance data available to support evaluation of a wider range of systems and configurations, and incentivized manufacturers to improve product availability and reliability.

The measure proposal leveraged recent modeling capability, field study and lab testing data to evaluate HPWH equipment options and design configurations. The proposal provides a prescriptive pathway for potentially a wide range of configuration of the central HPWH system design supported by HPWH manufacturers. Contractors can select heat pump water heater systems that meet the configuration requirement in the proposed code language and comply with the code prescriptively. Note that for all HPWH systems, designers also have the option to comply using the performance approach.

The proposal would modify the requirements listed in Section 170.2(d)2 of the 2022 Title 24 code.

Background Information

For the 2022 code cycle, the Statewide CASE Team developed an alternate compliance pathway for central HPWH systems. The 2022 Title 24 code requires the Standard

Design be a central HPWH system if the Proposed Design uses central electric water heating and a gas central water heater if the Proposed Design uses natural gas. The 2022 code requirements establish a foundational structure for future code improvement.

The 2022 Title 24 prescriptive requirements include basic equipment, plumbing, control, and design documentation requirements to ensure minimum performance of the system. Building on the existing requirements, this measure proposal would investigate providing prescriptive pathway(s) for additional central HPWH plant design and control approaches.

The 2022 code includes Joint Appendix (JA) 14, which provides qualification requirements for a performance pathway for central HPWH systems. With the performance data requirement by JA14 under the 2022 code, the Statewide CASE Team proposed to revisit the prescriptive requirement for central HPWH design. NEEA developed a widely referenced Advance Water Heating Specification (AWHS) that originally only covered individual HPWHs, and they are currently developing their AWHS 8.0 to include multifamily central HPWH products (NEEA 2022). The specification includes commercial system efficiency calculation and requirements that consider performance of connected water heating, the primary plant, and temperature maintenance equipment. The Statewide CASE Team leveraged the NEEA AWHS 8.0 for code development of this efficiency requirement.

Scope of Code Change Proposal

Table 9 summarizes the scope of the proposed changes and which sections of standards, Reference Appendices, Alternative Calculation Manual (ACM) Reference Manuals, and compliance documents that would be modified as a result of the proposed change(s).

Table 9: Scope of Code Change Proposal – Central HPWH Clean-up

Type of Requirement	Prescriptive
Applicable Climate Zones	All
Modified Section(s) of Title 24, Part 6	Section 170.2(d)2
Modified Title 24, Part 6 Appendices	No
Would Compliance Software Be Modified	No
Modified Compliance Document(s)	<ul style="list-style-type: none"> • 2022-LMCC-PLB-E: Domestic Water Heating • 2022-NRCC-PLB-E: Domestic Water Heating • 2022-LMCI-PLB-E: Domestic Water Heating • 2022-NRCI-PLB-E: Domestic Water Heating

Market Analysis and Regulatory Assessment

The Statewide CASE Team performed a market analysis with the goals of identifying current technology availability, current product availability, and market trends. It then considered how the proposed standard may impact the market in general as well as individual market actors. The Statewide CASE Team also gathered information about the incremental cost of complying with the proposed measure. Estimates of market size and measure applicability were identified through research and outreach with stakeholders including utility program staff, CEC staff, and a wide range of industry actors. In addition to conducting personalized outreach, the Statewide CASE Team discussed the current market structure and potential market barriers during a public stakeholder meeting that the Statewide CASE Team held on February 17, 2023.

The main market actors include building owners/developers, design engineers, architects, contractors, equipment manufacturers, and energy consultants. In addition to traditional market actors, because central HPWH is a growing market, state and local government bodies and agencies with regulatory and program activities play an important role in the direction, pace, and rules around central HPWHs adoption. These market actors include IOUs, program implementers: Community choice aggregators and municipal utilities, researchers, state regulatory agencies and local governments.

The Statewide CASE Team performed a market analysis that covers commercial size HPWH units for central system design serving multiple dwelling units. The central heat pump water heating market in California is currently in a state of rapid growth and development. Based on the product review in this code cycle, Aermec, AO Smith, Colmac, Rheem, Nyle, Sanden units, Mitsubishi, Mayekawa, Lync, and Transom have products that are currently available in California or with near-term availability (see Figure 15). There are 57 currently or near-term available air-source HPWH that the Statewide CASE Team identified to be suitable for central HPWH application.

The product offering for low-global warming potential (GWP) heat pumps has been expanding. Based on the 2022 CASE Report, there were only 10 low-GWP air source HPWH products, and this number has doubled since 2019. There was only one manufacturer (Sanden) in 2019, which increased to five by 2022/2023:

- Nyle introduced e-series low GWP HPWHs e360 with R-513A refrigerant.
- Mitsubishi Electric Trane HVAC US introduced a large-capacity CO2 Heat pump Heat2O into U.S. market.
- Mayekawa also introduced UNIMO AW air heat source CO2 heat pump into the U.S. market.
- Lync introduced Aegis A series air source CO2 heat pump.
- Transom Hatch Air Sourced CO2 heat pump, manufacturer indicated model to be available by 2023.

Multiple other companies that sell central HPWH equipment in other markets (such as Asia, Europe, and Australia) have indicated to the Statewide CASE Team that they would be bringing those products to the California market in the next two years, as well as working to develop additional products.

The Statewide CASE Team compiled a list of recently constructed multifamily buildings with HPWH systems to understand current HPWH design practice and the application trends. For project data, the Statewide CASE Team collected information from review of design drawings and specifications from various data sources. The Statewide CASE Team identified common central HPWH plumbing configurations for multifamily applications, and they are consistent with four of the seven qualified piping configurations listed in AWHs 8.0 (NEEA 2022):

- Single-pass primary with electric resistance water heater in series for temperature maintenance system (HPWH_SPST)
- Single-pass return to primary (HPWH_SPRetP)
- Single-pass primary with multi-pass in parallel for temperature maintenance system (HPWH_SPwMPTM)
- Multi-pass return to primary (HPWH_MPRetP)

The Statewide CASE Team does not anticipate significant employment or financial impacts to any sector of the California economy. This is not to say that the proposed change would not have modest impacts on employment in California. Refer to section 7.2.4 for details.

Cost-Effectiveness

This measure does not propose mandatory requirement or a revision to the primary prescriptive requirements. A cost analysis is not necessary because the measure is not proposed to be part of the baseline level of stringency. The Statewide CASE Team provided information about the Cost-Effectiveness of the evaluated HPWH systems, even though the CEC does not require a cost-effectiveness analysis for the measure to be adopted.

See Section 7.4 for the methodology, assumptions, and results of the cost-effectiveness analysis.

Statewide Energy Impacts: Energy, Water, and Greenhouse Gas (GHG) Emissions Impacts

The code change proposal would not modify the stringency of the existing California Energy Code, so the savings associated with this proposed change are minimal.

Compliance and Enforcement

Overview of Compliance Process

The compliance process is described in Section 7.1.5. Impacts that the proposed measure would have on market actors are described in Section 7.2. The Statewide CASE Team worked with stakeholders to develop a recommended compliance and enforcement process and to identify the impacts this process would have on various market actors.

The key issues related to compliance and enforcement are summarized below:

- **Design Phase:** Design engineers (generally plumbing engineers) specify HPWH equipment and recirculation system design according to engineering analysis and manufacturer guidelines.
- **Permit Application Phase:** Building officials perform plan check reviews on equipment location, check recirculation system design, and verify that the building adheres to the performance budget or is designed according to prescriptive standards.
- **Construction Phase:** Plumbing contractors install the central HPWH system including the heat pump, storage tanks, plumbing components, and specialties including mixing valves and control sensors—as designed and per manufacturer instructions.
- **Inspection Phase:** Plumbing contractors populate LMCI/NRCI forms and schedule on-site verifications.

Field Verification and Diagnostic Testing/Acceptance Testing

The measure does not include field verification or testing.

Addressing Energy Equity and Environmental Justice

The Statewide CASE Team assessed the potential impacts of the proposed measure on DIPs utilizing data from the [CalEnviroScreen website](#) indicating how DIPs may be disproportionately affected, as well as studies showing how DIPs may be more susceptible to health and quality of life impacts, including [The Greenling Institute: Equitable Building Electrification](#) and other studies.

As a result of this measure, the Statewide CASE Team determined that DIP's DIPs benefit in the following ways:

- HPWHs are being utilized more and more often in affordable multifamily housing. As discussed in Sections 7.2 and [7.3](#), this measure has the potential for significant energy savings, which would directly benefit DIPs that utilize multifamily and affordable housing.

- The proposed measure would result in reduced on-site electricity and energy costs, and possibly result in lower maintenance costs, which would provide a higher benefit to people in low-income households and low-income census tracts who spend a higher percentage of their income than the average household on energy and rent.

Full details addressing energy, equity, and environmental justice can be found in Section 7.6 of this report.

Individual HPWH Ventilation

Proposal Description

This proposal suggests adding mandatory requirements to provide adequate ventilation for integrated HPWHs.

Proposed Code Change

This measure would include the following code changes:

- Add and adjust existing definitions in Section 100.1(b) to better differentiate HPWH types, so that the proposed ventilation air requirements do not impact HPWHs that do not need ventilation air.
- Add a “Heat pump water heater” section to the end of Section 110.3(c)l.
 - Language is based on ventilation air for gas appliances requirements from the California Plumbing and Mechanical codes.
 - Proposed code change provides for four basic HPWH ventilation paths:
 1. Large unvented room/closet.
 - Minimum room volume of 100 ft³ / kBtu/h of compressor capacity, or manufacturer specified requirements.
 2. Small vented room/closet.
 - Minimum room volume of 20 ft³ / kBtu/h of compressor capacity, or manufacturer specified requirements.
 - Larger of 125 in² net free area (NFA) plus 25 in² per kBtu/h of compressor capacity, or manufacturer specified requirements.
 3. Directly ducted to the HPWH inlet or outlet in any size room/closet.
 - With the addition of basic requirements like insulating the exhaust ducting and sealing duct joints with mastic.

4. Ventilation methods approved by the manufacturer and included in the permit application for approval from the building department.
 - o Proposed code prohibits using outdoor air for ventilation air without backup heat if compressor cutout is above the Winter Median of Extremes in JA2.2, Table 2-3.

Justification

With federal, state, local, and utility incentive programs, and a cultural drive towards reducing carbon emissions, the market for HPWHs in California has increased significantly over the last few years. Water heating accounts for 40 percent of natural gas consumption in the residential sector, representing 7 percent of the state's total GHG emissions (E3 2019). Water heating energy use in multifamily buildings can account for 27 to 32 percent of total energy use based on 2015 Residential Energy Consumption Survey by U.S. EIA. In 2022, Governor Gavin Newsom announced plans to expand California's climate change programs through CARB and the CEC, with goals to install six million heat pumps (including HPWHs) by 2030 (Newsom 2022). This is in addition to other simultaneous efforts at the state and federal level to limit or eliminate the sale of gas-fired water heaters, including:

- CPUC decision to eliminate natural gas line subsidies, effective July 2023 (CPUC 2022).
- CARB adopted plans to ban gas-fired water heaters by 2030 (CARB 2022).
- The U.S. DOE released a Technical Support Document showing clear Cost-Effectiveness for HPWHs (U.S. DOE, EERE 2022). Based on this document and an industry proposal (ACEEE, et al. 2022), a notice of proposed rulemaking is expected in 2023 that would increase the stringency of consumer water heater efficiency requirements, supporting transition to HPWHs, especially from electric resistance storage water heaters.

All these regulatory and political factors indicate a significant increase in the rate of adoption for HPWHs in the coming years.

Under 2019 Title 24, Part 6, HPWHs were the low-rise residential (both single family and multifamily buildings three habitable stories or less) DHW baseline when the proposed system is a heat pump or electric resistance system serving individual dwelling units or serving multiple dwelling units with no hot water recirculating loops. Under 2022 Title 24, Part 6, prescriptive requirements for HPWHs were added to Section 170.2. With the prescriptive approach a NEEA Tier-III rated HPWH is required (most HPWHs on the market meet or exceed NEEA Tier-III requirements). Under the performance approach, the U.S. DOE minimum efficiencies are used as the standard design baseline.

Several recent field studies and laboratory testing have reported degraded HPWH efficiency when they are installed in confined spaces without adequate ventilation, especially in exterior closets common to many multifamily building applications. The operational efficiency of any HPWH installed in such conditions, including those that are NEEA Tier-III and higher, would be lower than what is assumed in current Title 24 efficiency calculations. This reduction in efficiency is due both to the impact of lower evaporator temperature as well as the increased likelihood of second state electric heating.

This proposal provides for four methods to install HPWHs with adequate ventilation that would better assure the unit would perform as expected and protect the investment for the occupant and building owner. The proposal includes minimum requirements for these ventilation methods.

Background Information

HPWHs require a consistent thermal resource with adequate air volume or ventilation to reject heat. Efficient operation is achieved when the HPWH relies primarily on compressor-based heating, rather than electric resistance element(s), which serve as second stage or backup heating. A consistent thermal resource can be provided by installing in a large space, by venting to other spaces through grilles and louvered doors, or by ducting the HPWHs directly to another space.

Laboratory and field¹ testing have shown that in cramped closets without adequate ventilation, the operational efficiency of a HPWH would be lower than what is assumed in current Title 24 compliance software calculations. Based on findings from extensive lab testing completed by NEEA, Larson Energy Research, and PG&E Code Readiness (see 0), inadequate HPWH ventilation was found to degrade COP by 18 – 57 percent in small closets and cause excessive electric resistance backup heat use. The Statewide CASE Team proposes to include HPWH ventilation requirements in the 2025 Energy Code that would better assure that the unit would perform at acceptable levels.

Scope of Code Change Proposal

Table 10 summarizes the scope of the proposed changes and which sections of standards, Reference Appendices, Alternative Calculation Manual (ACM) Reference Manuals, and compliance documents that would be modified as a result of the proposed change(s).

¹ For example: “Evaluation of Unitary Heat Pump Water Heaters with Load-Shifting Controls in a Shared Multi-Family Configuration.” Hoeschele and Haile. (2022). <https://www.etcc-ca.com/reports/evaluation-unitary-heat-pump-water-heaters-load-shifting-controls-shared-multi-family>

Table 10: Scope of Code Change Proposal – Individual HPWH Ventilation

Type of Requirement	Mandatory
Applicable Climate Zones	All
Modified Section(s) of Title 24, Part 6	Sections 100.1(b), 110.3(c)
Modified Title 24, Part 6 Appendices	No
Would Compliance Software Be Modified	Yes
Modified Compliance Document(s)	<p>Adds reference to mandatory ventilation requirements in the following forms:</p> <ul style="list-style-type: none"> • 2022-LMCC-PLB-01-E • 2022-LMCI-PLB-E • 2022-LMCI-PLB-01-E • 2022-LMCI-PLB-02-E • 2022-LMCI-PLB-21-H • 2022-LMCI-PLB-22-H • 2022-LMCV-PLB-21-H • 2022-LMCV-PLB-22-H • 2022-NRCC-PLB-E • 2022-NRCI-PLB-E • 2022-NRCV-PLB-21-H • 2022-NRCV-PLB-22-H • 2022-CF1R-ADD-01-E • 2022-CF1R-ALT-01-E • 2022-CF1R-NCB-01-E • 2022-CF1R-ADD-02-E • 2022-CF1R-ALT-05-E • 2022-CF2R-ADD-02-E • 2022-CF2R-ALT-05-E • 2022 CF2R-PLB-02-E • 2022 CF2R-PLB-22-H • 2022 CF3R-PLB-22-H

Market Analysis and Regulatory Assessment

The Statewide CASE Team performed a market analysis with the goals of identifying current technology availability, current product availability, and market trends. It then considered how the proposed standard may impact the market in general as well as individual market actors. The Statewide CASE Team also gathered information about the incremental cost of complying with the proposed measure. Estimates of market size and measure applicability were identified through research and outreach with stakeholders including utility program staff, CEC staff, and a wide range of industry actors. In addition to conducting personalized outreach, the Statewide CASE Team

discussed the current market structure and potential market barriers during a public stakeholder meeting that the Statewide CASE Team held on February 17, 2023.

The main market actors include building owners/developers, design engineers, architects, contractors, equipment manufacturers, and energy consultants. In addition to traditional market actors, because central HPWH is a growing market, state and local government bodies and agencies with regulatory and program activities play an important role in the direction, pace, and rules around central HPWH adoption. These market actors include IOUs, program implementers: Community choice aggregators and municipal utilities, researchers, state regulatory agencies and local governments.

In the current market for consumer integrated HPWHs, there are 103 models certified by the CEC and listed in the MAEDBS, and there are 215 models certified by ENERGY STAR. All these integrated HPWHs use R-134a refrigerant, which has a GWP of 1430 and places the compressor cutout (the temperature below which the compressor stops running and the unit switches to backup heat) at around 40°F evaporator inlet air temperature. This impacts HPWH performance when using outdoor air for ventilation, which the Statewide CASE Team considered in their analysis. All models listed in the MAEDBS and ENERGY STAR, and currently available for sale in California, can be ducted, and all manufacturers have minimum ventilation requirements, which were considered while developing this proposal.

The top three manufacturers with the most certified units (with their subsidiary brand names) make up all but one of the units listed in the MAEDBS, and that one unit is not currently available for sale.

Options from manufacturers for providing adequate ventilation vary slightly by manufacturer, but all provide the same basic ventilation pathways:

- Install in a large space (encompassing 450 to 700 ft³ minimum).
- Install in a smaller space, but ensuring free air exchange using louvered doors, ventilation grilles, and door undercuts to net a large free area (approx. 240 in² minimum).
- Install in any size space, with ducting.

Regardless of the ventilation path used, following these requirements from manufacturers involves more than simply specifying equipment. Designers need to consider the location of the HPWH and provide additional detail in building design about how that ventilation is provided. It is important that this is done in the design, as different contractors (e.g., plumbers and HVAC) may be involved in different components of the installation and at different times.

The Statewide CASE Team compiled a list of recently constructed multifamily buildings with HPWH systems to understand current HPWH design practice and the application

trends. For project data, the Statewide CASE Team collected information from review of design drawings and specifications from various data sources.

The Statewide CASE Team does not anticipate significant employment or financial impacts to any sector of the California economy. This is not to say that the proposed change would not have modest impacts on employment in California. Refer to Section 8.2.4 for details.

Cost-Effectiveness

Energy cost savings were calculated by applying the LSC hourly factors to the energy savings estimates that were derived using the methodology described in Section 8.3.1. LSC hourly factors are a normalized metric to calculate energy cost savings that accounts for the variable cost of electricity and natural gas for each hour of the year, along with how costs are expected to change over the period of analysis. The CEC requested LSC savings over the 30-year period of analysis in both 2026 PV\$ and nominal dollars. The cost-effectiveness analysis uses LSC values in 2026 PV\$. Costs and Cost-Effectiveness using and 2026 PV\$ are presented in Section 8.4 of this report. The CEC uses results in nominal dollars to complete the Economic and Fiscal Impacts Statement (From 399) for the entire package of proposed change to Title 24, Part 6. Appendix G: Energy Cost Savings in Nominal Dollars presents LSC savings results in nominal dollars.

The proposed code change applies to all occupancies whenever a consumer integrated HPWH is installed, including in additions and alterations. LSC savings are the same for new construction and additions/alterations.

There are several options for providing ventilation for HPWHs that are very different from a technical and cost standpoint. For the purpose of calculating Cost-Effectiveness, the Statewide CASE Team chose to use the most universally applicable ventilation method to both new construction and additions/alterations, which also has the lowest incremental cost: grilles. This carries an incremental first cost of \$177.50 for all prototypes and for both new construction/additions and alterations and there are no costs for maintenance or replacement in the 30-year analysis period.

According to the CEC's definitions, a measure is cost effective if the B/C ratio is greater than 1.0. The B/C ratio is calculated by dividing the cost benefits realized over 30 years by the total incremental costs, which includes maintenance costs for 30 years. The B/C ratio was calculated using 2026 PV costs and cost savings.

Benefit to cost ratio for this measure over the entire 30-year analysis period ranges from 16.2 to 49.5, depending on the prototype and climate zone.

Statewide Energy Impacts: Energy, Water, and Greenhouse Gas (GHG) Emissions Impacts

The Statewide CASE Team calculated the first-year statewide savings for new construction and additions by multiplying the per-unit savings, which are presented in Section 8.3.2, by assumptions about the percentage of newly constructed buildings that would be impacted by the proposed code. The statewide new construction forecast for 2026 is presented in Appendix A, as are the Statewide CASE Team's assumptions about the percentage of new construction that would be impacted by the proposal (by climate zone and building type).

The first-year energy impacts represent the first-year annual savings from all buildings that were completed in 2026. The 30-year energy cost savings represent the energy cost savings over the entire 30-year analysis period. The statewide savings estimates do not take naturally occurring market adoption or compliance rates into account. First year electricity savings totaled 4.92 GWh with a peak electrical demand reduction of 0.37 MW. First year source energy savings totaled 7.6 million kBtu.

The Statewide CASE Team also calculated avoided GHG emissions associated with energy consumption using the hourly GHG emissions factors that the CEC developed along with the 2025 LSC hourly factors and an assumed cost of \$123.15 per metric tons of carbon dioxide equivalent emissions (metric tons CO₂e). During the first year, GHG emissions of 391 metric tons CO₂e would be avoided.

Table 11: Summary of Impacts for Individual HPWH Ventilation

Category	Metric	New Construction & Additions	Alterations
Cost-Effectiveness	Benefit-to-Cost Ratio Range (varies by climate zone and building type)	17.09 - 51.97	17.09 - 51.97
Statewide Impacts	First-Year Electricity Savings (GWh)	4.09	0.85
	First-Year Peak Electrical Demand Reduction (MW)	0.30	0.06
	First-Year Natural Gas Savings (Million Therms)	-	-
	First-Year Source Energy Savings (Million kBtu)	6.31	1.30
	30-Year LSC Electricity Savings from Buildings Constructed in First Year Code is in Effect (Million 2026 PV\$)	26.68	5.54
	30-Year LSC Natural Gas Savings from Buildings Constructed in First Year Code is in Effect (Million 2026 PV\$)	-	-
	30-Year Total LSC Savings from Buildings Constructed in First Year Code is in Effect (Million 2026 PV\$)	26.68	5.54
	First-Year Avoided GHG Emissions (Metric Tons CO2e)	324.16	67.13
	Monetary Value of Avoided GHG Emissions during First Year (\$)	39,919.29	8,267.14
	First-Year On-site Indoor Water Savings (Gallons)	-	-
	First-Year On-site Outdoor Water Savings (Gallons)	-	-
	First-Year Embedded Electricity in Water Savings (kWh)	-	-
Per Dwelling Unit Impacts	Annual Electricity Savings (kWh)	795.69	753.53
	Annual Peak Electrical Demand Reduction (W)	58.80	56.75
	Annual Natural Gas Savings (kBtu)	-	-
	Annual Source Energy Savings (kBtu)	1,228.06	1,160.50
	30-Year LSC Savings (2026 PV\$)	5,193.06	4,934.10
	Annual Avoided GHG Emissions (kg CO2e)	63.09	59.77
	Annual On-site Indoor Water Savings (Gallons)	-	-
	Annual On-site Outdoor Water Savings (Gallons)	-	-
	Annual Embedded Electricity in Water Savings (kWh)	-	-

Compliance and Enforcement

Overview of Compliance Process

The compliance process is described in Section 8.1.5. Impacts that the proposed measure would have on market actors are described in 8.5. The Statewide CASE Team

worked with stakeholders to develop a recommended compliance and enforcement process and to identify the impacts this process would have on various market actors.

The key issues related to compliance and enforcement are summarized below:

- **Design Phase:** Designers specify HPWH equipment and design according to engineering analysis and manufacturer guidelines.
- **Permit Application Phase:** Building officials perform plan check reviews on equipment location, check system design, and verify that the building adheres to mandatory requirements.
- **Construction Phase:** Contractors install the HPWH as designed and per manufacturer instructions.
- **Inspection Phase:** Compliance forms are completed, and on-site verifications are conducted.

Field Verification and Diagnostic Testing/Acceptance Testing

The measure does not include field verification or testing.

Addressing Energy Equity and Environmental Justice

As a result of this measure, the Statewide CASE Team determined that DIPs would benefit in the following ways:

- HPWHs are being utilized more and more often in affordable multifamily housing. This measure has the potential for significant energy savings, which would directly benefit DIPs that utilize multifamily and affordable housing.
- The proposed measure would result in reduced on-site electricity and energy costs, and possibly result in lower maintenance costs, which would provide a higher benefit to people in low-income households and low-income census tracts who spend a higher percentage of their income than the average household on energy and rent.

Full details addressing energy, equity, and environmental justice can be found in Section 8.6 of this report.

Individual DHW Electric Ready Clean-up

Proposal Description

This measure would clean up and add to the existing mandatory electric ready requirements of Title 24, Part 6 Section 160.4 for all new construction multifamily buildings constructed with gas or propane individual water heaters, to increase technical and financial feasibility of future retrofits to HPWH. The Statewide CASE Team is also

proposing a minor improvement to the single family code language as described in the Proposed Code Change section below.

Proposed Code Change

This measure would clean up and add to the existing mandatory requirements of Title 24, Part 6 Section 160.4 for all new construction multifamily buildings constructed with gas or propane individual water heaters. This measure moves the language to section 160.9, which is the multifamily mandatory requirements for electric ready buildings section, and adds or updates the following electric ready requirements:

- Electrical system components including the building main service entrance conduit, meter panel, main service disconnect, and main distribution panel must be sized and installed to accommodate the future HPWH.
- The branch conductor size requirement is updated from requiring “a 120/240-volt 3 conductor, 10 AWG branch circuit” to requiring a 120/240-volt 3 conductor branch circuit rated to 30 amps.
- Adequate physical space to accommodate the future HPWH.
- Adequate planning to meet the future HPWH ventilation needs, by reserving a future HPWH location with adequate volume as defined by the proposed code language, installing fixed openings, or by planning for future ducting to serve the HPWH.

Based on the findings from the multifamily research and stakeholder feedback, the Statewide CASE Team also proposes to improve the single family code language in Section 150.0(n). The Statewide CASE Team proposes to update the branch conductor size requirement, when the future HPWH would be within 3 feet from the water heater, from requiring “a 120/240-volt 3 conductor, 10 AWG branch circuit” to requiring a 120/240-volt 3 conductor branch circuit rated to 30 amps minimum.

Justification

With federal, state, local, and utility incentive programs, and a cultural drive towards reducing carbon emissions, the market for HPWHs in California has increased significantly over the last few years. As market adoption of HPWH continues to increase, it is important that California ensures building owners of new construction multifamily buildings with gas or propane water heating equipment are enabled to easily adopt HPWHs in future retrofits. This is especially important since HPWHs can be two to three times more energy efficient than a fossil-gas or electric-resistance water heating system. This proposal is intended to make future retrofits from gas or propane individual water heaters to individual HPWH more technically and financially feasible.

Background Information

At the state level, 2022 Title 24 Part 6 has existing electric ready requirements for gas or propane uses including heat pump electric ready, cooktop electric ready, clothes drying electric ready, and individual water heating electric ready in multifamily buildings. The heat pump electric ready, cooktop electric ready, and clothes drying electric ready requirements are included in Section 160.9. The individual HPWH electric ready requirements are included in section 160.4. The individual HPWH electric ready requirements, which this proposal would improve, were adopted in the 2022 code cycle.

As of December 2022, at least 70 jurisdictions across California have adopted electric readiness and all-electric construction reach codes during the 2019 code cycle. Most of these jurisdictions require all-electric construction with no exception for water heating specifically. California utilities also offer incentives for all-electric new construction in multifamily developments. With programs such as these encouraging the adoption of all-electric homes including heat pump technology, developers are receiving design assistance support to learn how to design buildings with code compliant heat pumps and standardize the design practice.

Scope of Code Change Proposal

Table 12 summarizes the scope of the proposed changes and which sections of standards, Reference Appendices, Alternative Calculation Manual (ACM) Reference Manuals, and compliance documents would be modified because of the proposed changes.

Table 12: Scope of Code Change Proposal - Individual DHW Electric Ready Clean-up

Type of Requirement	Mandatory
Applicable Climate Zones	All
Modified Section(s) of Title 24, Part 6	Section 150.0(n), 160.4(a), 160.9(d,f)
Modified Title 24, Part 6 Appendices	No
Would Compliance Software Be Modified	No
Modified Compliance Document(s)	<ul style="list-style-type: none">• 2022-LMCC-PLB-E: Domestic Water Heating• 2022-NRCC-PLB-E: Domestic Water Heating• 2022-LMCI-PLB-E: Domestic Water Heating• 2022-NRCI-PLB-E: Domestic Water Heating

Market Analysis and Regulatory Assessment

The Statewide CASE Team performed a market analysis with the goals of identifying current technology availability, current product availability, and market trends. It then considered how the proposed standard may impact the market in general as well as

individual market actors. Information was gathered about the incremental cost of complying with the proposed measure. Estimates of market size and measure applicability were identified through research and outreach with stakeholders including utility program staff and a wide range of industry actors. In addition to conducting personalized outreach, the Statewide CASE Team discussed the current market structure and potential market barriers during a public stakeholder meeting that the Statewide CASE Team held on February 17, 2023. The main market actors include building owners/developers, design engineers and contractors.

The Statewide CASE Team identified ventilation, space, electrical, and condensate drainage as the most critical components that affect technical feasibility of the proposal. Structural impacts were not deemed to affect technical feasibility in most retrofit to individual HPWH applications. The current electric ready code already requires adequate condensate drainage and planning for the future electrical load, so the Statewide CASE Team focused on adding ventilation and space requirements and improving the language regarding electrical requirements to explicitly align with standard practice of sizing the entire building system for the future electrical load.

This proposal builds on the existing state building code (Title 24, Part 6). The Statewide CASE Team is not aware of incompatibility with any local laws. As described in section 9.1.2.2, many jurisdictions have adopted local all electric code requirements that exceed the proposed electric ready requirements. These local codes should have a positive impact on the proposal by increasing market awareness of what infrastructure is required for all electric heat pump water heating equipment.

The Statewide CASE Team does not anticipate significant economic impacts, though the Team does expect to see a moderate increase in jobs as a result of this proposal. The Statewide CASE Team anticipates roughly 50 jobs created in the California Residential Construction Sector, about 34 jobs in the Building Design and Energy Consulting Sectors, and potentially 3-4 jobs for California Building Inspectors. Refer to Section 9.2.4 for details.

Cost-Effectiveness

While this measure will not save energy, the Statewide Case Team determined it to be cost effective based on a net present value calculation. The net present value calculation was performed based on a discount rate of 3 percent and retrofit to HPWH on burnout of the original gas or propane equipment which was conservatively estimated to be at 20 years. Based on these calculations the Team found the proposed electric ready measure to be cost effective as the measure would save \$542 in net present value dollars per dwelling unit. As a result, over time this proposal would leave more money available for discretionary and investment purposes once the initial cost is paid off.

Statewide Energy Impacts: Energy, Water, and Greenhouse Gas (GHG) Emissions Impacts

As this measure is simply a means of getting buildings electric ready for future DHW replacements, The Statewide CASE Team does not expect immediate energy, water or GHG impacts. However, the Statewide CASE Team does anticipate that the measure would accelerate the adoption of HPWH by lowering the cost barrier at replacement, thereby reducing GHGs over time.

Compliance and Enforcement

Overview of Compliance Process

The compliance process is described in Section 9.1.5. Impacts that the proposed measure would have on market actors are described in Section 9.2. The Statewide CASE Team worked with stakeholders to develop a recommended compliance and enforcement process and to identify the impacts this process would have on various market actors.

The key issues related to compliance and enforcement are summarized below:

- **Design Phase:** The plumbing engineer designs the plumbing systems and coordinates requirements to the rest of the design team. Currently, California Energy Code requires the electrical engineer to plan for a 10 AWG branch circuit to the future HPWH, but the electrical engineer is not explicitly required to size all upstream systems for the future load.
- **Permit Application Phase:** Plan checkers currently perform plan check reviews of the gas water heater systems and verify that the construction drawings meet the current individual HPWH electric ready requirements.
- **Construction Phase:** General contractors are responsible for construction of the building, including hiring specialized subcontractors as required. Based on the new proposal, the general contractor's responsibilities would now include installing an appropriately sized closet and ensuring that the specified ventilation requirements are met.
- **Inspection Phase:** The inspector typically reviews the applicable compliance forms and verifies that the individual gas water heater meets all applicable building codes, including the existing electric ready requirements.

Field Verification and Diagnostic Testing/Acceptance Testing

The measure does not include field verification or testing.

Addressing Energy Equity and Environmental Justice

The Statewide CASE Team assessed the potential impacts of the proposed measure on DIPs utilizing data from the [CalEnviroScreen website](#) indicating how DIPs may be disproportionately affected, as well as studies showing how DIPs may be more susceptible to health and quality of life impacts, including [The Greenlining Institute: Equitable Building Electrification](#) and other studies.

The proposed measure would benefit DIPs in the following ways:

- **Health Impacts.** Homes in disadvantaged communities (DACs) are more likely to be in areas with high levels of ambient pollution, and multifamily units have the additional IAQ concern of pollutant transfer from neighboring units. Several of the potential negative health impacts from buildings on DIPs are addressed by energy efficiency (R. A. Norton 2014., R. J. Cluett 2015, Rose 2020). For example, indoor air quality (IAQ) improvements through removal of combustion appliances can lessen the incidents of asthma, chronic obstructive pulmonary disease (COPD), and some heart problems.
- **Job creation.** [UCLA](#) and [UMass](#) both estimate job gains from building electrification would far outweigh job losses.

Full details addressing energy, equity, and environmental justice can be found in Section 9.6 of this report.

Central DHW Electric Ready

Proposal Description

This measure proposes mandatory electric ready requirements for all new construction multifamily buildings constructed with gas or propane central water heating equipment.

Proposed Code Change

This measure would include mandatory requirements for all new construction multifamily buildings constructed with gas or propane central water heating equipment to provide planning and infrastructure for future electric equipment. For the purposes of this measure, HPWH equipment includes the heat pump, storage tanks, and temperature maintenance tanks. This measure would require planning for the following electric ready components:

- Electrical system components including the building service entrance conduit, meter panel, main service disconnect, main distribution panel, and dedicated conduit from the panel to the planned location of the future HPWH. Equipment must be sized and installed to accommodate the future HPWH equipment.

- Installation of condensate drainage piping from the location of the future heat pump to an acceptable termination point, in accordance with the California Plumbing Code, to serve the future HPWH.
- Adequate physical space to accommodate the future HPWH equipment and required service clearance.
- Adequate planning to meet the future heat pump ventilation needs.

The measure includes two pathways for the new construction to comply with the proposed requirements: the design team can meet the electric ready requirements using code prescribed sizing factors, or the design team can meet the electric ready requirements by planning for a specific product if sufficient documentation of the design is provided.

Justification

With federal, state, local, and utility incentive programs, and a cultural drive towards reducing carbon emissions, the market for HPWHs in California has increased significantly over the last few years. As market adoption of HPWH continues to increase, it is important that California ensures building owners of new construction multifamily buildings with gas or propane water heating equipment are enabled to easily adopt HPWHs in future retrofits. This is especially important since HPWHs can be two to three times more energy efficient than a fossil-gas or electric-resistance water heating system. This proposal is intended to make future retrofits from gas or propane individual water heaters to individual HPWH more technically and financially feasible.

Background Information

The 2022 Title 24, Part 6 code has existing electric ready requirements for most gas uses such as space heating, cooking, clothes drying, and individual water heating in multifamily buildings. These requirements are included in Sections 160.9 and 160.4 respectively. Central gas water heaters do not currently have an electric ready requirement.

As of December 2022, at least 70 jurisdictions across California have adopted electric readiness and all-electric construction reach codes during the 2019 code cycle. Most of those jurisdictions require all-electric construction with no exception for water heating specifically. Some jurisdictions allow exceptions if a compliance pathway is not available under the 2022 Title 24, Part 6 code, and a builder is not able to meet the performance compliance standards using commercially available electric technology. California utilities also offer incentives for all-electric new construction in multifamily developments. With programs such as these encouraging the adoption of all-electric homes including heat pump technology, developers are receiving design assistance support to learn how to design buildings with code compliant heat pumps and standardize the design practice.

Scope of Code Change Proposal

Table 13 summarizes the scope of the proposed changes and which sections of standards, Reference Appendices, Alternative Calculation Manual (ACM) Reference Manuals, and compliance documents that would be modified as a result of the proposed change(s).

Table 13: Scope of Code Change Proposal - Central DHW Electric Ready

Type of Requirement	Mandatory
Applicable Climate Zones	All
Modified Section(s) of Title 24, Part 6	160.9
Modified Title 24, Part 6 Appendices	No
Would Compliance Software Be Modified	No
Modified Compliance Document(s)	<ul style="list-style-type: none"> • 2022-LMCC-PLB-E: Domestic Water Heating • 2022-NRCC-PLB-E: Domestic Water Heating • 2022-LMCI-PLB-E: Domestic Water Heating • 2022-NRCI-PLB-E: Domestic Water Heating

Market Analysis and Regulatory Assessment

The Statewide CASE Team performed a market analysis with the goals of identifying current technology availability, current product availability, and market trends. It then considered how the proposed standard may impact the market in general as well as individual market actors. Information was gathered about the incremental cost of complying with the proposed measure. Estimates of market size and measure applicability were identified through research and outreach with stakeholders including utility program staff and a wide range of industry actors. In addition to conducting personalized outreach, the Statewide CASE Team discussed the current market structure and potential market barriers during a public stakeholder meeting that the Statewide CASE Team held on February 17, 2023. The main market actors include building owners/developers, architects, design engineers and contractors.

Both interview and plan review results show that space, ventilation, and electrical requirements are the most critical components to address at the time of construction for future retrofitting of a central gas water heater system to a central HPWH system.

To quantitatively evaluate the impacts of retrofitting the gas water heating systems to HPWHs, the Statewide CASE Team worked with professional plumbing engineers and electrical engineers to develop a basis of design (BOD) for the four multifamily building prototypes. The BOD includes space, electrical, and plumbing requirements when replacing a central gas DHW system with solar thermal system with a central HPWH system.

This proposal does not require changes to other building codes, nor would it conflict with other code requirements.

The Statewide CASE Team does not anticipate significant economic impacts, though the Team does expect to see a moderate increase in jobs as a result of this proposal. The Statewide CASE Team anticipates roughly 82 jobs created in the California Residential Construction Sector, about 160 jobs in the Building Design and Energy Consulting Sectors, and potentially 16 jobs for California Building Inspectors. Refer to section 10.2.4 for details.

Cost-Effectiveness

While this measure will not save energy, the Statewide Case Team determined it to be cost effective based on a zero-dollar first cost as well as a net present value calculation. The calculation was performed over an assumed 20-year EUL for the equipment to be conservative, and the discount rate used was 3 percent. Based on these calculations the Team found the proposed electric ready measure to be cost effective as the measure would save \$1,051 in net present value dollars per dwelling unit in a high recovery system design for the low-rise loaded corridor prototype. As a result, over time this proposal would leave more money available for discretionary and investment purposes once the initial cost is paid off.

Statewide Energy Impacts: Energy, Water, and Greenhouse Gas (GHG) Emissions Impacts

As this measure is simply a means of getting buildings electric ready for future DHW replacements, The Statewide CASE Team does not expect energy, water, or GHG impacts.

Compliance and Enforcement

Overview of Compliance Process

The compliance process is described in Section 10.1.5. Impacts that the proposed measure would have on market actors are described in Section 10.2. The Statewide CASE Team worked with stakeholders to develop a recommended compliance and enforcement process and to identify the impacts this process would have on various market actors.

The key issues related to compliance and enforcement are summarized below:

- **Design Phase:** The plumbing engineer designs the plumbing systems including selecting the gas individual water heater, which triggers the proposed requirements. Current relevant activities include specifying the gas equipment, and determining and coordinating space requirements, electrical requirements,

and drainage piping locations to the rest of the design team. The design team then works to ensure the building design meets these criteria.

- **Permit Application Phase:** Plan checkers currently perform plan check reviews of the gas water heater systems and verify that the construction drawings meet code.
- **Construction Phase:** General contractors are responsible for construction of the building, including hiring specialized subcontractors as required. Based on the new proposal, the general contractor's responsibilities would now include coordinating with the construction team as needed to ensure the building is constructed adequately to meet the new electric-ready requirements. This would impact specialized subcontractors.
- **Inspection Phase:** The inspector typically reviews the applicable compliance forms and verifies that the individual gas water heater meets all applicable building codes, including the existing electric ready requirements.

Field Verification and Diagnostic Testing/Acceptance Testing

The measure does not include field verification or testing.

Addressing Energy Equity and Environmental Justice

The Statewide CASE Team assessed the potential impacts of the proposed measure on DIPs utilizing data from the [CalEnviroScreen website](#) indicating how DIPs may be disproportionately affected, as well as studies showing how DIPs may be more susceptible to health and quality of life impacts, including [The Greenlining Institute: Equitable Building Electrification](#) and other studies.

The proposed measure would benefit DIPs in the following ways:

- **Health Impacts.** Homes in disadvantaged communities (DACs) are more likely to be in areas with high levels of ambient pollution, and multifamily units have the additional IAQ concern of pollutant transfer from neighboring units. Several of the potential negative health impacts from buildings on DIPs are addressed by energy efficiency (R. A. Norton 2014., R. J. Cluett 2015, Rose 2020). For example, indoor air quality (IAQ) improvements through removal of combustion appliances can lessen the incidents of asthma, chronic obstructive pulmonary disease (COPD), and some heart problems.
- **Job creation.** [UCLA](#) and [UMass](#) both estimate job gains from building electrification would far outweigh job losses.

Full details addressing energy, equity, and environmental justice can be found in Section 10.6 of this report.

1. Introduction

The Codes and Standards Enhancement (CASE) initiative presents recommendations to support the California Energy Commission's (CEC's) efforts to update California's Energy Code (Title 24, Part 6) to include new requirements or to upgrade existing requirements for various technologies. The three California Investor-Owned Utilities (IOUs)—Pacific Gas and Electric Company (PG&E), San Diego Gas and Electric, and Southern California Edison (SCE)—and two Publicly Owned Utilities—Los Angeles Department of Water and Power and Sacramento Municipal Utility District (SMUD) (herein referred to as the Statewide CASE Team when including the CASE Author)—sponsored this effort. The program's goal is to prepare and submit proposals that would result in cost-effective enhancements to improve energy efficiency and energy performance in California buildings. This report and the code change proposal presented herein are a part of the effort to develop technical and cost-effectiveness information for proposed requirements on building energy-efficient design practices and technologies.

The CEC is the state agency that has authority to adopt revisions to Title 24, Part 6. One of the ways the Statewide CASE Team participates in the CEC's code development process is by submitting code change proposals to the CEC for consideration. The CEC would evaluate proposals the Statewide CASE Team and other stakeholders submit and may revise or reject proposals. See [the CECs 2025 Title 24 website](#) for information about the rulemaking schedule and how to participate in the process.

The goal of this CASE Report is to present a code change proposal for multifamily domestic hot water (DHW) heat pump water heater (HPWH) and distribution systems central HPWH clean-up, individual HPWH ventilation, individual DHW electric ready, and central HPWH electric ready. The report contains pertinent information supporting the proposed code change.

When developing the code change proposal and associated technical information presented in this report, the Statewide CASE Team worked with many industry stakeholders including building officials, design consultants, manufacturers, builders, utility incentive program managers, Title 24 energy analysts, and others involved in the code compliance process. The Statewide CASE Team also got costs from a total of three contractors or design firms to support measure development. The proposal incorporates feedback received during a public stakeholder workshop that the Statewide CASE Team held on February 17, 2023.

The following is a summary of the contents of this report:

Section 2 – Addressing Energy Equity and Environmental Justice presents the potential impacts of proposed code changes on disproportionately impacted populations (DIPs), as well as a summary of research and engagement methods.

Sections 3 through 10 focus on the following topics or measures within this code change proposal:

- **Section 3 – CPC Appendix M Pipe Sizing**
- **Section 4 – Pipe Insulation Enhancement**
- **Section 5 – Thermostatic Balancing Valves**
- **Section 6 – Master Mixing Valves**
- **Section 7 – Central HPWH Clean-up**
- **Section 8 – Individual HPWH Ventilation**
- **Section 9 – Individual DHW Electric Ready**
- **Section 10 – Central DHW Electric Ready**

Sections 3 through 10 include the following subsections for each topic or measure:

1. **Section x.1: Measure Description** of this CASE Report provides a description of the measure and its background. This section also presents a detailed description of how this code change is accomplished in the various sections and documents that make up the Title 24, Part 6 Standards.
2. **Section x.2: Market Analysis** includes a review of the current market structure. Section x.2.2 describes the feasibility issues associated with the code change, including whether the proposed measure overlaps or conflicts with other portions of the building standards, such as fire, seismic, and other safety standards, and whether technical, compliance, or enforceability challenges exist.
3. **Section x.3: Energy Savings** presents the per-unit energy, demand reduction, and energy cost savings associated with the proposed code change. This section also describes the methodology that the Statewide CASE Team used to estimate per-unit energy, demand reduction, and energy cost savings.
4. **Section x.4: Cost and Cost-Effectiveness** presents the lifecycle cost and cost-effectiveness analysis. This includes a discussion of the materials and labor required to implement the measure and a quantification of the incremental cost. It also includes estimates of incremental maintenance costs, i.e., equipment lifetime and various periodic costs associated with replacement and maintenance during the period of analysis.
5. **Section x.5: Annual Statewide Impacts** presents the statewide energy savings and environmental impacts of the proposed code change for the first year after

the 2025 code takes effect. This includes the amount of energy that would be saved by California building owners and tenants and impacts (increases or reductions) on material with emphasis placed on any materials that are considered toxic. Statewide water consumption impacts are also reported in this section.

6. **Section x.6: Addressing Energy Equity and Environmental Justice** presents the potential impacts of proposed code changes on disproportionately impacted populations (DIPs), as well as a summary of research and engagement methods.

Section 11 – Proposed Revisions to Code Language concludes the report with specific recommendations with strikeout (deletions) and underlined (additions) language for the Standards, Reference Appendices, and Alternative Calculation Manual (ACM) Reference Manual. Generalized proposed revisions to sections are included for the Compliance Manual and compliance forms.

Section 12 – Bibliography presents the resources that the Statewide CASE Team used when developing this report.

Appendix A: Statewide Savings Methodology presents the methodology and assumptions used to calculate statewide energy impacts.

Appendix B: Embedded Electricity in Water Methodology presents the methodology and assumptions used to calculate the electricity embedded in water use (e.g., electricity used to draw, move, or treat water) and the energy savings resulting from reduced water use.

Appendix C: California Building Energy Code Compliance Software Specification presents relevant proposed changes to the compliance software (if any).

Appendix D: Environmental Analysis presents the methodologies and assumptions used to calculate impacts on GHG emissions and water use and quality.

Appendix E: Discussion of Impacts of Compliance Process on Market Actors presents how the recommended compliance process could impact identified market actors.

Appendix F: Summary of Stakeholder Engagement documents the efforts made to engage and collaborate with market actors and experts.

Appendix G: Energy Cost Savings in Nominal Dollars presents LSC savings over the period of analysis in nominal dollars.

Appendix H: Energy Impact Analysis Methodology Details presents additional details behind the methodology used to calculate energy impacts.

Appendix I: Prototypes and Basis of Design CPC Appendix A Pipe Sizing Methodology presents the prototype and basis of design information for the CPC Appendix A pipe sizing methodology used.

Appendix J: Prototypes and Basis of Design CPC Appendix M Pipe Sizing Methodology presents the prototype and basis of design information for the CPC Appendix M pipe sizing methodology used.

The California IOUs offers free energy code training, tools, and resources for those who need to understand and meet the requirements of Title 24, Part 6. The program recognizes that building codes are one of the most effective pathways to achieve energy savings and GHG reductions from buildings – and that well-informed industry professionals and consumers are key to making codes effective. With that in mind, the California IOUs provide tools and resources to help both those who enforce the code, as well as those who must follow it. Visit [EnergyCodeAce.com](https://www.energycodeace.com) to learn more and to access content, including a glossary of terms.

2. Addressing Energy Equity and Environmental Justice

2.1 General Equity Impacts

The Statewide CASE Team recognizes, acknowledges, and accounts for a history of prejudice and inequality in disproportionately impacted populations (DIPs) and the role this history plays in the environmental justice issues that persist today. While the term disadvantaged communities (DACs) is often used in the energy industry and state agencies, the Statewide CASE Team chose to use terminology that is more acceptable to and less stigmatizing for those it seeks to describe (DC Fiscal Policy Institute 2017). Similar to the California Public Utilities Commission (CPUC) definition, DIPs refer to the populations throughout California that “most suffer from a combination of economic, health, and environmental burdens. These burdens include poverty, high unemployment, air and water pollution, presence of hazardous wastes, as well as high incidence of asthma and heart disease” (CPUC n.d.). DIPs also incorporate race, class, and gender since these intersecting identity factors affect how people frame issues, interpret, and experience the world.²

Including impacted communities in the decision-making process, ensuring that the benefits and burdens of the energy sector are evenly distributed, and facing the unjust legacies of the past all serve as critical steps to achieving energy equity. Recognizing the importance of engaging DIPs and gathering their input to inform the code change process and proposed measures, the Statewide CASE Team is working to build relationships with community-based organizations (CBOs) to facilitate meaningful engagement. A participatory approach allows individuals to address problems, develop innovative ideas, and bring forth a different perspective. Please reach out to Jingjuan “Dove” Feng (jfeng@trccompanies.com) and Marissa Lerner (mlerner@energy-solution.com) for further engagement.

Energy equity and environmental justice (EEEJ) is a newly emphasized component of the Statewide CASE Team’s work and is an evolving dialogue within California and

² Environmental disparities have been shown to be associated with unequal harmful environmental exposure correlated with race/ethnicity, gender, and socioeconomic status. For example, chronic diseases, such as respiratory diseases, cardiovascular disease, and cancer, associated with environmental exposure have been shown to occur in higher rates in the LGBTQ+ population than in the cisgender, heterosexual population (Goldsmith and Bell 2021). Socioeconomic inequities, climate, energy, and other inequities are inextricably linked and often mutually reinforcing.

beyond.³ To minimize the risk of perpetuating inequity, code change proposals are being developed with intentional consideration of the unintended consequences of proposals on DIPs. The Statewide CASE Team identified these potential impacts via research and stakeholder input. While the listed potential impacts should be comprehensive, they may not yet be exhaustive. As the Statewide CASE Team continues to build relationships with community-based organizations (CBOs), these partnerships would inform and further improve the identification of potential impacts. The Statewide CASE Team is open to additional peer-reviewed studies that contribute to or challenge the information on this topic presented in this report. The Statewide CASE Team is currently continuing outreach with CBOs and EEEJ Partners and the results of that outreach, as well as a summary of the 2025 code cycle EEEJ activities would be documented in the 2025 EEEJ Summary Report.

This subsection describes the equity impacts of all residential building code change proposals. Section 2.2 describes the EEEJ considerations and anticipated impacts for each code change proposal specifically.

2.1.1 Procedural Equity and Stakeholder Engagement

As mentioned, representation from DIPs is crucial to considering factors and potential impacts that may otherwise be missed or misinterpreted. The Statewide CASE Team is committed to engaging with representatives from as many affected communities as possible. This code cycle, the Statewide CASE Team is focused on building relationships with CBOs and representatives of DIPs across California. To achieve this end, the Statewide CASE Team is prioritizing the following activities:

- Identification and outreach to relevant and interested CBOs.
- Holding a series of working group meetings to solicit feedback from CBOs on code change proposals.
- Developing a 2025 EEEJ Summary Report

In support of these efforts, the Statewide CASE Team is also working to secure funds to provide fair compensation to those who engage with the Statewide CASE Team. While the 2025 code cycle would come to an end, the Statewide CASE Team's EEEJ efforts would continue, as this is not an effort that can be "completed" in a single or even

³ The CEC defines energy equity as "the quality of being fair or just in the availability and distribution of energy programs" (CEC 2018). American Council for an Energy-Efficient Economy (ACEEE) defines energy equity as that which "aims to ensure that disadvantaged communities have equal access to clean energy and are not disproportionately affected by pollution. It requires the fair and just distribution of benefits in the energy system through intentional design of systems, technology, procedures and policies" (ACEEE n.d.). Title 7, Planning and Land Use, of the California Government Code defines environmental justice as "the fair treatment and meaningful involvement of people of all races, cultures, incomes, and national origins, with respect to the development, adoption, implementation, and enforcement of environmental laws, regulations, and policies" (State of California n.d.).

multiple code cycles. In future code cycles, the Statewide CASE Team is committed to furthering relationships with CBOs and inviting feedback on proposed code changes with a goal of engagement with these organizations representing DIPs throughout the code cycle. Several strategies for future code cycles are being considered, including:

- Creating an advisory board of trusted CBOs that may provide consistent feedback on code change proposals throughout the development process.
- Establishing a robust compensation structure that enables participation from CBOs and DIPs in the Statewide CASE Team’s code development process.
- Holding equity-focused stakeholder meetings to solicit feedback on code change proposals that seem more likely to have strong potential impacts.

2.1.2 Potential Impacts on DIPs in Single Family and Multifamily Buildings

2.1.2.1 Health Impacts

Understanding the influences that vary by demographics, location, or type of housing is critical to developing equitable code requirements. For example, as described in Section 2.2, homes in disadvantaged communities (DACs) are more likely to be in areas with high levels of ambient pollution, and multifamily units have the additional IAQ concern of pollutant transfer from neighboring units.

Several of the potential negative health impacts from buildings on DIPs are addressed by energy efficiency (R. A. Norton 2014., R. J. Cluett 2015, Rose 2020). For example, indoor air quality (IAQ) improvements through ventilation or removal of combustion appliances can lessen the incidents of asthma, chronic obstructive pulmonary disease (COPD), and some heart problems. Water heating and building shell improvements can lower stress levels associated with energy bills by lowering utility bill costs. Better insulation and tighter building envelopes can reduce the health impacts from intrusion of dampness and contaminants, as well as providing a measure of resilience during extreme conditions. Electrification can reduce the health consequences resulting from NO_x, SO₂, and PM_{2.5}.

2.1.2.2 Energy Efficiency and Energy Burden

Because low-income households have a higher energy burden (percent of income spent on energy) than average households, energy efficiency alone can benefit them more acutely compared to the average. Numerous studies have shown that low-income households spend a much higher proportion of their income on energy (two to five times) than the average household (Power 2007, Norton and Brown 2014, Rose and Hawkins 2020). See the energy cost savings sections in each measure section for an estimate of energy cost savings from the current proposals. Moreover, utility cost stability is typically more important to these households compared to average

households; for households living paycheck to paycheck, an unexpectedly high energy bill can keep that household cyclically impoverished (A. L. Dreihobl 2020). Energy burdened households are 175 to 200 percent more likely to remain impoverished for longer than households not experiencing energy burden (A. L. Dreihobl 2020). The impact of a rate increase or weather-related spike is more easily handled the greater the efficiency of the home. The cost impacts of efficiency and renewables can be significantly different for those in subsidized housing (where the total rent plus utilities is controlled) versus those in single family homes or market-rate multifamily buildings.

2.1.2.3 First Cost and Cost of New Construction

One potential negative consequence to DIPs of code-based efficiency improvements is the potential for increased housing costs. While some of the proposed code measures would decrease construction costs or have no impact on construction costs, others would increase construction costs. For those proposed code measures that would increase construction costs, this increase is likely to be small compared with total development and construction costs. However, a study found that increased construction costs do not have a statistically significant impact on home prices, as prices in the new home market are driven overwhelmingly by demand (Stone, Nickelsburg and Yu, New Home Cost v. Price Study 2018). According to a peer-reviewed study done for the California Tax Credit Allocation Committee (CTCAC), land costs and developer characteristics (size, experience, and profit structure of the firm) have the most significant effect on affordable housing costs (CTCAC 2014). The 2014 study echoes the same findings in CTCAC's cost study prepared in 1996 as well as the 2015 study by Stone et al. (Stone, Nickelsburg and Yu, Codes and Standards White Paper: Report - New Home Cost v. Price Study 2015). Similarly, developers of market-rate apartments conduct studies to investigate rent history and other information for comparable multifamily properties, which informs rent levels for specific projects⁴.

2.1.2.4 Cost Impacts for Renters

Renters within DIPs can also benefit from home energy efficiency improvements. Whether market rate or affordable, utility bills would be lower to the degree their homes are more energy efficient. However, the utility bill impacts of energy efficiency in subsidized affordable housing is less clear, since CTCAC staff regularly review tax credit properties to assure that affordable housing renters pay utility bills virtually equal to the utility cost estimates that were used when establishing rents (Internal Revenue Service, Treasury 2011). Renters of market-rate housing seldom ask about energy

⁴ As examples, Yardi-Matrix: <https://www.yardimatrix.com/Property-Types/Multifamily>, HCA: <https://apartmentstudy.gr8.com/>, and Foley & Puls: http://foleypuls.com/apartment_market_research.html conduct market studies.

efficiency and utility bills,⁵ so efficiency has little impact on rents, whereas it can have a large impact on utility bills (NMHC 2022).

2.2 Specific Impacts of the Proposal

The Statewide CASE Team examined how the proposed measures in this report might specifically impact DIPs. Details for measure-specific impacts can be found in Sections 3.6, 4.6, 5.6, 6.6, 7.6, 8.6, 9.6, and 10.6. Select examples of impacts include lower construction costs, lower energy costs, and improved hot water delivery performance.

2.2.1 Potentially Impacted Populations

- The following potentially impacted populations are potentially impacted by multiple proposed measures. Low-income Californians are 39 percent more likely to live in multifamily housing than the general population, and low-income multifamily residents would be uniquely impacted by proposed measures. This is because the proposals impact construction costs, energy costs, and hot water delivery performance to name a few.
- For projects with gas water heaters, multiple measures would result in slight reductions of gas energy use and associated combustion by-products. The reduction of combustion by-products would benefit multifamily residents that live in the areas identified by CalEnviroScreen as “DACs”, since these residents live in areas that are “disproportionately affected by environmental pollution and other hazards”, which include higher outdoor (ambient) PM2.5 and traffic (CALEPA 2022)

2.2.2 Potential Impacts

The Statewide CASE Team anticipates the following impacts to DIPs from multiple of the proposed measures:

2.2.2.1 Impacts on Construction Costs

Some of the measures would result in lower construction costs for new construction, while others would increase construction costs. These impacts on construction costs for new construction may be offset by higher rents or the purchase price of the dwelling units, putting a higher burden on low-income households and residents in low-income census tracts. If these cost savings are passed on to building occupants as lower rent or purchase price, there could be a positive impact on low-income households and residents in low-income census tracts. If these additional costs are passed on to

⁵ According to manager and renter surveys conducted by the Multi-Housing Council in 2022, residents are interested in internet connectivity, package delivery services, gyms, and similar amenities. Smart thermostats were the only energy related feature they reported as essential or nearly so.

building occupants as higher rent or purchase price, there could be a negative impact on low-income households and residents in low-income census tracts.

2.2.2.2 Reduction in Energy Costs

Most of the measures result in energy cost savings, which would provide a higher benefit to people in low-income households and low-income census tracts who spend a higher percentage of their income on energy than the general population.

2.2.2.3 Improved Hot Water Delivery Performance

Several of the measures result in improved hot water delivery performance, reducing excess water use and risk of waterborne pathogens which would provide a higher benefit to the people in low-income households and low-income census tracts who spend a higher percentage of their income on utilities than the general population and may have increased healthcare costs.

2.2.2.4 Increased Resilience

With electrification, buildings can be connected to microgrids with solar and wind generation and battery storage. This can be beneficial during periods of power outages and natural disasters. Most new gas appliances rely on electricity to operate, and natural gas systems can also be affected during natural disasters, therefore debunking the myth that gas appliances are more reliable in case of an outage. By combining building electrification with clean generation from a microgrid and backup storage, all-electric homes can continue to operate and provide power to life sustaining equipment during a grid outage. Also, methane gas is a major fire risk during an earthquake and can cause fires as documented in California's [2022 study](#).

Furthermore, as wealthier customers leave the gas grid, this could leave DIPs even more vulnerable to a failing and expensive gas grid as utilities must decide if they want to continue investing money in a system that is becoming obsolete and expensive to operate.

2.2.2.5 Improved Air Quality

Several of the measures would result in reduced on-site combustion of natural gas, either by increased efficiency of the domestic hot water system, or by reducing the barriers to future retrofit to HPWH. These reductions in natural gas use impact air quality and have unique health benefits for DIPs as described in detail in Section 2.1.2.1

3. CPC Appendix M Pipe Sizing

3.1 Measure Description

3.1.1 Proposed Code Change

This proposal recommends using pipe sizing methodology based on California Plumbing Code (CPC) Appendix M in lieu of the standard practice CPC Appendix A. Specifically, this measure would add a prescriptive requirement in Section 170.2(d) for sizing water pipes according to CPC Appendix M for central DHW systems in multifamily buildings. This measure would apply only to newly constructed multifamily buildings. The proposal would require minor updates to the compliance software. This measure would not add field verification or acceptance tests. Sizing water pipes according to CPC Appendix M is currently a compliance credit in California Building Energy Code Compliance (CBECC) 2022.

As a state agency with jurisdiction over multifamily buildings, the Department of Housing and Community Development (HCD) proposed to adopt UPC Appendix M into the CPC as part of 2022 Intervening Code Cycle. The California Building Standards Commission approved final adoption of UPC Appendix M on August 1, 2023. Next, UPC Appendix M will be published into CPC on January 1, 2024, and will be available for statewide use on a voluntary basis on July 1, 2024.

3.1.2 Justification and Background Information

3.1.2.1 Justification

Standard practice pipe sizing is based on CPC Appendix A. CPC Appendix A uses the water supply fixture units approach and is based on estimated demand curve chart, referred to as Hunter's curve, to estimate maximum water demand in each piping section and calculate pipe diameter for that section based on water velocity and pressure drop. Appendix A sizing uses outdated fixture flows and conservative flow diversity in pipes upstream of multiple fixtures.

CPC Appendix M contains a performance-based pipe sizing calculation procedure that accounts for California code-required, low-flow fixtures, and it uses a large dataset of flow diversity in real buildings to create a more accurate prediction of peak flow.

While CPC requirements do not apply to the heating plant piping, the practice of using Appendix M to reduce the maximum cold and hot water distribution flow rate requirements results in pipe diameter sizing reductions at the heating plant. The plant piping applicable to size reductions include piping between primary storage tanks, as well as the temperature maintenance tank and outlet to the master mixing valve (MMV).

The pipe sizing reductions at the heating plant leads to additional heat loss reductions of the wider hot water distribution system, which was not modeled in the last code cycle.

CPC Appendix M pipe sizing procedure results in smaller pipe sizes than standard practice sizing, which results in lower energy costs from reduced hot water distribution system and heating plant pipe heat losses due to reducing the pipe, fitting, and appurtenance surface area for which heat is lost to the ambient environment. CPC Appendix M procedure typically reduces distribution system first costs for the builder with lower material and labor savings because of reduced cold water, reclaimed water (if applicable), and hot water piping diameter in the distribution loop and heating plant. This includes reduced costs for cold-water equipment such as backflow preventers, pressure reducing valves, and booster pumps.

Appendix M typically results in smaller diameter cold, reclaimed water and hot water distribution, and heating plant piping than standard practice sizing. Smaller diameter piping results in lower project first costs for piping, fittings, appurtenances, and pipe insulation as well as reduced water and wastewater capacity charges in jurisdictions that charge a fee based on mains meter size.

The smaller pipe size would improve water quality in the piping due to shorter water dwell times (Steffi Becking, et al. 2023). It would result in faster hot water delivery times in non-recirculated sections, leading to water savings. It likely would result in a reduction in need of mains water meter in standalone multifamily buildings or mixed-use buildings where there are separate mains meters for irrigation, retail, and dwelling units. This would lead to lower building water utility monthly service charges and water and wastewater capacity charge savings for the builder in jurisdictions that base charges on the mains water meter size. The water savings and construction and operating savings from mains water meter size reduction are not quantified further in terms of measure cost savings for this measure.

3.1.2.2 Background Information

Appendix M was added to the UPC in 2018 and includes an alternative pipe sizing procedure. The Appendix M addition was the first major water pipe sizing update in 80 years. The Appendix M sizing methodology is being widely circulated and utilized among designers and is supported by IAPMO's WDC. The Appendix M pipe sizing procedure is included in the 2021 UPC and in Appendix C of the 2020 Water Efficiency and Sanitation Standard (WE-Stand).

The IAPMO WDC is a tool used to size pipes according to the CPC/UPC Appendix M (Buchberger, et al. 2017). The authors of this tool developed the sizing methodology in response to the increased prevalence of low-flow fixtures. The previous Hunter's curve/fixture units sizing method assumed outdated gallons per minute (GPM) rating for each fixture type (sink, water closet, shower, etc.), and used outdated data on diversity

of flow in pipes upstream of multiple fixtures. CPC Appendix M and the IAPMO WDC account for modern low-flow fixtures required in California code, and they use a large new dataset of flow diversity in real buildings to create a more accurate prediction of peak flow for pipe sizing.

Data published on actual peak flow rates in 16 multifamily buildings comparing UPC Appendix A and Appendix M estimations substantiate using Appendix M as the new baseline for cold and hot water pipe diameter sizing tool (Klein 2021) (Steffi Becking, et al. 2023).

Outside of California, the following jurisdictions have adopted UPC Appendix M into their plumbing code: Hawaii, Nevada, New Mexico, North Dakota, Oregon, and the City of Seattle and King County, Washington. Wisconsin has approved the WDC as an alternative standard. In California, Appendix M can only be used in Foster City, City of San Jose, City of Oakland, and County of Santa Cruz, which have adopted Appendix M in their municipal codes.

As a state agency with jurisdiction over multifamily buildings, HCD proposed to adopt UPC Appendix M into the CPC as part of 2022 Intervening Code Cycle. The California Building Standards Commission approved final adoption of UPC Appendix M on August 1, 2023. Next, UPC Appendix M will be published into CPC on January 1, 2024, and will be available for statewide use on a voluntary basis on July 1, 2024.

As a code change proposal, Appendix M originated within the Statewide CASE Team in the 2022 Title 24, Part 6 update cycle, and it was added as a compliance credit in CBECC 2022 because of Statewide CASE Team efforts. The 2022 Title 24, Part 6 Statewide CASE Team found that there is interest in using Appendix M for design calculations, but stakeholder conversations, designer interviews, and a review of the American Society of Plumbing Engineers (ASPE) Connect forum show there is limited market adoption (ASPE n.d.).

3.1.3 Summary of Proposed Changes to Code Documents

The sections below summarize how the standards, Reference Appendices, Alternative Calculation Method (ACM) Reference Manuals, and compliance forms would be modified by the proposed change.⁶ See Section 11 of this report for detailed proposed revisions to code language.

The prescriptive approach for water heating systems would incorporate code language requiring the use of CPC Appendix M for distribution systems serving individual and multiple dwelling units. The IAPMO Appendix M WDC could be integrated into CBECC

⁶ Visit [EnergyCodeAce.com](https://www.energycodeace.com) for trainings, tools, and resources to help people understand existing code requirements.

software to accept inputs and provide outputs for all calculated sections of pipe comprehensively, which would make it easier for building departments to review.

3.1.3.1 Specific Purpose and Necessity of Proposed Code Changes

Each proposed change to language in Title 24, Part 11 and Part 6 as well as the reference appendices to Part 6 are described below. See Section 11.2 of this report for marked-up code language.

Section: 170.2(d)

Specific Purpose: The specific purpose of this addition is to establish CPC Appendix M Pipe Sizing as a prescriptive requirement to improve and standardize hot water system pipe sizing.

Necessity: The addition is necessary to reduce hot water pipe heat losses to increase energy efficiency via cost-effective building design standards, as directed by California Public Resource Code Sections 25213 and 25402.

3.1.3.2 Specific Purpose and Necessity of Changes to the Nonresidential and Multifamily ACM Reference Manual

The purpose and necessity of proposed changes to the Nonresidential and Multifamily ACM Reference Manual are described below. See Section 11.4 of this report for the detailed proposed revisions to the text of the ACM Reference Manual.

Sections: 6.11 DHW

Specific Purpose: The specific purpose is to provide guidance on using CPC Appendix M Pipe Sizing as the standard design to reduce hot water distribution losses and update the dwelling unit distribution system subsection and central system distribution subsection.

Necessity: These changes are necessary to describe how the compliance software would account for pipe sizing using CPC Appendix M methodology and mention the energy compliance penalty if CPC Appendix A is used.

3.1.3.3 Summary of Changes to the Nonresidential and Multifamily Compliance Manual

Chapter 11.6 of the Nonresidential and Multifamily Compliance Manual would need to be revised. Specifically, it would require adding a summary of the measure to the “What’s New” section under 11.6.1.2. Additions to Section 11.6.4 Multifamily distribution systems would describe the change and impact on hot water systems serving individual dwelling units and multiple dwelling units. Additions to Section 11.6.6 Systems Serving Individual Units and Section 11.6.7 Systems Serving Multiple Dwelling Units would be

needed. Specifically in Subsection 11.6.6.3 and 11.6.7.2 and 11.6.7.6 Prescriptive Requirements would discuss the Appendix M pipe sizing requirement and in Subsection 11.6.6.4 and 11.6.7.3 and 11.6.7.7 Performance Approach would discuss the Appendix M compliance option and system multipliers.

3.1.3.4 Summary of Changes to Compliance Forms

The proposed code change would modify the compliance forms listed below.

- **2022-LMCC-PLB-E: Domestic Water Heating: Low-Rise Multifamily Certificate of Compliance Domestic Water Heating:** Adds a prescriptive requirement question on if the design team has selected Appendix A or Appendix M for distribution pipe sizing and documented it on the building plans.
- **2022-NRCC-PLB-E: Domestic Water Heating: Nonresidential Certificate of Compliance Domestic Water Heating:** Adds a prescriptive requirement question on if the design team has selected Appendix A or Appendix M for distribution pipe sizing and documented it on the building plans.
- **2022-LMCI-PLB-E: Domestic Water Heating: Low-Rise Multifamily Certificate of Inspection Domestic Water Heating:** Adds a prescriptive requirement question on if the construction team has installed distribution pipe sizing in accordance with Appendix A or Appendix M as specified on building plan documents.
- **2022-NRCI-PLB-E: Domestic Water Heating: Nonresidential Certificate of Inspection Domestic Water Heating:** Adds a prescriptive requirement question on if the construction team has installed distribution pipe sizing in accordance with Appendix A or Appendix M as specified on building plan documents.

3.1.4 Regulatory Context

CPC Appendix M Pipe Sizing has been adopted voluntarily by three jurisdictions:

- Foster City: Part of Ordinance 654, amendment to the 2022 California Building Standards (Foster City 2023).
 - Chapter 15.16 adoption of CPC Appendix M was included as part of the wider adoption of the 2018 Edition of the CPC.
- San Jose: Design team may choose one of three design paths (City of San Jose 2023).
 - Chapter 24.04.120 Adoption of CPC Appendix M was included as part of the wider adoption of the 2022 Edition of the CPC.
- Oakland: Municipal Code Section 15.04.3.5065 (City of Oakland 2023)
 - Ordinance to Adopt Appendix M of the 2022 CPC, California Code Of Regulations, Title 24, Part 5, Peak Water Demand Calculator.

- Santa Cruz: Title 12 Building Regulations Section 12.10.235 2022 (County of Santa Cruz 2022)
 - (C) Water Demand Calculator Amendment. Appendix M of the 2022 California Plumbing Code is hereby adopted.

These cities may have a compliance process that can provide guidance for the CEC, state agencies, and other jurisdictions on how to best implement this new pipe sizing option.

The proposed changes relate to existing state agency regulations including BSC, DSA, HCAI, and HCD. Each agency decides whether to adopt Appendix M for the buildings in their jurisdictions. If adopted, the CPC Matrix Adoption Table in the CPC would then be updated for guidance (non-regulatory) purposes for each state agency and building application. Based on final adoption by CBSC of the HCD proposal, the Matrix Adoption Table would be revised to allow for the use of CPC Appendix M for pipe sizing for residential applications.

3.1.4.1 Determination of Inconsistency or Incompatibility with Existing State Laws and Regulations

This proposal does not conflict with municipal code in Foster City, City of San Jose, City of Oakland, and County of Santa Cruz, which already adopted UPC Appendix M for pipe sizing as an alternative pipe sizing method. Moreover, the procedures developed in each of the municipalities to review pipe sizing methodology may provide an opportunity for the CEC to get insight into the existing implementation and review process.

This Title 24, Part 6 proposal does not conflict with the CPC in Title 24, Part 5 since CBSC approved CPC Appendix M adoption into the 2022 CPC during 2022 Intervening Code Cycle. Given that builders can simply choose to use the CPC Appendix M procedure starting July 1, 2024, the proposed prescriptive measure can proceed through CEC rulemaking process. If approved, the proposed prescriptive measure will come into effect on January 1, 2026.

3.1.4.2 Duplication or Conflicts with Federal Laws and Regulations

There are no relevant federal laws or regulations.

3.1.4.3 Difference From Existing Model Codes and Industry Standards

UPC is a model code developed by IAPMO to govern the installation and inspection of plumbing systems. The IAPMO WDC is a tool developed to size pipes according to the CPC/UPC Appendix M (Buchberger, et al. 2017). The proposed measure aligns with the model code and is enhanced by the WDC tool.

3.1.5 Compliance and Enforcement

When developing this proposal, the Statewide CASE Team considered methods to streamline the compliance and enforcement process and how negative impacts on market actors who are involved in the process could be mitigated or reduced. This section describes how to comply with the proposed code change. It also describes the compliance verification process. Section 3.2 presents how the proposed changes could impact various market actors.

The compliance verification activities related to this measure that need to occur during each phase of the project are described below:

- **Design Phase:** Plumbing designers would perform pipe sizing calculations and design tasks based on CPC Appendix M method. This method is like the existing Appendix A process, except the fixture unit calculation and use of Hunter's curve chart is substituted by the IAPMO WDC spreadsheet to calculate flow rate for each section of pipe. The rest of the pipe sizing process to determine the number of fixtures and size pipe diameter for each pipe section based on water velocity and pressure drop remains unchanged.
 - Plumbing designer would perform pipe sizing calculations and design based on CPC Appendix A method.
 - Energy consultant would assist building designer by providing energy compliance documentation required for CPC Appendix M pipe sizing.
 - Energy consultant would provide LMCC/NRCC compliance documentation.
- **Permit Application Phase:** Plumbing designers would provide design documentation. Designers would indicate on the compliance form which plumbing plan sheets include the IAPMO calculations. Building department plan inspector would need to understand and review Appendix M sizing reported in the LMCC/NRCC compliance form.
 - Compliance documents are submitted with the building permit application.
- **Construction Phase:** No compliance or enforcement changes are anticipated as the contractors would follow pipe sizing specified design documents as usual.
 - HERS Rater would complete acceptance testing prior to inspection.
- **Inspection Phase:** There would be no impact on inspection activities.
 - Certificate of Installation, LMCI/NRCI, would be completed by the installation contractor.
 - Authority having jurisdiction building department field inspector would perform field acceptance testing.

3.2 Market Analysis

The Statewide CASE Team performed a market analysis with the goals of identifying current technology availability, current product availability, and market trends. The Statewide CASE Team considered how the proposed standard may impact the market in general as well as individual market actors. The Statewide CASE Team gathered information about the incremental cost of complying with the proposed measure and estimated market size and measure applicability through research and outreach with stakeholders including designers, contractors, energy consultants, and building inspectors.

3.2.1 Current Market Structure

In addition to conducting personalized outreach, the Statewide CASE Team discussed the current market structure and potential market barriers during a public stakeholder meeting that the Statewide CASE Team held on February 17, 2023.

The Statewide CASE Team reviewed 50 multifamily project drawings and data from several new construction and retrofit programs, the CEC's [Electric Program Investment Charge](#) (EPIC) program field projects as well as the [Dodge Data & Analytics Database](#) to determine the pipe sizing methodology. The Statewide CASE Team's review indicated that Appendix A or 2019 CPC was used for pipe sizing, essentially all 25 project drawings that indicated pipe sizing methodology used Appendix A, and none used Appendix M. Interviews with two designers indicate that they use Appendix M for projects in municipalities in other states that allow it, but they have not used it yet in California.

A city senior building inspector from a municipality that allows Appendix M sizing stated anecdotally that only two multifamily projects out of all the projects submitted for plan review since municipal code adoption in 2022 used Appendix M sizing, suggesting a lack of awareness of the municipal code change and familiarity of the methodology. Another inspector from another municipality that permits Appendix M stated that they have not seen any Appendix M pipe sizing in the projects that they have inspected. These municipal codes are only a few years old, and it is likely designers and developers are not aware of the Appendix M option.

Plumbing materials supply and installation markets would not change for this measure, because the only change would be use of smaller pipe sizing in portions of the DHW heating plant piping and distribution system. Pipes used for DHW distribution are the same pipes used in HVAC systems and commercial and industrial facilities, so they are widely available through retail, online, and distributor distribution channels. Multifamily pipe sizes and quantities are a small portion of the overall hydronic and water distribution market, so changes in pipe size demands would not impact the supply chain. It may, in the long term, reduce piping material weight, further lowering purchase cost.

3.2.2 Technical Feasibility and Market Availability

The Statewide CASE Team determined that Appendix M Pipe Sizing is technically feasible for adoption as a prescriptive measure based on literature review, field monitored flowrate data, adoption into city municipal codes in California, adoption into city and state plumbing codes outside California, interviews with designers, support from a wide range of stakeholders, and other considerations.

This prescriptive measure is now feasible with the approved updates to the CPC in the Appendix M Matrix Adoption Table to show HCD adoption of Appendix M as an optional sizing method, which would be effective statewide on July 1, 2024.

3.2.2.1 Literature Review

The Statewide CASE Team reviewed several IAPMO publications and literature from many sources to assess technical feasibility and market availability, including:

IAPMO Publications:

- Peak Water Demand Study (Buchberger, et al. 2017)
- Water Demand Calculator User Guide (IAPMO 2019)
- Water Demand Calculator Study (Santec Architecture Inc. 2020)
- Material and Labor Cost Savings Potential Summary Report (Santec Architecture Inc. 2021)
- A Review of Connection Fees and Service Charges by Meter Size (Alliance for Water Efficiency 2021)
- Water Demand Calculator Version 2.1 (IAPMO 2022)

Other Sources:

- Alternative Methodology for Sizing Water Pipes (Steffi Becking, et al. 2023)
- Appendix M Fact Sheet (CalWEP 2021)
- Extending the Water Demand Calculator to Commercial and Institutional Buildings (Toritseju Omaghomi 2022)
- Factsheet on UPC Appendix M (C&S_Reach_Code 2022)
- IAPMO Applauds Passage of U.S. Federal Premise Plumbing Research Legislation (World Plumbing Council 2022)
- The Water Demand Calculator Leaves Home (PHCC-National Association 2021)
- UC Calculator Drives Water Efficiency in Homes (Pytel 2019)
- Water Sizing Example Thru Appendix A UPC (BG's Plumbing Class 2021)
- California Reach Code program report

3.2.2.2 Monitored Flowrate Data

In the 2022 CASE process, stakeholders asked if there is a risk of smaller pipe sizes not being able to meet peak hot water demand. The Statewide CASE Team believes the risk of under sizing is small based on the data and history behind Appendix M. A large portion of the field data used in the WDC for Appendix M was from field data in multifamily buildings (Buchberger, et al. 2017). More recent data, shown in Figure 1 below, compares the monitored data from 16 multifamily buildings to the peak water demand based on Appendix A and Appendix M sizing methodologies. The graph shows that Appendix M is a conservative approach compared to actual peak water flow in all buildings. This chart was part of a larger memorandum developed by Gary Klein that was submitted to the CBSC staff in 2021, which proposes Appendix M be adopted by state agencies during the 2022 CPC intervening code cycle.

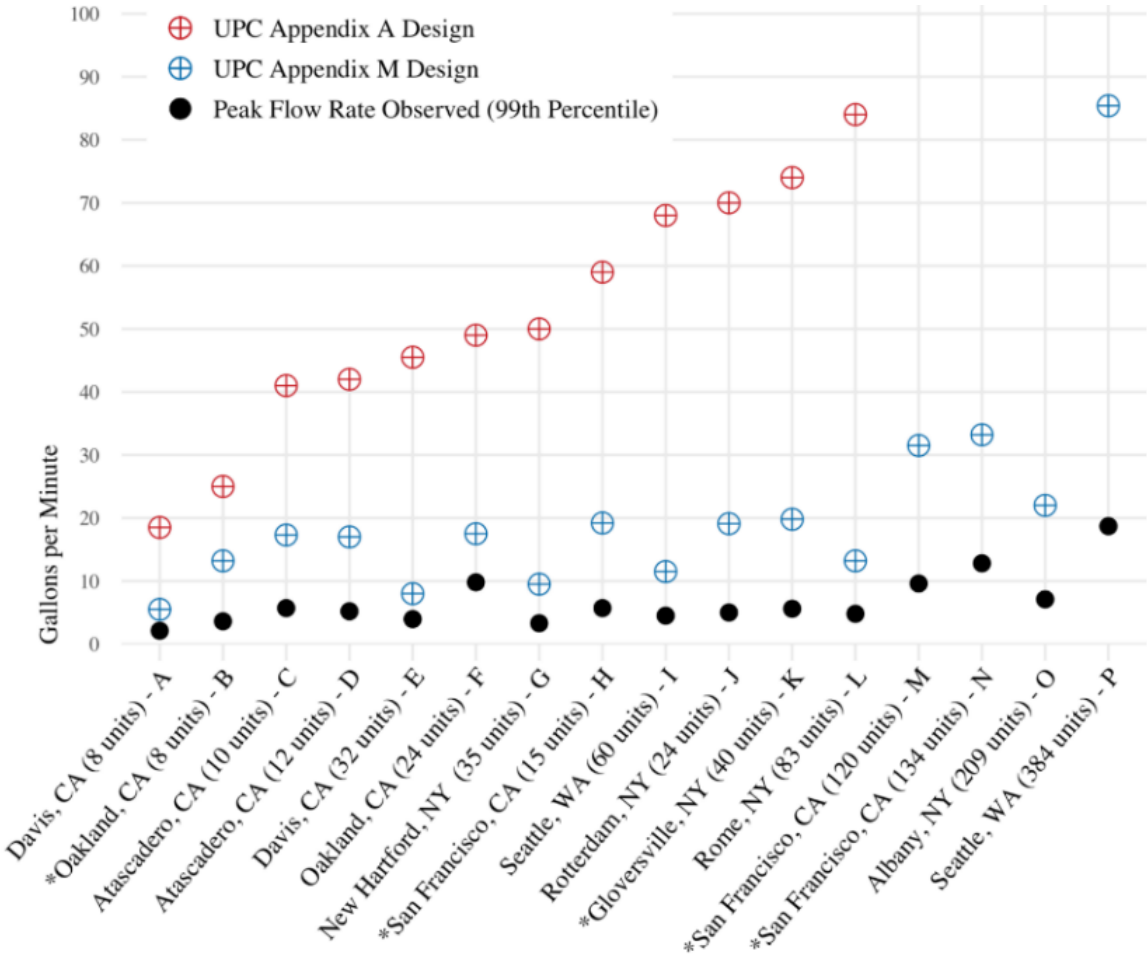

Figure 1: Comparing UPC Appendix A and M design predictions to actual multifamily building peak flow rates.

Source: (Klein 2021), (Steffi Becking, et al. 2023).

3.2.2.3 Municipal Code Adoption in California

The following jurisdictions have adopted CPC Appendix M in their municipal code: Foster City, City of San Jose, City of Oakland, and County of Santa Cruz.

3.2.2.4 Plumbing Code Adoption Outside California

The following jurisdictions have adopted UPC Appendix M into their plumbing code: Hawaii, Nevada, New Mexico, North Dakota, Oregon, and the City of Seattle and King County, Washington. Wisconsin has approved the WDC as an alternative standard.

3.2.2.5 Adapting to New Pipe Sizing Method

The overall design process to size distribution piping with Appendix A and M is not very different as noted in the compliance and enforcement section. Designers that have not used Appendix M would need to learn a new calculation procedure for Appendix M, although the learning curve should be quick because the WDC spreadsheet tool is available for free from IAPMO, and it can be integrated into the existing design process to easily or automatically input results in the design plan drawing software.

3.2.2.6 Stakeholder Support

Appendix M pipe sizing methodology is supported by a wide range of stakeholders as evidenced by funding research, advocacy efforts including fact sheets, presentations, articles, industry partnerships, and developing model plumbing code:

- Alliance for Water Efficiency
- ASPE
- California Codes and Standards Reach Codes Team
- California Water Efficiency Partnership
- IAPMO
- National Institute of Standards and Technology
- Plumbing-Heating-Cooling Contractors—National Association
- Plumbing Manufacturers International
- U.S. Environmental Protection Agency
- University of Cincinnati
- World Plumbing Council

3.2.2.7 Other Considerations

Appendix M sizing is a passive measure that would persist for the life of the materials, and energy savings in a typical building would not diminish over time. There is no maintenance required. The smaller diameter piping materials are widely available at plumbing supply warehouses.

The new pipe sizing procedure may require increased designer calculation time in the short term. Appendix A Fixture Unit calculation is linear and easy to set up in tables, using the water supply demand chart (Hunter’s curve) to calculate flow rate. Setting up and running the IAPMO WDC spreadsheet for each section of pipe would initially take longer as well, which includes the time to integrate data into existing processes. Design processes would mature with a streamlined Appendix M design application or custom calculation to save time. WDC is more precise than look up charts, and there is potential for automation or scripting to eventually become a faster process than Appendix A. The IAPMO Appendix M WDC should be considered for integration into CBECC software to accept inputs and compile outputs for all calculated sections of pipe comprehensively. By providing a compliance form tabulation and print to file option, the CBECC software would make it easier for designers and energy consultants to generate and print documents and building departments to review.

3.2.3 Market Impacts and Economic Assessments

3.2.3.1 Impact on Builders

Builders of residential and commercial structures are directly impacted by many of the measures proposed by the Statewide CASE Team for the 2025 code cycle. It is within the normal practices of these businesses to adjust their building practices to changes in building codes. When necessary, builders engage in continuing education and training to remain compliant with changes to design practices and building codes.

California’s construction industry comprises approximately 93,000 business establishments and 943,000 employees (see Table 14). For 2022, total estimated payroll would be about \$78 billion. Nearly 72,000 of these business establishments and 473,000 employees are engaged in the residential building sector, while another 17,600 establishments and 369,000 employees focus on the commercial sector. The remainder of establishments and employees work in industrial, utilities, infrastructure, and other heavy construction roles (the industrial sector).

Table 14: California Construction Industry, Establishments, Employment, and Payroll in 2022 (Estimated)

Building Type	Construction Sectors	Establishments	Employment	Annual Payroll (Billions \$)
Residential	All	71,889	472,974	31.2
Residential	Building Construction Contractors	27,948	130,580	9.8
Residential	Foundation, Structure, & Building Exterior	7,891	83,575	5.0
Residential	Building Equipment Contractors	18,108	125,559	8.5
Residential	Building Finishing Contractors	17,942	133,260	8.0

Building Type	Construction Sectors	Establishments	Employment	Annual Payroll (Billions \$)
Commercial	All	17,621	368,810	35.0
Commercial	Building Construction Contractors	4,919	83,028	9.0
Commercial	Foundation, Structure, & Building Exterior	2,194	59,110	5.0
Commercial	Building Equipment Contractors	6,039	139,442	13.5
Commercial	Building Finishing Contractors	4,469	87,230	7.4
Industrial, Utilities, Infrastructure, & Other (Industrial+)	All	4,206	101,002	11.4
Industrial+	Building Construction	288	3,995	0.4
Industrial+	Utility System Construction	1,761	50,126	5.5
Industrial+	Land Subdivision	907	6,550	1.0
Industrial+	Highway, Street, and Bridge Construction	799	28,726	3.1
Industrial+	Other Heavy Construction	451	11,605	1.4

Source: (State of California n.d.)

The proposed change to Appendix M would likely affect residential builders, but it would not impact firms that focus on construction and retrofit of industrial buildings, utility systems, public infrastructure, or other heavy construction. The effects on the residential and commercial building industry would not be felt by all firms and workers, but rather would be concentrated in specific industry subsectors. Table 15 shows the residential building subsectors the Statewide CASE Team expects to be impacted by the changes proposed in this report. This proposed change would have minimal impact on multifamily general contractors and plumbing contractors as downsizing of piping slightly reduces material and labor cost for installation, thus slightly lower revenue. The Statewide CASE Team’s estimates of the magnitude of these impacts are shown in Section 3.2.4.

Table 15: Specific Subsectors of the California Residential Building Industry by Subsector in 2022 (Estimated)

Residential Building Subsector	Establishments	Employment	Annual Payroll (Billions \$)
New multifamily general contractors	421	6,344	0.7
New housing for-sale builders	189	3,969	0.5
Residential plumbing and HVAC contractors	9,852	75,404	5.1

Source: (State of California n.d.)

3.2.3.2 Impact on Building Designers and Energy Consultants

Adjusting design practices to comply with changing building codes is within the normal practices of building designers. Building codes (including Title 24, Part 6) are typically updated on a three-year revision cycle and building designers and energy consultants engage in continuing education and training to remain compliant with changes to design practices and building codes.

This code change would not impact the workflow of a builder. It would slightly negatively impact the workflow at the onset of a building designer, architect, engineer, and/or energy consultant, as they adjust design and collaboration processes for this Appendix M pipe sizing methodology. Being that this calculator is digital, there is an opportunity to minimize error with sizing process and automate it, thus saving time and minimizing design or construction change orders.

Businesses that focus on residential, commercial, institutional, and industrial building design are contained within the Architectural Services sector (North American Industry Classification System [NAICS] 541310). Table 16 shows the number of establishments, employment, and total annual payroll for Building Architectural Services. The proposed code changes would potentially impact all firms within the Architectural Services sector. The Statewide CASE Team anticipates the impacts for CPC Appendix M Pipe Sizing to affect firms that focus on multifamily construction.

There is not a NAICS⁷ code specific to energy consultants. Instead, businesses that focus on consulting related to building energy efficiency are contained in the Building Inspection Services sector (NAICS 541350), which is comprised of firms primarily engaged in the physical inspection of residential and nonresidential buildings.⁸ It is not possible to determine which business establishments within the Building Inspection Services sector are focused on energy efficiency consulting. The information shown in Table 16 provides an upper bound indication of the size of this sector in California.

⁷ NAICS is the standard used by federal statistical agencies in classifying business establishments for the purpose of collecting, analyzing, and publishing statistical data related to the U.S. business economy. NAICS was developed jointly by the U.S. Economic Classification Policy Committee (ECPC), Statistics Canada, and Mexico's Instituto Nacional de Estadística y Geografía, to allow for a high level of comparability in business statistics among the North American countries. NAICS replaced the Standard Industrial Classification (SIC) system in 1997.

⁸ Establishments in this sector include businesses primarily engaged in evaluating a building's structure and component systems and includes energy efficiency inspection services and home inspection services. This sector does not include establishments primarily engaged in providing inspections for pests, hazardous wastes or other environmental contaminants, nor does it include state and local government entities that focus on building or energy code compliance/enforcement of building codes and regulations.

Table 16: California Building Designer and Energy Consultant Sectors in 2022 (Estimated)

Sector	Establishments	Employment	Annual Payroll (Millions \$)
Architectural Services⁹	4,134	31,478	3,623.3
Building Inspection Services¹⁰	1,035	3,567	280.7

Source: (State of California n.d.)

3.2.3.3 Impact on Occupational Safety and Health

The proposed code change does not alter any existing federal, state, or local regulations pertaining to safety and health, including rules enforced by the California Division of Occupational Safety and Health (DOSH). All existing health and safety rules would remain in place. Complying with the proposed code change is not anticipated to have adverse impacts on the safety or health of occupants or those involved with the construction, commissioning, and maintenance of the building. This proposed code change would have positive public health impact, reduce safety risk, and improve water quality due to shorter water dwell time in cold and hot water distribution systems.

3.2.3.4 Impact on Building Owners and Occupants Including Homeowners and Potential First-Time Homeowners)

Residential Buildings

According to data from the U.S. Census, American Community Survey (ACS), there were more than 14.5 million housing units in California in 2021 and nearly 13.3 million were occupied (see Table 17). Most housing units (nearly 9.42 million) were single family homes (either detached or attached), approximately 2 million homes were in buildings containing two to nine units, and 2.5 million homes were in multifamily buildings containing 10 or more units. The California Department of Revenue estimated that building permits for 67,300 single family and 54,900 multifamily homes would be issued in 2022, up from 66,000 single family and 53,500 multifamily permits issued in 2021.

⁹Architectural Services (NAICS 541310) comprises private-sector establishments primarily engaged in planning and designing residential, institutional, leisure, commercial, and industrial buildings and structures.

¹⁰ Building Inspection Services (NAICS 541350) comprises private-sector establishments primarily engaged in providing building (residential & nonresidential) inspection services encompassing all aspects of the building structure and component systems, including energy efficiency inspection services.

Table 17: California Housing Characteristics in 2021¹¹

Housing Measure	Estimate
Total housing units	14,512,281
Occupied housing units	13,291,541
Vacant housing units	1,220,740
Homeowner vacancy rate	0.7%
Rental vacancy rate	4.3%
Number of 1-unit, detached structures	8,388,099
Number of 1-unit, attached structures	1,030,372
Number of 2-unit structures	348,295
Number of 3- or 4-unit structures	783,663
Number of 5- to 9-unit structures	856,225
Number of 10- to 19-unit structures	740,126
Number of 20+ unit structures	1,828,547
Mobile home, RV, etc.	522,442

Sources: (United States Census Bureau n.d.), (Federal Reserve Economic Data (FRED) n.d.)

Table 18 shows the distribution of California homes by vintage. About 15 percent of California homes were built in 2000 or later and another 11 percent built between 1990 and 1999. The majority of California’s existing housing stock (8.5 million homes – 59 percent of the total) were built between 1950 and 1989, a period of rapid population and economic growth in California. Finally, about 2.1 million homes in California were built before 1950. According to Kenney et al, 2019, more than half of California’s existing multifamily buildings (those with five or more units) were constructed before 1978 when there were no building energy efficiency standards (Kenney 2019).

Table 18: Distribution of California Housing by Vintage in 2021 (Estimated)

Home Vintage	Units	Percent	Cumulative Percent
Built 2014 or later	348,296	2.4	2.4
Built 2010 to 2013	261,221	1.8	4.2
Built 2000 to 2009	1,581,839	10.9	15.1
Built 1990 to 1999	1,596,351	11.0	26.1
Built 1980 to 1989	2,191,354	15.1	41.2
Built 1970 to 1979	2,539,649	17.5	58.7
Built 1960 to 1969	1,915,621	13.2	71.9
Built 1950 to 1959	1,930,133	13.3	85.2
Built 1940 to 1949	841,712	5.8	91.0
Built 1939 or earlier	1,306,105	9.0	100.0
Total housing units	14,512,281	100.0	–

Sources: (United States Census Bureau n.d.), (Federal Reserve Economic Data (FRED) n.d.)

¹¹ Total housing units as reported for 2021; all other housing measures estimated based on historical relationships.

Table 19 shows the distribution of owner- and renter-occupied housing by household income. Overall, about 55 percent of California housing is owner-occupied and the rate of owner-occupancy generally increases with household income. The owner-occupancy rate for households with an income below \$50,000 is only 37 percent, whereas the owner occupancy rate is 71 percent for households earning \$100,000 or more.

Table 19: Owner- and Renter-Occupied Housing Units in California by Income in 2021 (Estimated)

Household Income	Total	Owner Occupied	Renter Occupied
Less than \$5,000	353,493	113,315	240,178
\$5,000 to \$9,999	254,304	74,939	179,366
\$10,000 to \$14,999	495,287	134,633	360,654
\$15,000 to \$19,999	412,498	144,064	268,435
\$20,000 to \$24,999	467,694	169,431	298,264
\$25,000 to \$34,999	906,996	355,968	551,028
\$35,000 to \$49,999	1,319,892	560,453	759,438
\$50,000 to \$74,999	2,036,560	990,769	1,045,791
\$75,000 to \$99,999	1,662,032	920,607	741,425
\$100,000 to \$149,999	2,307,889	1,490,247	817,642
\$150,000 or more	3,074,895	2,337,651	737,244
Total Housing Units	13,291,541	7,292,076	5,999,465

Source: (United States Census Bureau n.d.), (Federal Reserve Economic Data (FRED) n.d.)

Understanding the distribution of California residents by home type, home vintage, and household income is critical for developing meaningful estimates of the economic impacts associated with proposed code changes affecting residents. Many proposed code changes specifically target single family or multifamily residences and so the counts of housing units by building type shown in Table 19. Table 17 provides the information necessary to quantify the magnitude of potential impacts. Likewise, impacts may differ for owners and renters, by home vintage, and by household income, information provided in Table 18 and Table 19.

Estimating Impacts

For California residents, the proposed code changes would result in lower energy bills. The Statewide CASE Team estimates that on average the proposed change to Title 24, Part 6 would represent a \$0 increase in construction cost per multifamily dwelling unit, and the measure would also result in an average savings of \$707 in energy and maintenance cost savings over 30 years. This is roughly equivalent to a \$0 per month increase in payments for a 30-year mortgage and a \$1.96 per month reduction in energy costs. Overall, the Statewide CASE Team expects the 2025 Title 24, Part 6

Standards to save homeowners about \$24 per year relative to homeowners whose dwelling units are minimally compliant with the 2022 Title 24, Part 6 requirements. As discussed in section 3.2.4.1 when homeowners or building occupants save on energy bills, they tend to spend it elsewhere thereby creating jobs and economic growth for the California economy. Energy cost savings can be particularly beneficial to low-income homeowners who typically spend a higher portion of their income on energy bills, often have trouble paying energy bills, and sometimes go without other necessities to save money for energy bills (Association, National Energy Assistance Directors 2011).

3.2.3.5 Impact on Building Component Retailers (Including Manufacturers and Distributors)

The proposed code change would have minimal impact on building component retailers, including manufacturers and distributors. Unit counts of products would not change, just the sizing of piping, fittings, appurtenances, pipe supports, and insulation would be slightly reduced leading to slight revenue reduction for building component retailers.

3.2.3.6 Impact on Building Inspectors

Table 20 shows employment and payroll information for state and local government agencies in which many inspectors of residential and commercial buildings are employed. Building inspectors participate in continuing education and training to stay current on all aspects of building regulations, including energy efficiency. Therefore, the Statewide CASE Team anticipates the proposed change would have no impact on employment of building inspectors or the scope of their role conducting energy efficiency inspections.

Table 20: Employment in California State and Government Agencies with Building Inspectors in 2022 (Estimated)

Sector	Govt.	Establishments	Employment	Annual Payroll (Million \$)
Administration of Housing Programs¹²	State	18	265	29.0
	Local	38	3,060	248.6
Urban and Rural Development Admin¹³	State	38	764	71.3
	Local	52	2,481	211.5

Source: (State of California, Employment Development Department n.d.)

¹² Administration of Housing Programs (NAICS 925110) comprises government establishments primarily engaged in the administration and planning of housing programs, including building codes and standards, housing authorities, and housing programs, planning, and development.

¹³ Urban and Rural Development Administration (NAICS 925120) comprises government establishments primarily engaged in the administration and planning of the development of urban and rural areas. Included in this industry are government zoning boards and commissions.

3.2.3.7 Impact on Statewide Employment

As described in Sections 3.2.3.1 through 3.2.3.6, the Statewide CASE Team does not anticipate significant employment or financial impacts to any sector of the California economy. This is not to say that the proposed change would not have modest impacts on employment in California. In Section 3.2.4, the Statewide CASE Team estimated the proposed change in Appendix M would affect statewide employment and economic output directly and indirectly through its impact on builders, designers and energy consultants, and building inspectors. In addition, the Statewide CASE Team estimated how energy savings associated with the proposed change Appendix M would lead to modest ongoing financial savings for California residents, which would then be available for other economic activities.

3.2.4 Economic Impacts

For the 2025 code cycle, the Statewide CASE Team used the IMPLAN model software,¹⁴ along with economic information from published sources and professional judgement to develop estimates of the economic impacts associated with each of the proposed code changes. Conceptually, IMPLAN estimates jobs created as a function of incoming cash flow in different sectors of the economy, due to implementing a code or a standard. The jobs created are typically categorized into direct, indirect, and induced employment. For example, cash flow into a manufacturing plant captures direct employment (jobs created in the manufacturing plant), indirect employment (jobs created in the sectors that provide raw materials to the manufacturing plant), and induced employment (jobs created in the larger economy due to purchasing habits of people newly employed in the manufacturing plant). Eventually, IMPLAN computes the total number of jobs created due to a code. The assumptions of IMPLAN include constant returns to scale, fixed input structure, industry homogeneity, no supply constraints, fixed technology, and constant byproduct coefficients. The model is also static in nature and is a simplification of how jobs are created in the macro-economy.

The economic impacts developed for this report are only estimates and are based on limited and to some extent speculative information. The IMPLAN model provides a relatively simple representation of the California economy and, though the Statewide CASE Team is confident that the direction and approximate magnitude of the estimated economic impacts are reasonable, it is important to understand that the IMPLAN model is a simplification of extremely complex actions and interactions of individual, businesses, and other organizations as they respond to changes in energy efficiency codes. In all aspects of this economic analysis, the Statewide CASE Team relies on conservative assumptions regarding the likely economic benefits associated with the

¹⁴ IMPLAN employs economic data and advanced economic impact modeling to estimate economic impacts for interventions like changes to the California Title 24, Part 6 code. For more information on the IMPLAN modeling process, see www.IMPLAN.com.

proposed code change. By following this approach, the economic impacts presented below represent lower bound estimates of the actual benefits associated with this proposed code change.

Adoption of this code change proposal would result in relatively modest economic savings for developers of residential buildings, and it would not impact the remodeling industry, architects, energy consultants, and building inspectors. Indirectly, residents would spend all or some of the money saved through lower utility bills on other economic activities.¹⁵ There may also be some nonresidential customers that are impacted by this proposed code change; however, the Statewide CASE Team does not anticipate such impacts to be materially important to the building owner and would have measurable economic impacts.

Table 21: Estimated Impact that Adoption of the Proposed Measure would have on the California Residential Construction Sector

Type of Economic Impact	Employment (Jobs)	Labor Income	Total Value Added	Output
Direct Effects (Additional spending by Residential Builders)	-9.4	(\$742,989)	\$20,312,346	\$24,771,648
Indirect Effect (Additional spending by firms supporting Residential Builders)	23.3	\$1,752,116	\$2,853,721	\$4,921,363
Induced Effect (Spending by employees of firms experiencing “direct” or “indirect” effects)	-3.5	(\$237,887)	(\$425,899)	(\$677,870)
Total Economic Impacts	10.4	\$771,241	\$22,740,168	\$29,015,142

Source: Statewide CASE Team analysis of data from the IMPLAN modeling software.¹⁶

Table 22: Estimated Impact that Adoption of the Proposed Measure would have on the California Building Designers and Energy Consultants Sectors

Type of Economic Impact	Employment (Jobs)	Labor Income	Total Value Added	Output
Direct Effects (Additional spending by Building Designers & Energy Consultants)	0.3	\$31,610	\$31,293	\$49,462
Indirect Effect (Additional spending by firms supporting Bldg. Designers & Energy Consultants)	0.1	\$9,412	\$13,081	\$21,057
Induced Effect (Spending by employees of firms experiencing “direct” or “indirect” effects)	0.2	\$11,796	\$21,123	\$33,621
Total Economic Impacts	0.6	\$52,817	\$65,497	\$104,140

Source: Statewide CASE Team analysis of data from the IMPLAN modeling software.

¹⁵ For example, for the lowest income group, the Statewide CASE Team assumes 100 percent of money saved through lower energy bills would be spent, while for the highest income group, the Statewide CASE Team assumes only 64 percent of additional income would be spent.

¹⁶ IMPLAN® model, 2020 Data, IMPLAN Group LLC, IMPLAN System (data and software), 16905 Northcross Dr., Suite 120, Huntersville, NC 28078 www.IMPLAN.com

Table 23: Estimated Impact that Adoption of the Proposed Measure would have on California Building Inspectors

Type of Economic Impact	Employment (Jobs)	Labor Income	Total Value Added	Output
Direct Effects (Additional spending by Building Inspectors)	0.1	\$15,947	\$18,911	\$22,981
Indirect Effect (Additional spending by firms supporting Building Inspectors)	0.0	\$1,477	\$2,300	\$4,006
Induced Effect (Spending by employees of Building Inspection Bureaus and Departments)	0.1	\$5,016	\$8,985	\$14,301
Total Economic Impacts	0.2	\$22,440	\$30,197	\$41,289

Source: Statewide CASE Team analysis of data from the IMPLAN modeling software.

3.2.4.1 Creation or Elimination of Jobs

The Statewide CASE Team does not anticipate that the measures proposed for the 2025 code cycle regulation would lead to the creation of new *types* of jobs or the elimination of *existing* types of jobs. In other words, the Statewide CASE Team’s proposed change would not result in economic disruption to any sector of the California economy. Rather, the estimates of economic impacts discussed in Section 3.2.4 would lead to modest changes in employment of existing jobs.

3.2.4.2 Creation or Elimination of Businesses in California

As stated in Section 3.2.3 , the Statewide CASE Team’s proposed change would not result in economic disruption to any sector of the California economy. The proposed change represents a modest change to designers/energy consultant which would not excessively burden or competitively disadvantage California businesses—nor would it necessarily lead to a competitive advantage for California businesses. Therefore, the Statewide CASE Team does not foresee any new businesses being created, nor does the Statewide CASE Team think any existing businesses would be eliminated due to the proposed code changes.

3.2.4.3 Competitive Advantages or Disadvantages for Businesses in California

The proposed code changes would apply to all businesses incorporated in California, regardless of whether the business is located inside or outside of the state.¹⁷ Therefore, the Statewide CASE Team does not anticipate that these measures proposed for the 2025 code cycle regulation would have an adverse effect on the competitiveness of

¹⁷ Gov. Code, §§ 11346.3(c)(1)(C), 11346.3(a)(2); 1 CCR § 2003(a)(3) Competitive advantages or disadvantages for California businesses currently doing business in the state.

California businesses. Likewise, the Statewide CASE Team does not anticipate businesses located outside of California would be advantaged or disadvantaged.

3.2.4.4 Increase or Decrease of Investments in the State of California

The Statewide CASE Team analyzed national data on corporate profits and capital investment by businesses that expand a firm’s capital stock (referred to as net private domestic investment, or NPDI).¹⁸ As Table 24 shows, between 2017 and 2021, NPDI as a percentage of corporate profits ranged from a low of 18 in 2020 due to the worldwide economic slowdowns associated with the COVID-19 pandemic to a high of 35 percent in 2019, with an average of 26 percent. While only an approximation of the proportion of business income used for net capital investment, the Statewide CASE Team believes it provides a reasonable estimate of the proportion of proprietor income that would be reinvested by business owners into expanding their capital stock.

Table 24: Net Domestic Private Investment and Corporate Profits, U.S.

Year	Net Domestic Private Investment by Businesses, Billions of Dollars	Corporate Profits After Taxes, Billions of Dollars	Ratio of Net Private Investment to Corporate Profits (Percent)
2017	518.473	1882.460	28
2018	636.846	1977.478	32
2019	690.865	1952.432	35
2020	343.620	1908.433	18
2021	506.331	2619.977	19
5-Year Average	-	-	26

Source: (Federal Reserve Economic Data (FRED) n.d.)

The Statewide CASE Team estimates that the sum of proposed code changes in this report would increase investment in California by \$1,310,430.

3.2.4.5 Incentives for Innovation in Products, Materials, or Processes

Typical current designer practice when sizing piping for domestic water systems is to use CPC Appendix A, which generally results in larger pipe sizes in the piping system. The use of Appendix M in sizing pipe would result in overall cost savings in material and well as physical space in the building. Also, the use of Appendix M methodology would more closely match the low flow design of the modern end-use plumbing fixtures.

¹⁸ Net private domestic investment is the total amount of investment in capital by the business sector that is used to expand the capital stock, rather than maintain or replace due to depreciation. Corporate profit is the money left after a corporation pays its expenses.

3.2.4.6 Effects on the State General Fund, State Special Funds, and Local Governments

The Statewide CASE Team does not expect the proposed code changes would have a measurable impact on California’s General Fund, any state special funds, or local government funds.

Cost of Enforcement

Cost to the State: State government already has budget for code development, education, and compliance enforcement. While state government would be allocating resources to update the Title 24, Part 6 Standards, including updating education and compliance materials and responding to questions about the revised requirements, these activities are already covered by existing state budgets. The costs to state government are small when compared to the overall costs savings and policy benefits associated with the code change proposals.

Cost to Local Governments: All proposed code changes to Title 24, Part 6 would result in changes to compliance determinations. Local governments would need to train building department staff on the revised Title 24, Part 6 Standards. While this re-training is an expense to local governments, it is not a new cost associated with the 2025 code change cycle. The building code is updated on a triennial basis, and local governments plan and budget for retraining every time the code is updated. There are numerous resources available to local governments to support compliance training that can help mitigate the cost of retraining, including tools, training and resources provided by the IOU Codes and Standards program (such as Energy Code Ace). As noted in Section 3.2.3 and Appendix E, the Statewide CASE Team considered how the proposed code change might impact various market actors involved in the compliance and enforcement process and aimed to minimize negative impacts on local governments.

3.2.4.7 Impacts on Specific Persons

While the objective of any of the Statewide CASE Team’s proposal is to promote energy efficiency, the Statewide CASE Team recognizes that there is the potential that a proposed code change may result in unintended consequences. Refer to Section 3.6 for more details addressing energy equity and environmental justice.

3.2.5 Fiscal Impacts

3.2.5.1 Mandates on Local Agencies or School Districts

There are no relevant mandates to local agencies or school districts due to the nature of the measure in providing a fiscal benefit to the operator of school district buildings from the water and energy savings related to this measure.

3.2.5.2 Costs to Local Agencies or School Districts

There are no costs to local agencies or school districts due to the nature of the measure being a cost saving plumbing measure for the developer during construction of a building and water and energy saving measure for the operator of the building.

3.2.5.3 Costs or Savings to Any State Agency

There are no costs or savings to any state agencies due to the nature of the measure being a cost saving plumbing measure for the developer during construction of a building. Appendix M methodology is rooted from decades of state and federal water and energy efficiency standards that reduced end use fixture water use in buildings and allowed for the development of this new methodology that better matches modern end-use water fixtures.

3.2.5.4 Other Non-Discretionary Cost or Savings Imposed on Local Agencies

Water utilities benefit from smaller water meters being used for smaller pipes based on Appendix M sizing. Smaller mains meters are better at detecting leaks, potentially saving water for utilities and customers (CalWEP 2021). Conversely, water utility monthly service charges would be reduced with the use of smaller meters impacting revenue for water utilities. Similarly, revenue is reduced in the construction phase for water and wastewater districts that charge developers water and sewer capacity charges based on mains meter size.

3.2.5.5 Costs or Savings in Federal Funding to the State

There are no costs or savings to federal funding to the state due to the nature of the measure in being a cost saving plumbing measure for the developer during a construction of a building. Appendix M methodology is rooted from decades of state and federal water and energy efficiency standards that reduced end use fixture water use in buildings and allowed for the development of this new methodology that better matches modern end-use water fixtures.

3.3 Energy Savings

The prescriptive code change proposal would increase the stringency of the existing California Energy Code, so there would be savings on a per-unit basis.

The Statewide CASE Team gathered stakeholder input to inform the energy savings analysis. See Appendix F for a summary of stakeholder engagement.

Energy savings benefits may have potential to disproportionately impact DIPs. Refer to Section 3.6 for more details addressing energy equity and environmental justice.

3.3.1 Energy Savings Methodology

The Statewide CASE Team used a recirculation heat loss spreadsheet calculator and a heating plant pipe heat loss spreadsheet calculator to assess the energy impact of the proposed code change. The former is for assessing pipe heat loss of recirculation-based hot water distribution systems, and the latter is for assessing pipe heat loss of water heating plants. Details of both spreadsheet calculators are provided in Appendix H.

The recirculation heat loss spreadsheet calculator used pipe heat loss calculation methods defined in the existing 2022 ACM Reference Manual. The spreadsheet calculator includes features to handle detailed recirculation piping designs, insulation conditions, and recirculation flow controls. In comparison, CBECC uses a simple recirculation model with six pipe sections to streamline code compliance, but they are not capable of assessing the energy impact of complicated recirculation system designs found in real buildings. The recirculation heat loss calculator was used to support energy impact analysis during the 2022 Code Cycle for multifamily DHW distribution measures.

The plant pipe heater loss spreadsheet calculator also uses pipe heat loss calculation methods defined in the existing 2022 ACM Reference Manual. This calculator uses a simplified approach to handle pipe temperature variations as affected by hot water drawers and heating equipment controls. An average pipe temperature was used for all pipes in the water heating plant for heat loss calculation.

Based on the output of the recirculation heat loss calculator, the Statewide CASE Team calculated site, source, and Long-term Systemwide Cost (LSC) savings as described in following sections.

3.3.1.1 Key Assumptions for Energy Savings Analysis

The CEC directed the Statewide CASE Team to assess the energy impacts of proposed code changes for four prototypical multifamily buildings, as shown in Table 26. Detailed recirculation system piping configurations for these four prototypical buildings were developed during the 2022 Code Cycle (see Appendix I) and were incorporated into the recirculation heat loss spreadsheet calculator to assess distribution heat loss. For each prototypical building, the Statewide CASE Team developed two types of water heating plant: one based on HPWHs and the other based on gas boilers. The corresponding piping and appurtenance configurations were used to evaluate plant pipe heat loss.

Table 25 provides key assumptions for energy impact analysis for the proposed code change. Please see Appendix H for more details.

Table 25: Key Assumptions for Assessing Energy Impact of Using CPC Appendix M for Pipe Sizing

Metric	Key Assumption
% of pipes not insulated (Distribution system)	LowRiseGarden: 52%, LoadedCorridor: 43% MidRiseMixedUse: 38.5%, HighRiseMixedUse: 43%
% of pipes not insulated (Water heating plant)	Straight pipes: 30%, appurtenances: 100%
Balancing valve configurations	Manual balancing valves set to have 0.5 GPM recirculation flow per riser
Recirculation flow controls	None

Assumptions for both the base case (CPC Appendix A pipe sizing method for distribution system and water heating plant) and the proposed case (CPC Appendix M pipe sizing method for distribution system and water heating plant)

The Statewide CASE Team modeled pipe heat loss from using Appendix A and Appendix M and calculated heat loss savings from changing from an Appendix A piping design to an Appendix M piping design for all prototypes and climate zones. Then, the Statewide CASE Team conducted post processing of the simulation results to calculate per dwelling unit energy savings at the heating plant. For gas-fired HWS, the Statewide CASE Team assumed the same distribution heat loss as HPWH, and it converted pipe heat loss savings to plant energy savings using average heat pump operating coefficient of performance (COP) of 3.0 and average gas-fired heater operating efficiency of 80 percent.

3.3.1.2 Energy Savings Methodology per Prototypical Building

The CEC directed the Statewide CASE Team to assess the energy impacts of proposed code change for four prototypical multifamily buildings, as shown in Table 26.

First, savings are calculated by fuel type. Electricity savings are measured in terms of both energy usage and peak demand reduction. Natural gas savings are quantified in terms of energy usage. For each prototypical multifamily building, the Statewide CASE Team used the spreadsheet calculator to obtain hourly recirculation pipe heat loss for both the base case and proposed recirculation system. The Statewide CASE Team then calculated the corresponding hourly DHW system energy consumption (Therms for natural gas systems and kWh for HPWH systems) by dividing the hourly recirculation pipe heat loss by the heating plant efficiency. Annual site energy consumption for recirculation system operation was obtained by summing up the hourly DHW system energy consumption for the whole year. The first-year site energy savings (Therms/yr for natural gas systems and kWh/yr for HPWH systems) of the proposed code change was calculated as the difference in annual site energy consumption between the proposed and base case recirculation systems.

For both the base case and proposed recirculation systems, annual peak electricity demand (kW) was calculated based on weighted average hourly kWh consumption during grid peak hours. Both peak hours and corresponding weighting factors are provided by the CEC. Annual peak reduction (kW) of the proposed code change was calculated as the difference in annual peak electricity demand between the base case and proposed recirculation systems.

Second, the Statewide CASE Team calculated source energy savings. Source Energy represents the total amount of fuel required to operate a building. In addition to all energy used from on-site production, source energy incorporates all transmission, delivery, and production losses. The hourly source energy factors provided by the CEC are strongly correlated to GHG emissions. The Statewide CASE Team calculated source energy use in kilo British thermal units per year (kBtu/yr) by applying source energy factors to hourly DHW system energy consumption and summing the hourly results for the whole year. Source energy savings is calculated as the difference in source energy use between the base and the proposed cases.

The hourly source energy values provided by the CEC are strongly correlated with GHG emissions.¹⁹ The Statewide CASE Team calculated GHG emissions (metric tons of carbon dioxide emissions equivalent) by applying hourly GHG emissions factors to hourly DHW system energy consumption and summing the hourly results for the whole year. GHG emissions reduction is calculated as the difference in GHG emissions between the base and the proposed cases. Finally, the Statewide CASE Team calculated LSC Savings, formerly known as Time Dependent Valuation (TDV) Energy Cost Savings. LSC Savings are calculated using hourly energy cost metrics for both electricity and natural gas provided by the CEC. These LSC hourly factors are projected over the 30-year life of the building, and they incorporate the hourly cost of marginal generation, transmission and distribution, fuel, capacity, losses, and cap-and-trade-based CO₂ emissions.¹² The Statewide CASE Team applied 2025 LSC hourly factors to hourly DHW system energy consumption values and summed hourly results for the whole year to obtain LSC in 2026 present value dollars (2026 PV\$). LSC Savings are the difference in LSC between the base and proposed cases.

¹⁹ See hourly factors for source energy, LSC, and GHG emissions at <https://www.energy.ca.gov/files/2025-energy-code-hourly-factors>

Table 26: Prototype Buildings Used for Energy, Demand, Cost, and Environmental Impacts Analysis

Prototype Name	Number of Stories	Floor Area (Square Feet)	Description
LowRise Garden	2	7,680	8-unit apartment building. Gas fired and HPWH central DHW heater serving a central recirculation loop. Water heater is located on one end the of building at the ground level. Distribution piping runs horizontally in ceiling of ground floor, vertically up four risers, and returns in the ceiling of the second floor. ²⁰ Average dwelling unit size: 960 ft2. DHW Distribution: pipe size follows CPC Appendix A for base case
Loaded Corridor	3	40,000	36-unit apartment building. Gas fired and HPWH central DHW heater serving a central recirculation loop. Water heater is located in a mechanical room at the ground level. Distribution piping runs horizontally in ceiling of ground floor, vertically up 13 risers, and returns in the ceiling of the third floor. Average dwelling unit size: 960 ft2. DHW Distribution: pipe size follows CPC Appendix A for base case
MidRise MixedUse	5	113,100	(4-story residential, 1-story commercial), 88-unit building. Gas fired and HPWH central DHW heater serving dwelling units from a central recirculation loop. Water heater is located in a mechanical room at the ground level (commercial level). Distribution piping runs horizontally in ceiling of second floor (first residential level), vertically up 22 risers, and returns in the ceiling of the fifth floor. Avg dwelling unit size: 870 ft2. DHW Distribution: pipe size follows CPC Appendix A for base case
HighRise MixedUse	10	125,400	10-story (9-story residential, 1-story commercial), Gas fired and HPWH central DHW heater serving dwelling units from a central recirculation loop. Water heater is located on the roof. Distribution piping runs horizontally in ceiling of top floor, vertically down 26 risers. There are two pressure zones divided vertically, each with horizontal supply and return piping. Avg dwelling unit size: 850 ft2. DHW Distribution: pipe size follows CPC Appendix A for base case

There are no existing requirements in Title 24, Part 6 cover DHW system pipe sizing. The Statewide CASE Team modified the Standard Design, so it calculated energy impacts of the most common current design practice or industry standard practice.

The Proposed Design was identical to the Standard Design in all ways except for the revisions that represent the proposed changes to the code. Table 27 presents precisely which parameters were modified and what values were used in the Standard Design

²⁰ This DHW Distribution CASE topic and the Central HPWH CASE topic are analyzing a central system in the Low-Rise Garden prototype. The Low-Rise Garden prototype for other CASE topics assumes individual water heaters for each dwelling unit.

and Proposed Design. Specifically, the proposed conditions assume the pipe sizing follows CPC Appendix M.

Table 27: Modifications Made to Standard Design in Each Prototype to Simulate Proposed Code Change

Prototype ID	Climate Zone	Objects Modified	Parameter Name	Standard Design Parameter Value	Proposed Design Parameter Value
LowRiseGarden	All	DHW Distribution	Pipe sizing	Follow CPC Appendix A	Follow CPC Appendix M
LoadedCorridor	All	DHW Distribution	Pipe sizing	Follow CPC Appendix A	Follow CPC Appendix M
MidRiseMixedUse	All	DHW Distribution	Pipe sizing	Follow CPC Appendix A	Follow CPC Appendix M
HighRiseMixedUse	All	DHW Distribution	Pipe sizing	Follow CPC Appendix A	Follow CPC Appendix M

The energy impacts of the proposed code change vary by climate zone. However, the variations in site energy savings are small (less than one percent). For the loaded corridor prototype building, the Statewide CASE Team assessed the energy impacts in every climate zone and applied the climate-zone specific LSC hourly factors when calculating energy and energy cost impacts. Because the variations in site energy savings are small for the other three prototype buildings, the Statewide CASE Team assessed the energy impacts for four representative climate zones: 3, 9, 12, and 15, and it extrapolated savings to the other climate zones according to the variation among climate zones for the base case.

Per-unit energy impacts for multifamily buildings are presented in savings per residential unit. Annual energy and peak demand impacts for each prototype building were translated into impacts per dwelling unit by dividing by the number of dwelling units in the prototype building. This step enables a calculation of statewide savings using the construction forecast that is published in terms of number of multifamily dwelling units by climate zone.

3.3.1.3 Statewide Energy Savings Methodology

The per-unit energy impacts were extrapolated to statewide impacts using the Statewide Construction Forecasts that the Energy CEC provided. The Statewide Construction Forecasts estimate new construction that would occur in 2026, the first year that the 2025 Title 24, Part 6 requirements are in effect. The construction forecast provides new construction by building type and climate zone, as shown in Appendix A,

which also presents additional information about the methodology and assumptions used to calculate statewide energy impacts.

3.3.2 Per-Unit Energy Impacts Results

Energy savings and peak demand reductions per unit are presented in Table 28 through Table 34. The per-unit energy savings figures do not account for naturally occurring market adoption or compliance rates.

For HPWH-AppM LowRiseGarden, per-unit annual savings are expected to range from 55 to 67 kWh/unit depending upon climate zones. There is no gas usage in all climate zones for both base case and proposed case. Demand reductions are expected to range between 7 kW and 8 kW depending on the climate zone.

For HPWH-AppM LoadedCorridor, per-unit annual savings are expected to range from 102 to 116 kWh/unit depending upon climate zones. There is no gas usage in all climate zones for both base case and proposed case. Demand reductions are expected to range between 12 kW and 13 kW depending on the climate zone.

For HPWH-AppM MidRiseMixedUse, per-unit annual savings are expected to range from 115 to 137 kWh/unit depending upon climate zones. There is no gas usage in all climate zones for both base case and proposed case. Demand reductions are expected to range between 14 kW and 16 kW depending on the climate zone.

For HPWH-AppM HighRiseMixedUse, per-unit annual savings are expected to range from 75 to 88 kWh/unit depending upon climate zones. There is no gas usage in all climate zones for both base case and proposed case. Demand reductions are expected to range between 9 kW and 10 kW depending on the climate zone.

For Gas-AppM LowRiseGarden, there are no per-unit electricity saving in all climate zones for the base case. The per dwelling-unit natural gas savings range from 235 to 287. There are no demand reductions for any of the climate zones.

For Gas-AppM LoadedCorridor, there are no per-unit electricity saving in all climate zones for the base case. The per dwelling-unit natural gas savings range from 769 to 829. There are no demand reductions for any of the climate zones.

For Gas-AppM MidRiseMixedUse, there are no per-unit electricity saving in all climate zones for the base case. The per dwelling-unit natural gas savings range from 661 to 753. There are no demand reductions for any of the climate zones.

For Gas-AppM HighRiseMixedUse, there are no per-unit electricity saving in all climate zones for the base case. The per dwelling-unit natural gas savings range from 594 to 648. There are no demand reductions for any of the climate zones.

Table 28: Annual Electricity Savings (kWh) Per Dwelling Unit by Climate Zone (CZ) – HPWH-AppM

Prototype	CZ 1	CZ 2	CZ 3	CZ 4	CZ 5	CZ 6	CZ 7	CZ 8	CZ 9	CZ 10	CZ 11	CZ 12	CZ 13	CZ 14	CZ 15	CZ 16
LowRiseGarden	67	61	61	61	65	60	59	58	58	59	60	60	60	60	55	62
LoadedCorridor	116	109	109	108	113	107	105	105	106	106	107	107	107	107	102	110
MidRiseMixedUse	137	126	127	124	132	123	121	120	121	122	124	124	123	123	115	127
HighRiseMixedUse	88	81	82	81	85	80	78	78	78	79	80	80	80	80	75	82

Table 29: Annual Peak Demand Reduction (kW) Per Dwelling Unit by Climate Zone (CZ) – HPWH-AppM

Prototype	CZ 1	CZ 2	CZ 3	CZ 4	CZ 5	CZ 6	CZ 7	CZ 8	CZ 9	CZ 10	CZ 11	CZ 12	CZ 13	CZ 14	CZ 15	CZ 16
LowRiseGarden	8	7	7	7	8	7	7	7	7	7	7	7	7	7	7	7
LoadedCorridor	13	13	13	13	13	13	13	13	13	13	13	13	13	13	12	13
MidRiseMixedUse	16	15	15	15	16	15	14	14	14	14	15	15	15	15	14	15
HighRiseMixedUse	10	10	10	10	10	9	9	9	9	9	9	9	9	9	9	10

Table 30: Annual Source Energy Savings (kBtu) Per Dwelling Unit by Climate Zone (CZ) – HPWH-AppM

Prototype	CZ 1	CZ 2	CZ 3	CZ 4	CZ 5	CZ 6	CZ 7	CZ 8	CZ 9	CZ 10	CZ 11	CZ 12	CZ 13	CZ 14	CZ 15	CZ 16
LowRiseGarden	119	108	108	107	114	105	103	103	104	104	106	107	105	106	99	109
LoadedCorridor	198	190	191	189	194	188	184	185	186	187	189	189	188	189	180	191
MidRiseMixedUse	240	220	222	218	231	216	212	211	212	213	217	217	215	216	202	223
HighRiseMixedUse	154	142	143	141	149	140	137	137	137	138	140	140	139	140	131	144

Table 31: Annual LSC Savings (kBtu) Per Dwelling Unit by Climate Zone (CZ) – HPWH-AppM

Prototype	CZ 1	CZ 2	CZ 3	CZ 4	CZ 5	CZ 6	CZ 7	CZ 8	CZ 9	CZ 10	CZ 11	CZ 12	CZ 13	CZ 14	CZ 15	CZ 16
LowRiseGarden	456	415	416	408	437	405	393	393	395	399	405	405	401	405	374	422
LoadedCorridor	778	735	738	727	759	725	707	711	713	717	724	724	720	724	688	743
MidRiseMixedUse	924	850	857	838	890	832	809	810	815	820	832	833	825	831	774	862
HighRiseMixedUse	593	550	554	542	573	539	525	526	529	532	539	540	535	538	505	557

Table 32: Annual Natural Gas Savings (kBtu) Per Dwelling Unit by Climate Zone (CZ) – Gas-AppM

Prototype	CZ 1	CZ 2	CZ 3	CZ 4	CZ 5	CZ 6	CZ 7	CZ 8	CZ 9	CZ 10	CZ 11	CZ 12	CZ 13	CZ 14	CZ 15	CZ 16
LowRiseGarden	287	261	262	259	276	255	250	248	249	252	257	255	255	256	235	264
LoadedCorridor	829	799	802	795	816	791	785	784	785	788	793	794	791	792	769	802
MidRiseMixedUse	753	706	711	701	733	695	685	683	686	689	698	698	694	697	661	712
HighRiseMixedUse	648	620	623	617	636	614	608	607	608	610	616	616	613	615	594	624

Table 33: Annual Source Energy Savings (kBtu) Per Dwelling Unit by Climate Zone (CZ) - Gas-AppM

Prototype	CZ 1	CZ 2	CZ 3	CZ 4	CZ 5	CZ 6	CZ 7	CZ 8	CZ 9	CZ 10	CZ 11	CZ 12	CZ 13	CZ 14	CZ 15	CZ 16
LowRiseGarden	260	237	237	234	250	230	224	224	224	227	233	231	230	230	211	238
LoadedCorridor	751	723	726	720	739	712	704	705	707	709	718	718	716	713	692	722
MidRiseMixedUse	682	640	644	635	663	625	614	614	617	620	632	632	628	627	595	641
HighRiseMixedUse	586	562	564	559	576	552	545	546	547	549	557	557	555	553	534	561

Table 34: Annual LSC Savings (kBtu) Per Dwelling Unit by Climate Zone (CZ) – Gas-AppM

Prototype	CZ 1	CZ 2	CZ 3	CZ 4	CZ 5	CZ 6	CZ 7	CZ 8	CZ 9	CZ 10	CZ 11	CZ 12	CZ 13	CZ 14	CZ 15	CZ 16
LowRiseGarden	343	312	313	309	330	305	300	297	298	302	307	306	304	306	281	317
LoadedCorridor	987	953	956	949	972	945	939	936	938	941	947	947	943	947	918	958
MidRiseMixedUse	899	843	849	837	875	831	821	816	820	824	834	834	829	833	790	851
HighRiseMixedUse	773	740	743	736	758	733	728	724	726	729	734	734	731	734	709	745

3.4 Cost and Cost-Effectiveness

3.4.1 Energy Cost Savings Methodology

Energy cost savings were calculated by applying the LSC hourly factors to the energy savings estimates that were derived using the methodology described in Section 3.3.1. LSC hourly factors are a normalized metric to calculate energy cost savings that accounts for the variable cost of electricity and natural gas for each hour of the year, along with how costs are expected to change over the period of analysis. In this case, the period of analysis used is 30 years.

The CEC requested energy cost savings over the 30-year period of analysis in both 2026 PV\$ and nominal dollars. The cost-effectiveness analysis uses LSC values in 2026 PV\$. Costs and cost-effectiveness using 2026 PV\$ are presented in Section 3.4.5 of this report. The CEC uses results in nominal dollars to complete the Economic and Fiscal Impacts Statement (From 399) for the entire package of proposed change to Title 24, Part 6. Appendix G: Energy Cost Savings in Nominal Dollars presents LSC savings results in nominal dollars.

This proposed code change does not apply to additions and/or alterations.

3.4.2 Energy Cost Savings Results

Per-unit energy cost savings for newly constructed buildings that are realized over the 30-year period of analysis are presented 2026 PV\$ in Table 35 through Table 42.

The LSC hourly factors methodology allows peak electricity savings to be valued more than electricity savings during non-peak periods. This measure addresses energy savings both during peak and non-peak hours.

Any time code changes impact cost, there is potential to disproportionately impact DIPs. Refer to Section 3.6 for more details addressing energy equity and environmental justice.

Table 35: Present Value LSC Savings Per Dwelling Unit Over 30-Year Period of Analysis – New Construction & Additions – LowRiseGarden – HPWH-AppM

Climate Zone	30-Year LSC Electricity Savings (2026 PV \$)	30-Year LSC Gas Savings (2026 PV \$)	Total 30-Year LSC Savings (2026 PV \$)
1	\$456	\$0	\$456
2	\$415	\$0	\$415
3	\$416	\$0	\$416
4	\$408	\$0	\$408
5	\$437	\$0	\$437
6	\$405	\$0	\$405
7	\$393	\$0	\$393
8	\$393	\$0	\$393
9	\$395	\$0	\$395
10	\$399	\$0	\$399
11	\$405	\$0	\$405
12	\$405	\$0	\$405
13	\$401	\$0	\$401
14	\$405	\$0	\$405
15	\$374	\$0	\$374
16	\$422	\$0	\$422

Table 36: Present Value LSC Savings Per Dwelling Unit Over 30-Year Period of Analysis – New Construction & Additions – LoadedCorridor – HPWH-AppM

Climate Zone	30-Year LSC Electricity Savings (2026 PV \$)	30-Year LSC Gas Savings (2026 PV \$)	Total 30-Year LSC Savings (2026 PV \$)
1	\$778	\$0	\$778
2	\$735	\$0	\$735
3	\$738	\$0	\$738
4	\$727	\$0	\$727
5	\$759	\$0	\$759
6	\$725	\$0	\$725
7	\$707	\$0	\$707
8	\$711	\$0	\$711
9	\$713	\$0	\$713
10	\$717	\$0	\$717
11	\$724	\$0	\$724
12	\$724	\$0	\$724
13	\$720	\$0	\$720
14	\$724	\$0	\$724
15	\$688	\$0	\$688
16	\$743	\$0	\$743

Table 37: Present Value LSC Savings Per Dwelling Unit Over 30-Year Period of Analysis – New Construction & Additions – MidRiseMixedUse – HPWH-AppM

Climate Zone	30-Year LSC Electricity Savings (2026 PV \$)	30-Year LSC Gas Savings (2026 PV \$)	Total 30-Year LSC Savings (2026 PV \$)
1	\$924	\$0	\$924
2	\$850	\$0	\$850
3	\$857	\$0	\$857
4	\$838	\$0	\$838
5	\$890	\$0	\$890
6	\$832	\$0	\$832
7	\$809	\$0	\$809
8	\$810	\$0	\$810
9	\$815	\$0	\$815
10	\$820	\$0	\$820
11	\$832	\$0	\$832
12	\$833	\$0	\$833
13	\$825	\$0	\$825
14	\$831	\$0	\$831
15	\$774	\$0	\$774
16	\$862	\$0	\$862

Table 38: Present Value LSC Savings Per Dwelling Unit Over 30-Year Period of Analysis – New Construction & Additions – HighRiseMixedUse – HPWH-AppM

Climate Zone	30-Year LSC Electricity Savings (2026 PV \$)	30-Year LSC Gas Savings (2026 PV \$)	Total 30-Year LSC Savings (2026 PV \$)
1	\$593	\$0	\$593
2	\$550	\$0	\$550
3	\$554	\$0	\$554
4	\$542	\$0	\$542
5	\$573	\$0	\$573
6	\$539	\$0	\$539
7	\$525	\$0	\$525
8	\$526	\$0	\$526
9	\$529	\$0	\$529
10	\$532	\$0	\$532
11	\$539	\$0	\$539
12	\$540	\$0	\$540
13	\$535	\$0	\$535
14	\$538	\$0	\$538
15	\$505	\$0	\$505
16	\$557	\$0	\$557

Table 39: 2026 Present Value LSC Savings Per Dwelling Unit Over 30-Year Period of Analysis – New Construction & Additions – LowRiseGarden – Gas-AppM

Climate Zone	30-Year LSC Electricity Savings (2026 PV \$)	30-Year LSC Gas Savings (2026 PV \$)	Total 30-Year LSC Savings (2026 PV \$)
1	\$0	\$343	\$343
2	\$0	\$312	\$312
3	\$0	\$313	\$313
4	\$0	\$309	\$309
5	\$0	\$330	\$330
6	\$0	\$305	\$305
7	\$0	\$300	\$300
8	\$0	\$297	\$297
9	\$0	\$298	\$298
10	\$0	\$302	\$302
11	\$0	\$307	\$307
12	\$0	\$306	\$306
13	\$0	\$304	\$304
14	\$0	\$306	\$306
15	\$0	\$281	\$281
16	\$0	\$317	\$317

Table 40: 2026 Present Value LSC Savings Per Dwelling Unit Over 30-Year Period of Analysis – New Construction & Additions – LoadedCorridor – Gas-AppM

Climate Zone	30-Year LSC Electricity Savings (2026 PV \$)	30-Year LSC Gas Savings (2026 PV \$)	Total 30-Year LSC Savings (2026 PV \$)
1	\$0	\$987	\$987
2	\$0	\$953	\$953
3	\$0	\$956	\$956
4	\$0	\$949	\$949
5	\$0	\$972	\$972
6	\$0	\$945	\$945
7	\$0	\$939	\$939
8	\$0	\$936	\$936
9	\$0	\$938	\$938
10	\$0	\$941	\$941
11	\$0	\$947	\$947
12	\$0	\$947	\$947
13	\$0	\$943	\$943
14	\$0	\$947	\$947
15	\$0	\$918	\$918
16	\$0	\$958	\$958

Table 41: 2026 Present Value LSC Savings Per Dwelling Unit Over 30-Year Period of Analysis – New Construction & Additions – MidRiseMixedUse – Gas-AppM

Climate Zone	30-Year LSC Electricity Savings (2026 PV \$)	30-Year LSC Gas Savings (2026 PV \$)	Total 30-Year LSC Savings (2026 PV \$)
01	\$0	\$899	\$899
02	\$0	\$843	\$843
03	\$0	\$849	\$849
04	\$0	\$837	\$837
05	\$0	\$875	\$875
06	\$0	\$831	\$831
07	\$0	\$821	\$821
08	\$0	\$816	\$816
09	\$0	\$820	\$820
10	\$0	\$824	\$824
11	\$0	\$834	\$834
12	\$0	\$834	\$834
13	\$0	\$829	\$829
14	\$0	\$833	\$833
15	\$0	\$790	\$790
16	\$0	\$851	\$851

Table 42: 2026 Present Value LSC Savings Per Dwelling Unit Over 30-Year Period of Analysis – New Construction & Additions – HighRiseMixedUse – Gas-AppM

Climate Zone	30-Year LSC Electricity Savings (2026 PV \$)	30-Year LSC Gas Savings (2026 PV \$)	Total 30-Year LSC Savings (2026 PV \$)
01	\$0	\$773	\$773
02	\$0	\$740	\$740
03	\$0	\$743	\$743
04	\$0	\$736	\$736
05	\$0	\$758	\$758
06	\$0	\$733	\$733
07	\$0	\$728	\$728
08	\$0	\$724	\$724
09	\$0	\$726	\$726
10	\$0	\$729	\$729
11	\$0	\$734	\$734
12	\$0	\$734	\$734
13	\$0	\$731	\$731
14	\$0	\$734	\$734
15	\$0	\$709	\$709
16	\$0	\$745	\$745

3.4.3 Incremental First Cost

Incremental first cost is the initial cost to adopt more efficient equipment or building practices as compared to the cost of an equivalent baseline project. The Statewide CASE Team considers first costs in evaluating overall measure Cost-Effectiveness. Incremental first costs are based on data currently available and can change over time as markets evolve and professionals become familiar with new technology and building practices.

The Statewide CASE Team developed a basis of design for each prototype, described in Section 3.3.1.2, and they worked with two mechanical contractors to estimate costs for each, the basis of design, and the proposed case. Upon thorough review of the data provided by both contractors, the data from one contractor was removed from the analysis, because the costs provided by that contractor did not align with the intent of the measure and the specifications provided. Additionally, the data provided by the contractor that was used for analysis went through an extensive quality control process and discrepancies were reviewed and rectified if necessary.

The mechanical contractor provided material and labor cost estimates for complete installation of the cold and hot water distribution piping, heating plant piping and associated appurtenances, fittings with all the piping, general conditions and overhead, design and engineering, permit, testing, and inspection, and a contractor profit or market factor.

The Statewide CASE Team designed cold and hot water distribution systems and hot water heating plant plumbing systems for each of the prototype buildings according to CPC Appendix A (base case) and CPC Appendix M (proposed case). Based on the plumbing designs, the Statewide CASE Team calculated the total length of pipe for each pipe size for each prototype building in the base case and the proposed case for the cold and hot water distribution systems. The Statewide CASE Team calculated the total length of piping at the heating plant (for both gas and heat pump water heating) and equivalent length of appurtenances and fittings (based on an estimated straight pipe heat loss contribution) on the piping and affixed to the storage tanks at the heating plant. These design drawings and piping calculations are detailed in Appendix I. Table 43 gives the total length of each pipe size for the cold and hot water distribution piping and hot water piping for the two types of heating plants for each of the prototype buildings: base case and proposed.

Table 43: Total Length (Feet) of Each Pipe Size for CPC Appendix A Base Case and Appendix M Proposed Case Design

System	Pipe Size	Low-Rise Garden: Base	Low-Rise Garden: Proposed	Low-Rise Loaded Corridor: Base	Low-Rise Loaded Corridor: Proposed	Mid-Rise Mixed Use: Base	Mid-Rise Mixed Use: Proposed	High-Rise Mixed Use: Base	High-Rise Mixed Use: Proposed
Cold Distribution	0.5"	0	0	0	0	0	0	0	0
	0.75"	54	141	135	456	200	1160	260	1326
	1"	29	23	154	131	220	139	260	226
	1.25"	26	0	119	18	720	161	598	4
	1.5"	32	0	48	0	81	68	227	0
	2"	23	0	59	0	115	0	160	93
	2.5"	0	0	72	0	66	0	47	0
	3"	0	0	18	0	107	0	54	0
	4"	0	0	0	0	19	0	43	0
Hot Distribution	0.5"	0	0	0	0	0	0	0	0
	0.75"	168	168	449	449	744	724	1018	1018
	1"	29	55	182	287	338	1158	313	1095
	1.25"	0	0	0	0	0	0	0	0
	1.5"	58	52	153	107	939	254	782	148
	2"	20	0	24	80	85	66	58	80
	2.5"	0	0	90	0	73	121	165	129
	3"	0	0	25	0	91	0	130	5
	4"	0	0	0	0	53	0	9	0
Gas Plant	0.5"	0	0	0	0	0	0	0	0
	0.75"	12	12	0	0	0	0	0	0
	1"	0	0	12	12	0	0	24	24
	1.5"	36	36	0	0	0	0	0	0
	2"	44	44	36	86	12	12	24	24
	2.5"	0	0	0	0	0	0	0	0
	3"	0	0	62	12	48	116	36	76
	4"	0	0	0	0	68	0	52	12
	5"	0	0	0	0	0	0	0	48
	6"	0	0	0	0	0	0	48	48

System	Pipe Size	Low-Rise Garden: Base	Low-Rise Garden: Proposed	Low-Rise Loaded Corridor: Base	Low-Rise Loaded Corridor: Proposed	Mid-Rise Mixed Use: Base	Mid-Rise Mixed Use: Proposed	High-Rise Mixed Use: Base	High-Rise Mixed Use: Proposed
HPWH Plant	0.5"	24	24	48	48	0	0	0	0
	0.75"	12	12	12	12	0	0	0	0
	1"	0	0	12	12	24	24	48	48
	1.5"	12	12	0	0	12	12	12	12
	2"	56	56	12	68	12	12	24	24
	2.5"	0	0	0	0	0	0	0	0
	3"	0	0	56	0	12	80	0	64
	4"	0	0	0	0	68	0	64	0
	5"	0	0	0	0	0	0	0	0
	6"	0	0	0	0	0	0	36	36
System Totals Gas	All	531	531	1638	1638	3979	3979	4308	4356
System Totals HPWH	All	543	543	1668	1668	3979	3979	4308	4308

The Statewide CASE Team analyzed piping material and appurtenance costs and labor hours from one of two mechanical contractor, as shown in Table 44 and Table 45. After a thorough market cost review of the costs received by both contractors, it was determined by the Statewide CASE Team that one of the contractors prices were not reasonable and was dropped from consideration. The material costs include the piping, pipe insulation, associated appurtenances, piping supports, and other installation materials. The labor hours are those to install all plumbing components. The mechanical contractor provided a labor rate of \$95 per hour.

The Statewide CASE Team calculated the total piping insulation costs for Appendix A and Appendix M by leveraging costs provided by our contractor for the insulation enhancement measure to meet existing insulation code requirements. The insulation pricing the Statewide CASE Team received was in dollars per foot, and it included labor. The Statewide CASE Team opted to use a 50/50 material and labor split when calculating hot water piping insulation costs for Appendix A and Appendix M. The insulation costs are included in the values shown in Table 44 and Table 45 column “Pipe and Insulation Cost” below.

Using the pipe lengths in Table 43 and the piping costs in Table 44 and Table 45, the Statewide CASE Team calculated the total piping costs in the base case and the proposed case for each prototype building also shown in Table 44 and Table 45.

Table 44: Material and Labor Costs (Gas Plant)

MF Building Type	Case	Pipe and Insulation Material Cost	Appurtenances Material Cost	Labor Hours	Labor Rate	Total
Low-Rise Garden Style	Base Case	\$9,535	\$10,625	156	\$95	\$35,008
	Proposed Case	\$8,495	\$10,365	154	\$95	\$33,456
Low-Rise Loaded Corridor	Base Case	\$32,906	\$25,930	387	\$95	\$95,611
	Proposed Case	\$24,549	\$16,600	346	\$95	\$74,050
Mid-Rise Mixed Use	Base Case	\$89,335	\$71,085	870	\$95	\$243,104
	Proposed Case	\$61,909	\$41,440	754	\$95	\$174,954
High-Rise Mixed Use	Base Case	\$98,055	\$125,530	940	\$95	\$312,864
	Proposed Case	\$73,131	\$97,890	834	\$95	\$250,294

Table 45: Material and Labor Costs (HPWH Plant)

MF Building Type	Case	Pipe and Insulation Material Cost	Appurtenances Material Cost	Labor Hours	Labor Rate	Total
Low-Rise Garden Style	Base Case	\$9,518	\$9,465	155	\$95	\$33,710
	Proposed Case	\$8,485	\$9,181	136	\$95	\$30,578
Low-Rise Loaded Corridor	Base Case	\$32,558	\$20,325	388	\$95	\$89,778
	Proposed Case	\$24,183	\$13,135	329	\$95	\$68,601
Mid-Rise Mixed Use	Base Case	\$88,006	\$43,460	859	\$95	\$213,025
	Proposed Case	\$60,702	\$24,962	728	\$95	\$154,788
High-Rise Mixed Use	Base Case	\$95,791	\$61,720	927	\$95	\$245,603
	Proposed Case	\$69,783	\$46,504	789	\$95	\$191,238

Table 46 and Table 47 show for the proposed measure, the total incremental cost, and incremental cost per dwelling unit for each building type. This proposed measure is unique as there is no incremental cost, but rather incremental cost savings since the proposed measure costs less than base case. This is because CPC Appendix M (proposed case) often leads to smaller pipe sizes than CPC Appendix A (base case), the proposed case has a lower cost than the base case for all prototype buildings.

Table 46: Incremental Cost Per Prototype - Gas-AppM

MF Building Type	Gas-AppM Base Case	Gas-AppM Proposed Case	Gas-AppM Total Incremental Cost Savings	Gas-AppM Average Incremental Cost Savings per Dwelling Unit
Low-Rise Garden	\$34,936	\$33,427	-\$1,510	-\$189
Low-Rise Loaded Corridor	\$95,051	\$74,044	-\$21,007	-\$584
Mid-Rise Mixed Use	\$240,630	\$174,346	-\$66,284	-\$753
High-Rise Mixed Use	\$308,021	\$247,179	-\$60,841	-\$520

Table 47: Incremental Cost Per Prototype - HPWH-AppM

MF Building Type	HPWH-AppM Base Case	HPWH-AppM Proposed Case	HPWH-AppM Total Incremental Cost Savings	HPWH-AppM Average Incremental Cost Savings per Dwelling Unit
Low-Rise Garden	\$33,682	\$30,511	-\$3,172	-\$396
Low-Rise Loaded Corridor	\$89,481	\$68,673	-\$20,808	-\$578
Mid-Rise Mixed Use	\$211,739	\$154,810	-\$56,930	-\$647
High-Rise Mixed Use	\$243,546	\$190,251	-\$53,294	-\$456

3.4.4 Incremental Maintenance and Replacement Costs

Incremental maintenance cost is the incremental cost of replacing the equipment or parts of the equipment, as well as periodic maintenance required to keep the equipment operating relative to current practices over the 30-year period of analysis. There are no replacement costs for the proposed measure because the expected useful life of the measure and the impacted equipment is longer than the period of analysis. The periodic maintenance costs for the proposed measure are the same as for the base case; therefore, there are no associated incremental costs.

3.4.5 Cost-Effectiveness

This measure proposes a primary prescriptive requirement. As such, a cost analysis is required to demonstrate that the measure is cost effective over the 30-year period of analysis.

The CEC establishes the procedures for calculating Cost-Effectiveness. The Statewide CASE Team collaborated with CEC staff to confirm that the methodology in this report is consistent with their guidelines, including which costs were included in the analysis. The incremental first cost and incremental maintenance costs over the 30-year period of analysis were included. The LSC savings from electricity and natural gas savings were also included in the evaluation. Design costs were not included nor were the incremental costs of code compliance verification.

According to the CEC's definitions, a measure is cost effective if the B/C ratio is greater than 1.0. The B/C ratio is calculated by dividing the cost benefits realized over 30 years by the total incremental costs, which includes maintenance costs for 30 years. The B/C ratio was calculated using 2026 PV costs and cost savings. Benefits and costs are defined as follows:

- **Benefits: 30-year LSC Savings + Other PV Savings:** Benefits include LSC savings over the 30-year period of analysis (California Energy Commission 2022). Other savings are discounted at a real (nominal – inflation) three percent rate. Other PV savings include incremental first-cost savings if proposed first cost is less than current first cost, incremental PV maintenance cost savings if PV of proposed maintenance costs is less than PV of current maintenance costs, and incremental residual value if proposed residual value is greater than current residual value at end of CASE analysis period.
- **Costs: Total Incremental Present Valued Costs:** Costs include incremental equipment, replacement, and maintenance costs over the period of analysis if PV of proposed costs is greater than PV of current costs. Costs are discounted at a real (inflation-adjusted) three percent rate. If incremental maintenance cost is

negative, it is treated as a positive benefit. If there are no total incremental PV costs, the B/C ratio is infinite.

Results of the per-unit, cost-effectiveness analyses are presented in Table 48 and Table 49 for new construction. This measure is cost effective since the B/C ratio is greater than 1 in all cases.

Table 48: 30-Year Cost-Effectiveness Summary Per Dwelling Unit – New Construction – HPWH-AppM

Climate Zone	Benefits: LSC Savings + Other PV Cost Savings (2026 PV\$/dwelling unit)	Costs: Total Incremental PV Costs (2026 PV\$/dwelling unit)	B/C Ratio
1	\$1,410	\$0	Infinite
2	\$1,408	\$0	Infinite
3	\$1,402	\$0	Infinite
4	\$1,408	\$0	Infinite
5	\$1,464	\$0	Infinite
6	\$1,357	\$0	Infinite
7	\$1,349	\$0	Infinite
8	\$1,329	\$0	Infinite
9	\$1,328	\$0	Infinite
10	\$1,342	\$0	Infinite
11	\$1,355	\$0	Infinite
12	\$1,376	\$0	Infinite
13	\$1,368	\$0	Infinite
14	\$1,332	\$0	Infinite
15	\$1,285	\$0	Infinite
16	\$1,365	\$0	Infinite
Total	\$1,358	\$0	Infinite

Table 49: 30-Year Cost-Effectiveness Summary Per Dwelling Unit - New Construction – Additions - Gas-AppM

Climate Zone	Benefits: LSC Savings + Other PV Cost Savings (2026 PV\$/dwelling unit)	Costs: Total Incremental PV Costs (2026 PV\$/dwelling unit)	B/C Ratio
1	\$1,544	\$0	Infinite
2	\$1,544	\$0	Infinite
3	\$1,546	\$0	Infinite
4	\$1,554	\$0	Infinite
5	\$1,603	\$0	Infinite
6	\$1,514	\$0	Infinite
7	\$1,522	\$0	Infinite
8	\$1,490	\$0	Infinite
9	\$1,488	\$0	Infinite
10	\$1,503	\$0	Infinite
11	\$1,513	\$0	Infinite
12	\$1,537	\$0	Infinite
13	\$1,531	\$0	Infinite
14	\$1,487	\$0	Infinite
15	\$1,451	\$0	Infinite
16	\$1,507	\$0	Infinite
Total	\$1,515	\$0	Infinite

3.5 Annual Statewide Impacts

3.5.1 Statewide Energy and Energy Cost Savings

The Statewide CASE Team calculated the first-year statewide savings for new construction by multiplying the per-unit savings (which are presented in Section 3.3.2) by assumptions about the percentage of newly constructed buildings that would be impacted by the proposed code. The statewide new construction forecast for 2026 is presented in Appendix A, as are the Statewide CASE Team’s assumptions about the percentage of new construction that would be impacted by the proposal (by climate zone and building type).

The first-year energy impacts represent the first-year annual savings from all buildings that were completed in 2026. The 30-year energy cost savings represent the energy cost savings over the entire 30-year analysis period. The statewide savings estimates do not take naturally occurring market adoption or compliance rates into account.

The tables below present the first-year statewide energy and energy cost savings from newly constructed buildings (Table 50) by climate zone.

While a statewide analysis is crucial to understanding broader effects of code change proposals, there is potential to disproportionately impact DIPs that needs to be considered. Refer to Section 3.6 for more details addressing energy equity and environmental justice.

Table 50: Statewide Energy and Energy Cost Impacts – New Construction – AppM

Climate Zone	Statewide New Construction Impacted by Proposed Change in 2026 (Dwelling Units)	Annual ^a Electricity Savings (GWh)	Annual Peak Electrical Demand Reduction (MW)	Annual Natural Gas Savings (Million Therms)	Annual Source Energy Savings (Million kBtu)	30-Year Present Valued LSC Savings (Million 2026 PV\$)
1	96	0.00	0.00	0.00	0.06	\$0.09
2	923	0.02	0.00	0.01	0.53	\$0.78
3	5,110	0.10	0.01	0.03	2.95	\$4.34
4	2,268	0.04	0.01	0.01	1.29	\$1.90
5	189	0.00	0.00	0.00	0.11	\$0.16
6	1,489	0.03	0.00	0.01	0.84	\$1.24
7	3,422	0.06	0.01	0.02	1.90	\$2.82
8	5,708	0.11	0.01	0.03	3.17	\$4.68
9	6,837	0.13	0.02	0.04	3.81	\$5.63
10	2,858	0.05	0.01	0.02	1.60	\$2.36
11	779	0.02	0.00	0.00	0.44	\$0.65
12	3,675	0.07	0.01	0.02	2.09	\$3.07
13	670	0.01	0.00	0.00	0.38	\$0.56
14	960	0.02	0.00	0.01	0.54	\$0.80
15	248	0.00	0.00	0.00	0.13	\$0.20
16	124	0.00	0.00	0.00	0.07	\$0.11
Total	35,354	0.68	0.08	0.21	19.9	\$29.4

a. First-year savings from all buildings completed statewide in 2026.

3.5.2 Statewide GHG Emissions Reductions

The Statewide CASE Team calculated avoided GHG emissions associated with energy consumption using the hourly GHG emissions factors that the CEC developed along with the 2025 LSC hourly factors and an assumed cost of \$123.15 per metric ton of carbon dioxide equivalent emissions (metric tons CO₂e).

The monetary value of avoided GHG emissions is based on a proxy for permit costs (not social costs).²¹ The cost-effectiveness analysis presented in Section 3.4.5 of this report does not include the cost savings from avoided GHG emissions. To demonstrate the cost savings of avoided GHG emissions, the Statewide CASE Team disaggregated the value of avoided GHG emissions from the other economic impacts.

Table 51 presents the estimated first-year avoided GHG emissions of the proposed code change. During the first year, GHG emissions of 1,310 metric tons CO₂e would be avoided.

Table 51: Annual Statewide GHG Emissions Impacts – CPC Appendix M

Measure	Electricity Savings ^a (GWh/yr)	Reduced GHG Emissions from Electricity Savings ^a (Metric Tons CO ₂ e)	Natural Gas Savings ^a (Million Therms/yr)	Reduced GHG Emissions from Natural Gas Savings ^a (Metric Tons CO ₂ e)	Total Reduced GHG Emissions ^b (Metric Ton CO ₂ e)	Total Monetary Value of Reduced GHG Emissions ^c (\$)
CPC Appendix M	0.68	62.9	0.21	1,247	1,310	\$161,336

- First-year savings from all applicable newly constructed buildings, additions, and alterations completed statewide in 2026.
- GHG emissions savings were calculated using hourly GHG emissions factors alongside the LSC hourly factors published by the CEC here: <https://www.energy.ca.gov/files/2025-energy-code-hourly-factors>
- The monetary value of avoided GHG emissions is based on a proxy for permit costs (not social costs) derived from the TDV Update Model by CEC here: <https://www.energy.ca.gov/files/tdv-2022-update-model>

3.5.3 Statewide Water Use Impacts

Impacts on water use are presented in Table 52. The average dwelling unit when weighted for the four prototype buildings would save 264 gallons per year from an improvement in hot water delivery time associated with using skinnier hot water distribution piping. Annual water and embedded energy savings for each prototype per dwelling unit is provided in Appendix B. It was assumed that all water savings occurred indoors, and the embedded electricity value was 5,440 kWh/million gallons of water. The embedded electricity estimate was derived from a 2022 research analysis conducted under the auspices of California Public Utility Commission (CPUC) Rulemaking 13-12-011 that quantified the embedded electricity savings from IOU

²¹ The permit cost of carbon is equivalent to the market value of a unit of GHG emissions in the California Cap-and-Trade program, while social cost of carbon is an estimate of the total economic value of damage done per unit of GHG emissions. Social costs tend to be greater than permit costs. See more on the Cap-and-Trade Program on the California Air Resources Board website: <https://ww2.arb.ca.gov/our-work/programs/cap-and-trade-program>.

programs that save both water and energy (SBW Consulting, Inc. 2022). See Appendix B for additional information on the embedded electricity savings estimates.

Table 52: Impacts on Water Use and Embedded Electricity in Water – CPC Appendix M

Impact	On-Site Indoor Water Savings (Gallons/Year)	Embedded Electricity Savings ^a (kWh/Year)
Average Per Dwelling Unit Impacts	263	1.4
Annual^b Statewide Impacts for New Construction & Additions	9,296,024	50,505
Annual^b Statewide Impacts for Alterations	-	-
Annual^b Total Statewide Impacts	9,296,024	50,505

- a. Assumes embedded energy factor of 5,440 kWh per million gallons of water for indoor use (SBW Consulting, Inc. 2022).
- b. First-year savings from all buildings completed statewide in 2026.

For more details involving water use and water impacts quality, refer to Appendix B.

3.5.4 Statewide Material Impacts

The code proposal shows the reduction in the pipe diameter for this measure which resulted in savings in copper usage. The impact would be different for heat pump water heating plants compared to gas heating plants and thus both the impacts are shown in the following tables. See Appendix D for more details.

Table 53: Annual Statewide Impacts on Material Use – HPWH – CPC Appendix M

Material	Impact	Per-Unit Impacts (Pounds per Dwelling Unit)	Annual ^a Statewide Impacts (Pounds)
Copper	Decrease	9.8	512,165
Others (Insulation)	Decrease	54.4	2,900,074
TOTAL	–	–	–

- a. First-year savings from all buildings completed statewide in 2026.

Table 54: Annual Statewide Impacts on Material Use – Gas – CPC Appendix M

Material	Impact	Per-Unit Impacts (Pounds per Dwelling Unit)	Annual ^a Statewide Impacts (Pounds)
Copper	Decrease	9.9	528,158
Others (Insulation)	Decrease	55.3	2,947,303
TOTAL	–	–	–

- a. First-year savings from all buildings completed statewide in 2026.

3.5.5 Other Non-Energy Impacts

There is no non-energy impact for this measure.

3.6 Addressing Energy Equity and Environmental Justice

The Statewide CASE Team assessed the potential impacts of the proposed measure on DIPs. See Section 2 for a summary of research methods and potentially impacted populations, as well as other general potential equity impacts (CALEPA 2022).

3.6.1 Potential Impacts

This measure would result in lower construction costs, a reduction in energy costs, and improved hot water delivery performance, which are discussed in detail in section 2.2.2, with impacts on potentially impacted populations as described in section 2.2.1

4. Pipe Insulation Enhancement

4.1 Measure Description

4.1.1 Proposed Code Change

Pipe insulation enhancement is a combination of code language cleanup and field verification. The first component investigates the mandatory pipe insulation requirements contained under Title 24, Part 6, Section 160.4 for possible cleanup. Requirements for pipe insulation thickness in multifamily DHW systems are clearly articulated, but it is unclear whether the requirements extend to insulating the heating plant, appurtenances in series with the recirculation loop such as pipe supports, check valves, mixing valves, balancing valves, strainers, flanges, air separators, water pumps, and monitoring sensors and equipment. The main intention of this cleanup measure is to ensure uniform insulation of the heating plant, recirculation loop, and branches to the dwelling units. The Statewide CASE Team proposes cleanup language to define the types of appurtenances, appurtenance specific requirements (such as requiring the use of extended stem isolation valves and removeable and re-installable insulation), and pipe insulation thickness requirements. The proposed code change codifies pipe insulation installation best practices such as sealing seams and cutting insulation properly for fittings.

The second component is a mandatory requirement for field verification that would confirm installation of code required pipe insulation and overall insulation installation quality. Field verification would confirm installation of code required pipe insulation, including insulation on all fittings and valves, pumps, thermal isolation at pipe hangers, and overall insulation installation quality. Field verification would require minor updates to default values for derating insulation quality in the compliance software. This submeasure builds on the current single family and low-rise multifamily residential pipe insulation inspection credit (PIC-H) and extends it to become a mandatory requirement for all multifamily buildings with DWH recirculation systems. This submeasure includes minor updates to default values for derating insulation quality in the compliance software.

This mandatory code change and code language cleanup proposal would apply to newly constructed buildings only. The measures would add field verification, but no acceptance tests. The proposal would require minor updates to the compliance software.

4.1.2 Justification and Background Information

4.1.2.1 Justification

The current multifamily mandatory pipe insulation code language does not include key details of what type of DHW system piping shall be insulated or if appurtenances and pipe support require proper insulation. Adding a comprehensive, mandatory requirement in the code language, including explicitly naming components that would require insulation, would provide clarity to the design and installation industry to ensure heating plants, recirculation loops, and branch piping are insulated to minimize pipe heat loss. Clear insulation language and uniform insulation requirements would streamline the field verification process.

Field verification of pipe insulation installation quality would ensure uniform building industry installation practices and minimize pipe heat loss for the effective useful life of the distribution system. The pipe insulation verification submeasure stems from the poor quality of existing insulation exhibited by the 2013 PIER Report “Multifamily Central Domestic Hot Water Distribution Systems” (PIER 2013) and the 2022 Statewide CASE Team data collection, including stakeholder feedback during the CASE process. This submeasure is similar in scope and mechanism to the existing multifamily quality insulation installation (QII) energy credit through home energy rating system (HERS) or acceptance test technician (ATT) verification and would apply to multifamily buildings with DHW recirculation systems.

4.1.2.2 Background Information

Pipe Insulation Code Language

The mandatory insulation code language for multifamily buildings was consolidated in 2022 Title 24, Part 6 Section 160.4 from Section 150.0 of the 2019 low-rise residential code and Section 120.3 of the nonresidential/high-rise multifamily code. A significant portion of the 120.3 general requirements for pipe insulation code language was unintentionally omitted from 160.4 and is now limited to one sentence that reads, “*Piping for multifamily domestic hot water systems, shall be insulated to meet the requirements of Table 160.4-A*”. Similarly, pipe insulation language in Section 150.0 was significantly edited to reference the CPC, which greatly limited the portions of piping that must be insulated. Where appropriate in this report, The Statewide CASE Team would explain the history of Section 120.3, of which Section 160.4 is derived to demonstrate the unclear and uneven pipe insulation language currently in the code and followed by the construction industry.

In the 2019 Title 24, Part 6, Section 120.3, the code language was expanded to include an expanded section on HVAC pipe insulation that included “Fluid distribution systems, insulating elements that are in series with the fluid flow, such as pipes, pumps, valves,

strainers...” The Statewide CASE Team uses the term “appurtenances” to describe these pipe components for DHW systems for this proposal. In the 2016 code update cycle, language was added to Section 120.3 for DHW insulation that included requirements for insulating the recirculation system piping, the first eight feet of hot and cold outlet piping and externally heated pipes, but there was no mention of insulating DHW system appurtenances. The 2019 version of Section 120.3 adds insulation language of elements in series of fluid distribution systems for space cooling and heating systems that aligns with the 2019 American Society of Heating, Refrigerating and Air-Conditioning Engineers (ASHRAE) 90.1 *Energy Standard for Sites and Buildings Except Low-Rise Residential Buildings* to a greater extent than 2016 by being more explicit and expansive with HVAC pipe insulation requirements and limited with DHW requirements.

ASHRAE 90.1 contains pipe insulation language in Section 7.4.3 for DHW systems and Section 6.4.4.1.3 for HVAC systems. Section 7.4.3 includes the same DHW insulation language as 120.3, and it additionally includes language that the first eight feet of branch piping connected to piping that carries recirculated water shall be insulated. Section 6.4.4.1.3 adds that “all piping associated with HVAC systems must be thermally insulated for heat and hot-water systems and for cooling, brine and refrigerant systems.” In the exceptions section it states that insulation is not regulated in the following cases that includes: “Strainers, control valves, and balancing valves in piping less than or equal to one inch in size. This allows for easy access to these devices.” This implies that “all piping” larger than 1” diameter, including some appurtenances such as strainers, control valves and balancing valves in series, must be thermally insulated for space conditioning systems. Section 7.4.3 does not have a similar requirement for DHW systems. Thus, for multifamily buildings, the existing 2022 Section 160.4 pipe insulation code language leaves a lot for interpretation, making it difficult for designers to give consistent direction to contractors and for inspectors to understand what to verify.

Currently, the most common practice for insulation contractors is to insulate hot water piping to the minimum insulation thickness required by code. The Statewide CASE Team’s interviews with designers revealed that they specify code minimum pipe insulation. Designers specify tees and elbows to be insulated as they are considered part of the pipe. However, isolation valves are insulated only occasionally.

Several designers stated that contractors routinely insulate nothing more than what the inspector would check, which is usually tees and elbows. One designer commented that they get pushback on additional pipe insulation requirements above code from contractors. One general contractor interviewed stated that they are unclear on Title 24, Part 6 pipe insulation requirements, and they ask the inspector for an interpretation of the code requirements prior to insulating the piping.

As well, the lack of pipe insulation language, or clear language, relating to appurtenances in ASHRAE 90.1 for DHW systems has influenced Title 24, Part 6

language. As a result, design requirements on project drawings and specifications are inconsistent and subject to interpretation.

Impact of Pipe Insulation on Hot Water System Efficiency

Photos of pipe insulation on buildings documented by the 2022 Statewide CASE Team often showed portions of pipes, fittings, valves, and pumps that are not insulated. This has a great impact on HPWH plants. The prevailing HPWH plant design is the single pass heat pump upstream in series with an electric resistance temperature maintenance swing tank. The latter tank's primary function is to heat the recirculation loop.

The best insulated distribution systems have a heat loss approaching 50 watts per dwelling unit. Research data shows that the median recirculation loop heat loss is approximately 100 watts per dwelling unit (Ecotope 2020). A poorly insulated recirculation loop can have a heat loss approaching 200 watts per dwelling unit. In a swing tank design, if the loop heat loss is excessive, the upstream HPWH is unable to provide sufficient hot water during draws from the primary tanks into the swing tank to keep the swing tank elevated above the 125°F setpoint for most of the 24-hour period. This inability to provide sufficient hot water causes prolonged electric resistance element activation, greatly reducing the COP of the system and increasing operating costs. Based on prior lab and field research, the Statewide CASE Team confirms that poor pipe insulation and lack of verification leads to excessive electric resistance used in central HPWH systems in a swing tank configuration and similarly causes inefficiency in gas-fired central water heating systems with additional heat loss caused by excessive tank destratification (Perachova 2019).

Pipe Insulation Field Verification

Title 24, Part 6 has no requirement for field verification, which would complement the proposed explicit pipe insulation cleanup language. The 2022 Statewide CASE Team investigated a pipe insulation verification measure. The CEC decided not to add or change the measure close to adoption, but a freeze on all measures that HERS verification requirements was added; therefore, this proposal did not move forward. Pipe insulation verification is needed and is being repropoed because of the poor quality of existing insulation exhibited by the 2013 PIER Report "Multifamily Central Domestic Hot Water Distribution Systems" (PIER 2013) and based on the Statewide CASE Team's interviews with design firms and stakeholder feedback during the 2022 CASE process. The following is an excerpt from the 2022 CASE DHW Distribution Report.

The 2013 PIER Study monitored several key parameters of central hot water systems including hot water supply temperature, hot water return temperature, cold-water supply temperature, recirculation flow, hot water draw flow, and natural gas consumption. The study monitored 28 buildings in five different climate zones in California. The PIER Study Team then developed an energy flow analysis model to separate DHW natural

gas consumption into four energy flow components: water heating equipment efficiency and standby heat loss, recirculation system heat loss, branch pipe heat loss, and delivered hot water energy. Recirculation system heat loss ranged from three to 67 percent of total hot water usage with an average of 33 percent. The study found that measured heat loss from DHW distribution piping was approximately twice the anticipated heat loss that would occur with perfect insulation.

Based on the PIER Study energy flow analysis model, the 2013 Statewide CASE Team developed two CASE Reports, one of which was the 2013 CASE Water and Space Heating ACM Improvement (Statewide CASE Team 2011). The 2013 Statewide CASE Team developed and proposed the performance calculation algorithms for recirculation systems in multifamily and hotel/motel buildings. The 2013 CASE Report suggested an ACM Reference Manual “correction factor to reflect imperfect insulation” that was adopted by the CEC and is part of the current Title 24, Part 6 performance approach. The current ACM Reference Manual includes this correction factor described as, “Correction factor to reflect imperfect insulation, insulation material degradation over time, and additional heat transfer through connected branch pipes that is not reflected in the branch heat loss calculation. It is assumed to be 2.0.”

In addition to the precedent for insulation modifications informed by the PIER study, the PIC-H Residential Verification described in Section RA3.6.2 of the residential appendices offers a compliance credit for HERS verification of pipe insulation quality. This credit is only available for trunk and branch distribution systems in single family and low-rise residential buildings. If this credit is achieved and the HERS Rater verifies the hot water distribution system is insulated according to CPC609.11, the project receives a 15 percent energy credit in the *assigned distribution system multiplier*, which is an adjustment for alternative water heating distribution systems within the dwelling unit.

The Statewide CASE Team also collected data on insulation quality through designer interviews, CASE stakeholder meeting surveys, construction managers and designers survey, and field observation punch lists²² and photos. A detailed summary of insulation quality data collection is contained in Section 4.2.2 and the methods and results are summarized below.

- **Designer interviews:** The Statewide CASE Team conducted interviews with six multifamily plumbing designers to garner feedback on recirculation design strategies, compliance, enforcement, and insulation quality. Insulation quality questions were open ended. Based on these interviews, the Statewide CASE Team learned that hot water distribution systems are frequently missing

²² A punch list is a document detailing items in a construction project that do not meet the specifications which must be addressed by the contractor.

insulation or have poorly installed insulation (missing insulation on fittings including improperly mitered joints, insulation not covering 100 percent of a straight pipe run, and overall poor insulation quality).

- **Utility-sponsored stakeholder meeting survey:** A survey was administered through the live Adobe interface during the first DHW Stakeholder meeting on October 4, 2019. Two questions were asked 1) “How often have you seen deficiencies in pipe insulation quality, such as missing insulation on fittings or poor-quality installation?” and 2) “What are the most common deficiencies in pipe insulation quality?” Ten out of the twelve respondents said that greater than 50 percent of projects have insulation deficiencies and that the typical deficiencies are “fittings are not insulated,” “pipe insulation is poorly installed (there are gaps),” and “valves are not insulated.”
- **Construction managers and designers survey:** The Statewide CASE Team asked several questions about interviewees’ observations of insulation quality in buildings where interviewees have participated in construction administration activities. The Statewide CASE Team found that insulation quality is lacking in 60-70 percent of multifamily buildings on average, and the most common issues are uninsulated piping specialties²³ including valves, tees, improperly mitered joints, and uninsulated pumps.
- **Field observation punch lists and photos:** The Statewide CASE Team collected field observation documentation from designers and construction managers. This data provides visual confirmation of the insulation quality issues found through interviews and surveys listed above. For example, Figure 2 shows missing insulation on elbow and tee fittings.



Figure 2: Field observation punch list photo showing missing pipe insulation.

Source: (AEA n.d.).

²³ Piping specialties refers to all components of a piping system other than the pipe itself.

In addition, the U.S. Department of Energy (U.S. DOE) identified the issue of missing elbow insulation in a 2012 Building Technologies Program Code Notes regarding insulation requirements in commercial buildings for mechanical and service hot water piping (U.S. DOE 2012). The publication includes the graphic illustration shown in Figure 3.

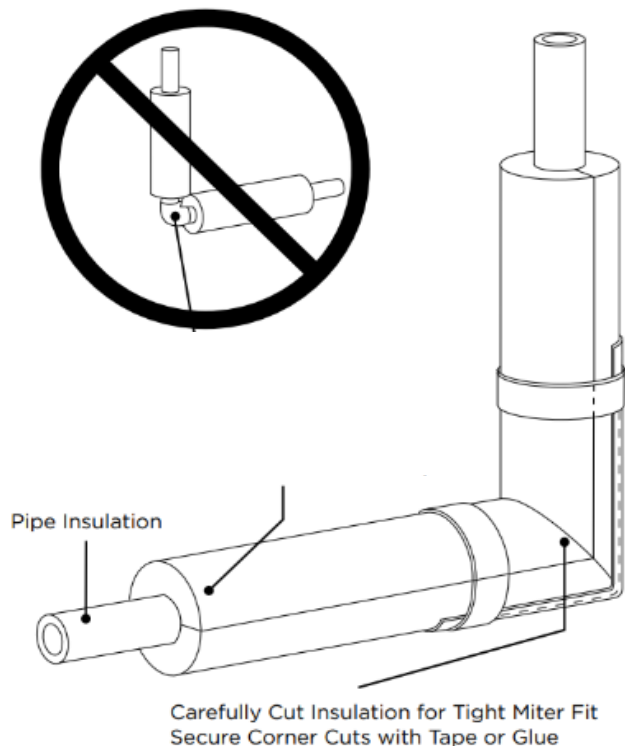

Figure 3: Illustration of improper and proper elbow insulation.

Source: (U.S. DOE 2012).

In summary, the proposed pipe insulation code language cleanup for 2025 Title 24, Part 6 Section 160.4 and pipe insulation quality installation verification would reduce pipe heat loss leading to heating plant energy use reduction by doing the following:

- Clarify that “All” piping for DHW systems shall be insulated including the first eight feet of inlet cold water piping to heating plant.
- Add new code language to ensure appurtenances at heating plants and supply and return loop must be insulated and insulation is removable and re-installable.
- Pipe supports, hangers, and clamps shall be attached on the outside of rigid pipe insulation.

- Address installation quality by ensuring all pipe insulation seams are sealed, specific insulation installation practices for tees and elbows are followed, and extended stem isolation valves used.
- Definition of hot water piping and plumbing appurtenances
- Add space cooling and heating pipe insulation language incorporated from Section 120.3
- Ensure accountability through third-party field verification of pipe insulation across the building design and construction industry, so continuous pipe insulation becomes standard practice and pipe insulation quality stays high moving forward.

4.1.3 Summary of Proposed Changes to Code Documents

The sections below summarize how the standards, Reference Appendices, ACM Reference Manuals, and compliance forms would be modified by the proposed change.²⁴ See Section 11 of this report for detailed proposed revisions to code language.

4.1.3.1 Specific Purpose and Necessity of Proposed Code Changes

Each proposed change to language in Title 24, Part 1 and Part 6 are described below. See Section 6.2 of this report for marked-up code language.

Section: 160.4(f)

Specific Purpose: Builds off this excerpt, “Piping for multifamily domestic hot water systems, shall be insulated to meet the requirements of Table 160.4-A.,” and adds new pipe insulation code language to establish continuous pipe insulation requirements to include appurtenances and pipe supports. The proposed code change would add language that requires HERS field verification of pipe insulation installation.

Necessity: These changes are necessary to articulate in detail the sections of piping including heating plants, branch piping, appurtenances, and pipe supports that require insulation to ensure consistency in design specification, as well as during installation and to streamline field verification process. The field verification addition is necessary to ensure quality installation of pipe insulation to reduce hot water pipe heat losses to increase energy efficiency via cost effective building design standards, as directed by California Public Resource Code Sections 25213 and 25402.

²⁴ Visit [EnergyCodeAce.com](https://www.energycodeace.com) for trainings, tools, and resources to help people understand existing code requirements.

This proposal would modify the sections of the Reference Appendices identified below. See Section 11.3 of this report for the detailed proposed revisions to the text of the Reference Appendices.

Reference Appendices

RA2.2 Measures that Require Field Verification and Diagnostic Testing

Table RA2-1 Summary of Measures Requiring Field Verification and Diagnostic Testing: The proposed new MMV default installation and commissioning instructions requirement would be added to the summary table under the Multifamily Domestic Hot Water Heating Measures heading.

RA3.6 Field Verification of Water Heating Systems

RA3.6.10 Hot Water Pipe Insulation Verification: The proposed change would add a new section RA3.6.10 requiring HERS inspection to verify that specified DHW pipes are insulated according to the pipe insulation requirements in Title 24, Part 6. The new section would describe the verification coverage within the heating plant and horizontal supply header and return piping and sampling approach for vertical supply risers and branches.

4.1.3.2 Specific Purpose and Necessity of Changes to the Nonresidential and Multifamily ACM Reference Manual

The purpose and necessity of proposed changes to the Nonresidential and Multifamily ACM Reference Manual are described below. See Section 11.4 of this report for the detailed proposed revisions to the text of the ACM Reference Manual.

This proposal would modify the following section of the Nonresidential and Multifamily ACM Reference Manual. See Section 11.4 of this report for the detailed proposed revisions to the text of the ACM Reference Manual.

Residential ACM Appendix B – Water Heating Calculation Method

B5.1 Hourly Recirculation Loop Pipe Heat Loss Calculation: The proposed changes would update default values and text descriptions for Correction Factor, f_{UA} , referenced in Equation 20 to reflect the energy impact without and with pipe insulation verification. Relocation of the text descriptions for $U_{bare,n}$ and $U_{insul,n}$ and Equation 21 improves readability and clarity.

4.1.3.3 Summary of Changes to the Nonresidential and Multifamily Compliance Manual

Chapter 11.6 of the Nonresidential and Multifamily Compliance Manual would need to be revised. Specifically, it would require adding a summary of the measure to the

“What’s New” section under Section 11.6.1.1 for cleanup of pipe insulation mandatory code requirements and pipe insulation verification requirements.

Additions to Section 11.6.5.4 Mandatory requirements for Water Heating – Pipe Insulation would detail the pipe insulation language edits and additions.

4.1.3.4 Summary of Changes to Compliance Forms

The proposed code change would modify the compliance forms listed below. Examples of the revised forms are presented in Section 11.5.

- **2022-LMCC-PLB-E: Domestic Water Heating: Low-Rise Multifamily Certificate of Compliance Domestic Water Heating:** Adds questions on if the design team has met the mandatory requirements for heating plant and distribution pipe insulation.
- **2022-NRCC-PLB-E: Domestic Water Heating: Nonresidential Certificate of Compliance Domestic Water Heating:** Adds questions on if the design team has met the mandatory requirements for heating plant and distribution pipe insulation.
- **2022-LMCI-PLB-E: Domestic Water Heating: Low-Rise Multifamily Certificate of Inspection Domestic Water Heating:** Adds questions on if the construction team has met the mandatory requirements for heating plant and distribution pipe insulation.
- **2022-NRCI-PLB-E: Domestic Water Heating: Nonresidential Certificate of Inspection Domestic Water Heating:** Adds questions on if the construction team has met the mandatory requirements for heating plant and distribution pipe insulation.
- **2022-LMCV-PLB-21-HERS: HERS Verified Multifamily Central Hot Water System Distribution: Low-Rise Multifamily Certificate of Verification Domestic Water Heating:** Adds a mandatory requirement and prompts the HERS Rater to review the heating plant and distribution pipe insulation installation to ensure that it has been installed to the mandatory code requirements.
- **2022-NRCV-PLB-21-HERS: High-Rise Multifamily Central Hot Water System Distribution: Nonresidential Certificate of Verification Domestic Water Heating:** Adds a mandatory requirement and prompts the HERS Rater to review the heating plant and distribution pipe insulation installation to ensure that it has been installed to the mandatory code requirements.

4.1.4 Regulatory Context

4.1.4.1 Determination of Inconsistency or Incompatibility with Existing State Laws and Regulations

The ACM Reference Manual has a compliance credit, PIC-H, for field verification of pipe insulation quality that reduces distribution heat losses by 15 percent according to Table B-1 of the ACM Reference Manual. In the residential appendices, RA3.6.2 contains HERS verification of pipe insulation for hot water distribution systems that is required when taking the PIC-H credit. This credit is only available for trunk and branch distribution systems in single family and low-rise residential buildings. RA3.6.2 requires verification that pipe insulation installation meets the requirements of Title 24, Part 6 Section 150.0(j).

There are similar insulation verification procedures for QII of wall insulation in RA3.5.

Lastly, RA2.6 describes the verification, testing, and sampling protocols for HERS verifications. This section outlines the definition of open groups, closed groups, the protocol for sampling rates, and the procedures for additional testing if a unit or units fail which would be referenced in the requirements for pipe insulation verification.

CPC 2019 Section 609.11 requires insulation on all pipes and piping accessories by implication because only specific exceptions are cited. Exceptions include piping penetrating framing member and piping between the fixture control valve and appliances.

4.1.4.2 Duplication or Conflicts with Federal Laws and Regulations

There are no relevant federal laws or regulations.

4.1.4.3 Difference From Existing Model Codes and Industry Standards

ASHRAE 90.1 is a relevant existing model code, explained in more detail in the Justification and Background Information section of the report.

4.1.5 Compliance and Enforcement

When developing this proposal, the Statewide CASE Team considered methods to streamline the compliance and enforcement process and how negative impacts on market actors who are involved in the process could be mitigated or reduced. This section describes how to comply with the proposed code change. It also describes the compliance verification process. Section 4.2 presents how the proposed changes could impact various market actors.

The compliance verification activities related to this measure that need to occur during each phase of the project are described below:

- **Design Phase:** Designers currently provide or reference Title 24, Part 6 pipe insulation requirements and insulation thickness table, insulation material and pipe support specifications, custom pipe insulation requirements for sections not explicitly covered by code, and supplemental drawings and tables. Designers need to complete the LMCC-PLB-01-E and NRCC-PLB-01-E compliance documents, which now would include an expanded pipe insulation section.
 - Designers would experience a refined process with this proposed code change that would reduce the need for custom pipe insulation requirements, tables, and drawings to be provided on building plans.
 - Designers can reprint or reference the appropriate sections in Title 24, Part 6, and this standardized language would cover a much larger portion of the information that they pass on to the contractor than previously.
- **Permit Application Phase:** Energy consultants make the desired pipe insulation verification selection (Y/N) in the compliance software for the project when using the performance approach, and the information is submitted as part of the permit application package.
- **Construction Phase:** The contractor would follow permitted building plans and assemble and fabricate pipe insulation as specified. The requirements relating to appurtenances and pipe supports and quality installation practices are significant and would require additional procurement, coordination, and installation time and may require staff training. Contractors would populate and sign the LMCI-PLB-01-E or NRCI-PLB-01-E forms marking off the completion of the mandatory pipe insulation requirements.
 - Insulation contractors would need to provide more extensive and uniform pipe insulation. This requirement may add time and complexity to the insulation installation process, which may be offset by consistency and clarity in pipe insulation requirements provided by the designer.
 - The contractor can streamline pipe insulation installation process from site to site with consistent code requirements.
 - Contractors would likely need to provide additional coordination between trades on site to enable visual verification of insulation by a HERS Rater or ATT professional and accompany HERS Rater or ATT personnel during verification visits.
- **Inspection Phase:** HERS Rater would need to coordinate and schedule verification visits with contractors or general contractors to ensure mandatory pipe insulation requirements are followed during construction. HERS Rater would populate the LMCV/NRCV form, and after the verification visits, both the HERS Rater and contractors would provide signatures for the compliance form.

- Multiple verification visits may be needed, as plumbing insulation is often phased with other trades on site, particularly for larger buildings.
- Combined verification efforts where multiple verification activities are performed at the same time is possible. QII is the prime example for potential combined verification visits since there are similarities between construction phasing of wall cavity installation, sampling requirements, and verifications activities between QII and pipe insulation verification.
- Building officials would need to learn about the new pipe insulation requirements.

- **Sample language for Pipe Insulation Verification Form**

A. <u>Domestic Hot Water Recirculation System Pipe Insulation Verification</u>			
05	<p><u>Visual verifications shall cover:</u></p> <ul style="list-style-type: none"> ● <u>All piping and insulation in the mechanical/boiler room where water heating equipment resides, or all outdoor pipes if water heater is outdoors.</u> ● <u>All pipe insulation on horizontal distribution pipes that function as a supply header, up the point of connection with riser pipes. Supply header is piping between the water heater and vertical risers that run up or down the building.</u> ● <u>A sample of pipe insulation on vertical pipe risers: the sample rate shall be one in two risers. Riser inspection shall include the entire vertical length of DHW recirculation riser pipe, including offsets and horizontal portions of recirculation loop, up to the point of connection of the branch pipe (non-recirculating) to dwelling units.</u> <p><u>If field verification of pipe insulation in any of the three portions results in a failure, the HERS Rater or ATT shall enter the failure into the HERS or ATT data registry. Contractors shall take corrective action, and the HERS Rater or ATT shall re-check the corrective action.</u></p> <p><u>If field verification of sampled vertical pipe risers results in a failure, the building then becomes subject to verification of 100 percent of remaining pipe risers that are still visually accessible. The building passes if the HERS Rater or ATT verifies that the corrective action was successful during re-check, and if all risers remaining visually accessible meet the verification requirements.</u></p>		
06	<table border="1" style="width: 100%; border-collapse: collapse;"> <tr> <td style="width: 30%;"><u>Verification Status–</u></td> <td> <input type="checkbox"/> <u>Pass - all applicable requirements are met;–or</u> <input type="checkbox"/> <u>Fail - one or more applicable requirements are not met.</u> <u>Enter reason for failure in corrections notes field below; or–</u> <input type="checkbox"/> <u>All N/A - This entire table is not applicable</u> </td> </tr> </table>	<u>Verification Status–</u>	<input type="checkbox"/> <u>Pass - all applicable requirements are met;–or</u> <input type="checkbox"/> <u>Fail - one or more applicable requirements are not met.</u> <u>Enter reason for failure in corrections notes field below; or–</u> <input type="checkbox"/> <u>All N/A - This entire table is not applicable</u>
<u>Verification Status–</u>	<input type="checkbox"/> <u>Pass - all applicable requirements are met;–or</u> <input type="checkbox"/> <u>Fail - one or more applicable requirements are not met.</u> <u>Enter reason for failure in corrections notes field below; or–</u> <input type="checkbox"/> <u>All N/A - This entire table is not applicable</u>		

	<u>Correction Notes:</u>	
01	<u>Recirculation pipe insulation must meet the applicable requirements specified in § 160.4.</u>	
02	<u>All pipes, fittings, and appurtenances shall be insulated, including all elbows, tees, valves, pumps, and other piping devices at the heating plant and distribution system piping</u>	
03	<u>Metal pipe hangers supporting metal pipe shall have noncompressible thermal isolation between the hanger and pipe.</u>	
04	<u>Piping insulation seams sealed, elbows mitered, tees notched</u>	
05	<u>Visual verifications shall cover:</u> <ul style="list-style-type: none"> • <u>All piping and insulation in the mechanical/boiler room where water heating equipment resides, or all outdoor pipes if water heater is outdoors.</u> • <u>All pipe insulation on horizontal distribution pipes that function as a supply header, up the point of connection with riser pipes. Supply header is piping between the water heater and vertical risers that run up or down the building.</u> • <u>A sample of pipe insulation on vertical pipe risers: the sample rate shall be one in two risers. Riser inspection shall include the entire vertical length of DHW recirculation riser pipe, including offsets and horizontal portions of recirculation loop, up to the point of connection of the branch pipe (non-recirculating) to dwelling units.</u> <p><u>If field verification of pipe insulation in any of the three portions results in a failure, the HERS Rater or ATT shall enter the failure into the HERS or ATT data registry. Contractors shall take corrective action, and the HERS Rater or ATT shall re-check the corrective action.</u></p> <p><u>If field verification of sampled vertical pipe risers results in a failure, the building then becomes subject to verification of 100 percent of remaining pipe risers that are still visually accessible. The building passes if the HERS Rater or ATT verifies that the corrective action was successful during re-check, and if all risers remaining visually accessible meet the verification requirements.</u></p>	
06	<u>Verification Status–</u>	<input type="checkbox"/> <u>Pass - all applicable requirements are met;–or</u> <input type="checkbox"/> <u>Fail - one or more applicable requirements are not met.</u> <u>Enter reason for failure in corrections notes field below; or–</u> <input type="checkbox"/> <u>All N/A - This entire table is not applicable</u>
	<u>Correction Notes:</u>	
<u>The responsible person’s signature on this compliance document affirms that all applicable requirements in this table have been met.</u>		

4.2 Market Analysis

4.2.1 Current Market Structure

The 2025 Statewide CASE Team performed a market analysis by reviewing 40 building plans and conducting literature review with the goals of identifying current product availability, and market trends. The market analysis found that pipe insulation, insulation fabrication, and pipe support products are widely available for designers to specify and for contractors to procure, and many options are available for contractors to meet the pipe insulation code requirements through purchasing prefabricated products or fabricating materials onsite. The proposed code change would have a small impact on the market in general based on plan reviews, as designers were specifying piping insulation to varying degrees above code requirements for most buildings.

DHW pipe insulation is typically installed by the plumbing subcontractor or an independent insulation subcontractor. Plumbing subcontractors usually provide both plumbing and insulation on smaller buildings, while larger buildings often have separate contractors for plumbing and insulation installation.

Based on interviews with designers and contractors, the 2025 Statewide CASE Team found widespread confusion on the current pipe insulation requirements based on several factors. One general contractor interviewed works with the building inspector to ensure they meet the inspector's interpretation of the building requirements. Market actors such as pipe insulation subcontractors are already uniformly insulating piping for some clients, and they welcome the consistency that this measure would bring to their industry.

Pipe insulation currently covers all supply and return pipes and fittings in Title 24, Part 6, Section 160.4. The existing code lacks language for some specific sections of the piping system. As an example, there is no specific language mentioning the requirement for adding uniform pipe insulation to cover the heating plant, appurtenances, pipe supports, and branch piping leading from the loop. This measure would require increased attention to detail by pipe insulation contractors to ensure that insulation is complete and well installed.

The proposed code measure adds third-party field verification such as HERS Rater or ATT personnel to verify that the installation of pipe insulation meets code requirements.

In addition to conducting personalized outreach, the Statewide CASE Team discussed the current market structure and potential market barriers during a public stakeholder meeting that the Statewide CASE Team held on February 17, 2023.

4.2.2 Technical Feasibility and Market Availability

4.2.2.1 Technical Feasibility

Current pipe insulation design specifications and drawings are available and comprehensive on a few plans and limited on many building plans reviewed. This general lack of pipe insulation specification is likely a result of unclear pipe insulation code language in current and prior versions of the energy code. Part of the solution is the explicit code language proposed, which the designer can supplement with detailed drawings and instructions. Training could be provided to the design community on new code requirements and best practice plumbing design materials to ensure comprehensive information is passed on to the contractor.

The Statewide CASE Team interviewed pipe insulation subcontractors and found that they have the necessary skills and experience to install uniform pipe insulation on DHW systems based on their experience with high-temperature fluid systems, such as steam systems and meeting OSHA requirements, to minimize exposed pipe or appurtenances to prevent scalding. If the proposed measure is approved, a problem may arise where the specialized subcontractor labor force may need to expand to meet market demand. Contractor training is needed to ensure their understanding of proper insulation installation. Additionally, pipe insulation procurement and installation training should be provided to general contractors and their staff to ensure they are aware of the proposed code requirements.

In general practice, insulating piping for DHW systems is not prioritized to allow for proper materials procurement of and to develop a plan for seamless installation. Shortcuts are taken to reduce the overall cost associated with planning, procurement, labor, and materials.

The Statewide CASE Team believes that the addition of explicit mandatory pipe insulation language that requires continuous pipe insulation would make it easier to complete field verification of pipe insulation installation, since the insulation requirements are clear and consistent, and all the heating plant and hot water distribution piping would be insulated with no gaps for easy visual inspection. Current construction phasing practices may be a barrier to pipe insulation verification, where drywall is often installed soon after pipe insulation is installed. This proposed pipe verification component requires a window of time where pipe insulation is exposed before drywall installation. If phasing is an issue, general contractors would need to coordinate subcontractor schedules to allow for pipe insulation verification. For the 2022 Title 24, Part 6 code update cycle where insulation verification was first proposed, the 2022 Statewide CASE Team conducted interviews with designers and a HERS Rater to discuss this issue and concluded that close coordination between the general contractor/construction supervisor and HERS Rater is necessary to time the visits and

limit the impact on the construction schedule, while maintaining an adequate sampling rate. Interviewees thought that coordination was achievable if a sampling method was used (one in seven DHW recirculation pipe risers for example) and would be an issue if complete (100 percent) inspection was required.

4.2.2.2 Market Availability

Current Market by Insulation Type

The Statewide CASE Team reviewed 43 multifamily building plans in California. 30 of the 43 (70 percent) buildings have insulation information.

18 of the buildings have individual water heating distribution systems. Among them:

- 8 have no insulation material information (44 percent)
- 6 have foam insulation (33 percent), and
- 4 have fiberglass insulation (22 percent)

25 of the buildings have central water heating distribution systems. Among them:

- 5 have no insulation material information (20 percent)
- 6 have foam insulation (24 percent), and
- 14 have fiberglass insulation (56 percent)

The fiberglass insulation market better serves the market need to provide uniform pipe insulation for hot water piping with a wider range of products such as PVC elbow, tee covers, and pipe jacketing that support contractors especially for custom fabrication tasks, which are commonly required for insulating appurtenances.

Detailed Designer Pipe Insulation Requirements

The Statewide CASE Team reviewed pipe insulation language in detail on 23 new construction and 9 retrofit project drawings. Of these, 16 of the 23 new construction sites did not provide additional pipe insulation language beyond minimum code requirements, and 7 projects provided additional pipe insulation information, as follows:

- 6 have pipe jacketing language (26 percent)
- 3 have pipe support insulation language (13 percent)
- 4 have language for sealed seams (17 percent)
- 5 have language for PVC fitting covers (22 percent)
- 2 have specific language on appurtenances (9 percent)
- 7 have language for heating plant pipe insulation (30 percent)

The Statewide CASE Team reviewed seven building plans that referenced the 2016 or 2019 Title 24, Part 6 Section 150.0 pipe insulation code language or associated language in Section 5.3.5 in the Residential Compliance Manual with heating plant pipe insulation language. If the 7 building plans with heating plant requirements referencing

old residential low rise code sections are filtered out from the 23 projects reviewed, only 1 out of 16 high-rise buildings, or six percent, has comprehensive language for heating plant insulation in their plan drawings.

Overall, The Statewide Team building plans analysis shows designers and developers are not voluntarily incorporating continuous pipe insulation requirements into their building plans indicating the need for mandatory language in code.

4.2.3 Market Impacts and Economic Assessments

4.2.3.1 Impact on Builders

Builders of residential and commercial structures are directly impacted by many of the measures proposed by the Statewide CASE Team for the 2025 code cycle. It is within the normal practices of these businesses to adjust their building practices to changes in building codes. When necessary, builders engage in continuing education and training to remain compliant with changes to design practices and building codes.

California’s construction industry comprises approximately 93,000 business establishments and 943,000 employees (see Table 55). For 2022, total estimated payroll would be about \$78 billion. Nearly 72,000 of these business establishments and 473,000 employees are engaged in the residential building sector, while another 17,600 establishments and 369,000 employees focus on the commercial sector. The remainder of establishments and employees work in industrial, utilities, infrastructure, and other heavy construction roles (the industrial sector).

Table 55: California Construction Industry, Establishments, Employment, and Payroll in 2022 (Estimated)

Building Type	Construction Sectors	Establishments	Employment	Annual Payroll (Billions \$)
Residential	All	71,889	472,974	31.2
Residential	Building Construction Contractors	27,948	130,580	9.8
Residential	Foundation, Structure, & Building Exterior	7,891	83,575	5.0
Residential	Building Equipment Contractors	18,108	125,559	8.5
Residential	Building Finishing Contractors	17,942	133,260	8.0
Commercial	All	17,621	368,810	35.0
Commercial	Building Construction Contractors	4,919	83,028	9.0
Commercial	Foundation, Structure, & Building Exterior	2,194	59,110	5.0
Commercial	Building Equipment Contractors	6,039	139,442	13.5
Commercial	Building Finishing Contractors	4,469	87,230	7.4

Building Type	Construction Sectors	Establishments	Employment	Annual Payroll (Billions \$)
Industrial, Utilities, Infrastructure, & Other (Industrial+)	All	4,206	101,002	11.4
Industrial+	Building Construction	288	3,995	0.4
Industrial+	Utility System Construction	1,761	50,126	5.5
Industrial+	Land Subdivision	907	6,550	1.0
Industrial+	Highway, Street, and Bridge Construction	799	28,726	3.1
Industrial+	Other Heavy Construction	451	11,605	1.4

Source: (State of California n.d.)

The proposed change to pipe insulation verification and insulation enhancement would likely affect multifamily residential builders but would not impact firms that focus on construction and retrofit of industrial buildings, utility systems, public infrastructure, or other heavy construction. The effects on the residential and commercial building industry would not be felt by all firms and workers, but rather would be concentrated in specific industry subsectors. Table 56 shows the residential building subsectors the Statewide CASE Team expects to be impacted by the changes proposed in this report. With the additional insulation The Statewide CASE Team’s estimates of the magnitude of these impacts are shown in Section 4.2.4 Economic Impacts.

Table 56: Specific Subsectors of the California Residential Building Industry by Subsector in 2022 (Estimated)

Residential Building Subsector	Establishments	Employment	Annual Payroll (Billions \$)
New multifamily general contractors	421	6,344	0.7
Residential plumbing and HVAC contractors	9,852	75,404	5.1

Source: (State of California n.d.)

4.2.3.2 Impact on Building Designers and Energy Consultants

Adjusting design practices to comply with changing building codes is within the normal practices of building designers. Building codes (including Title 24, Part 6) are typically updated on a three-year revision cycle and building designers and energy consultants engage in continuing education and training to remain compliant with changes to design practices and building codes.

Currently, designers seem to give pipe insulation minimal consideration on design documents, aside from a minimum thickness table. This measure would require the designer to be explicit about what gets insulated as a result of this enhanced insulation

measure in the DHW piping system in their specifications, notes, or details on the plans. The instructions must be so specific as to eliminate any doubt in an insulation contractor’s mind about what needs to be insulated or where they may be able to take liberties in their installation.

Businesses that focus on residential, commercial, institutional, and industrial building design are contained within the Architectural Services sector (NAICS 541310). shows the number of establishments, employment, and total annual payroll for Building Architectural Services. The proposed code changes would potentially impact all firms within the Architectural Services sector. While this is a multifamily measure, The Statewide CASE Team anticipates the impacts for pipe insulation verification and insulation enhancement to affect firms that focus multifamily and nonresidential construction.

There is not a NAICS²⁵ code specific to energy consultants. Instead, businesses that focus on consulting related to building energy efficiency are contained in the Building Inspection Services sector (NAICS 541350), which is comprised of firms primarily engaged in the physical inspection of residential and nonresidential buildings.²⁶ It is not possible to determine which business establishments within the Building Inspection Services sector are focused on energy efficiency consulting. The information shown in Table 57 provides an upper bound indication of the size of this sector in California.

Table 57: California Building Designer and Energy Consultant Sectors in 2022 (Estimated)

Sector	Establishments	Employment	Annual Payroll (Millions \$)
Architectural Services²⁷	4,134	31,478	3,623.3
Building Inspection Services²⁸	1,035	3,567	280.7

Source: (State of California n.d.)

²⁵ NAICS is the standard used by federal statistical agencies in classifying business establishments for the purpose of collecting, analyzing, and publishing statistical data related to the U.S. business economy. NAICS was developed jointly by the U.S. Economic Classification Policy Committee (ECPC), Statistics Canada, and Mexico's Instituto Nacional de Estadística y Geografía, to allow for a high level of comparability in business statistics among the North American countries. NAICS replaced the Standard Industrial Classification (SIC) system in 1997.

²⁶ Establishments in this sector include businesses primarily engaged in evaluating a building’s structure and component systems and includes energy efficiency inspection services and home inspection services. This sector does not include establishments primarily engaged in providing inspections for pests, hazardous wastes or other environmental contaminants, nor does it include state and local government entities that focus on building or energy code compliance/enforcement of building codes and regulations.

²⁷ Architectural Services (NAICS 541310) comprises private-sector establishments primarily engaged in planning and designing residential, institutional, leisure, commercial, and industrial buildings and structures.

²⁸ Building Inspection Services (NAICS 541350) comprises private-sector establishments primarily engaged in providing building (residential & nonresidential) inspection services encompassing all aspects of the building structure and component systems, including energy efficiency inspection services.

4.2.3.3 Impact on Occupational Safety and Health

The proposed code change does not alter any existing federal, state, or local regulations pertaining to safety and health, including rules enforced by the California DOSH. All existing health and safety rules would remain in place. Complying with the proposed code change is not anticipated to have adverse impacts on the safety or health of occupants or those involved with the construction, commissioning, and maintenance of the building. However, adding insulation to appurtenances in a DHW piping system would reduce the risk of scalds and burns from exposed pipe.

4.2.3.4 Impact on Building Owners and Occupants Including Homeowners and Potential First-Time Homeowners

Residential Buildings

According to data from the U.S. Census ACS, there were more than 14.5 million housing units in California in 2021 and nearly 13.3 million were occupied (see Table 58). Most housing units (nearly 9.42 million) were single family homes (either detached or attached), approximately 2 million homes were in buildings containing 2 to 9 units, and 2.5 million homes were in multifamily buildings containing 10 or more units. The California Department of Revenue estimated that building permits for 67,300 single family and 54,900 multifamily homes would be issued in 2022, up from 66,000 single family and 53,500 multifamily permits issued in 2021.

Table 58: California Housing Characteristics in 2021²⁹

Housing Measure	Estimate
Total housing units	14,512,281
Occupied housing units	13,291,541
Vacant housing units	1,220,740
Homeowner vacancy rate	0.7%
Rental vacancy rate	4.3%
Number of 1-unit, detached structures	8,388,099
Number of 1-unit, attached structures	1,030,372
Number of 2-unit structures	348,295
Number of 3- or 4-unit structures	783,663
Number of 5- to 9-unit structures	856,225
Number of 10- to 19-unit structures	740,126
Number of 20+ unit structures	1,828,547
Mobile home, RV, etc.	522,442

Sources: (United States Census Bureau n.d.), (Federal Reserve Economic Data (FRED) n.d.)

²⁹ Total housing units as reported for 2021; all other housing measures estimated based on historical relationships.

Table 59 shows the distribution of California homes by vintage. About 15 percent of California homes were built in 2000 or later and another 11 percent built between 1990 and 1999. The majority of California’s existing housing stock (8.5 million homes – 59 percent of the total) were built between 1950 and 1989, a period of rapid population and economic growth in California. Finally, about 2.1 million homes in California were built before 1950. According to Kenney et al, 2019, more than half of California’s existing multifamily buildings (those with five or more units) were constructed before 1978 when there were no building energy efficiency standards (Kenney 2019).

Table 59: Distribution of California Housing by Vintage in 2021 (Estimated)

Home Vintage	Units	Percent	Cumulative Percent
Built 2014 or later	348,296	2.4	2.4
Built 2010 to 2013	261,221	1.8	4.2
Built 2000 to 2009	1,581,839	10.9	15.1
Built 1990 to 1999	1,596,351	11.0	26.1
Built 1980 to 1989	2,191,354	15.1	41.2
Built 1970 to 1979	2,539,649	17.5	58.7
Built 1960 to 1969	1,915,621	13.2	71.9
Built 1950 to 1959	1,930,133	13.3	85.2
Built 1940 to 1949	841,712	5.8	91.0
Built 1939 or earlier	1,306,105	9.0	100.0
Total housing units	14,512,281	100.0	–

Sources: (United States Census Bureau n.d.), (Federal Reserve Economic Data (FRED) n.d.)

Table 60 shows the distribution of owner- and renter-occupied housing by household income. Overall, about 55 percent of California housing is owner-occupied and the rate of owner-occupancy generally increases with household income. The owner-occupancy rate for households with an income below \$50,000 is only 37 percent, whereas the owner occupancy rate is 71 percent for households earning \$100,000 or more.

Table 60: Owner- and Renter-Occupied Housing Units in California by Income in 2021 (Estimated)

Household Income	Total	Owner Occupied	Renter Occupied
Less than \$5,000	353,493	113,315	240,178
\$5,000 to \$9,999	254,304	74,939	179,366
\$10,000 to \$14,999	495,287	134,633	360,654
\$15,000 to \$19,999	412,498	144,064	268,435
\$20,000 to \$24,999	467,694	169,431	298,264
\$25,000 to \$34,999	906,996	355,968	551,028

Household Income	Total	Owner Occupied	Renter Occupied
\$35,000 to \$49,999	1,319,892	560,453	759,438
\$50,000 to \$74,999	2,036,560	990,769	1,045,791
\$75,000 to \$99,999	1,662,032	920,607	741,425
\$100,000 to \$149,999	2,307,889	1,490,247	817,642
\$150,000 or more	3,074,895	2,337,651	737,244
Total Housing Units	13,291,541	7,292,076	5,999,465

Source: (United States Census Bureau n.d.), (Federal Reserve Economic Data (FRED) n.d.)

Understanding the distribution of California residents by home type, home vintage, and household income is critical for developing meaningful estimates of the economic impacts associated with proposed code changes affecting residents. Many proposed code changes specifically target single family or multifamily residences and so the counts of housing units by building type shown in Table 58. Table 60 provides the information necessary to quantify the magnitude of potential impacts. Likewise, impacts may differ for owners and renters, by home vintage, and by household income, information provided in Table 59 and Table 60.

Estimating Impacts

For California residents, the proposed code changes would result in lower energy bills. The Statewide CASE Team estimates that on average the proposed change to Title 24, Part 6 would increase construction cost by about \$32 per multifamily dwelling unit, but the measure would also result in an average savings of \$1,999 in energy and maintenance cost savings over 30 years. This is roughly equivalent to a \$0.19 per month increase in payments for a 30-year mortgage and a \$5.55 per month reduction in energy costs. Overall, the Statewide CASE Team expects the 2025 Title 24, Part 6 Standards to save homeowners about \$64 per year relative to homeowners whose dwelling units are minimally compliant with the 2022 Title 24, Part 6 requirements. As discussed in section 4.2.4.1 when homeowners or building occupants save on energy bills, they tend to spend it elsewhere thereby creating jobs and economic growth for the California economy. Energy cost savings can be particularly beneficial to low-income homeowners who typically spend a higher portion of their income on energy bills, often have trouble paying energy bills, and sometimes go without other necessities to save money for energy bills (Association, National Energy Assistance Directors 2011).

4.2.3.5 Impact on Building Component Retailers (Including Manufacturers and Distributors)

Because of the enhanced insulation measure additional insulation would be required to insulate appurtenances and any piping not currently clearly called out in the code. The

Statewide CASE Team does expect insulation manufacturers and distributors to see an increase in product sales and revenue.

4.2.3.6 Impact on Building Inspectors

The Statewide CASE Team does not expect building inspectors to be impacted by the insulation verification measure. Table 61 shows employment and payroll information for state and local government agencies in which many inspectors of residential and commercial buildings are employed. Building inspectors participate in continuing education and training to stay current on all aspects of building regulations, including energy efficiency. Therefore, the Statewide CASE Team anticipates the proposed change would have no impact on employment of building inspectors or the scope of their role conducting energy efficiency inspections.

Table 61: Employment in California State and Government Agencies with Building Inspectors in 2022 (Estimated)

Sector	Govt.	Establishments	Employment	Annual Payroll (Million \$)
Administration of Housing Programs³⁰	State	18	265	29.0
	Local	38	3,060	248.6
Urban and Rural Development Admin³¹	State	38	764	71.3
	Local	52	2,481	211.5

Source: (State of California, Employment Development Department n.d.)

4.2.3.7 Impact on Statewide Employment

As described in Sections 4.2.3.1 through 4.2.3.6, the Statewide CASE Team does not anticipate significant employment or financial impacts to any sector of the California economy. This is not to say that the proposed change would not have modest impacts on employment in California. In Section 4.2.4, the Statewide CASE Team estimated the proposed change in insulation enhancement and verification would affect statewide employment and economic output directly and indirectly through its impact on builders, designers and energy consultants, and building inspectors. In addition, the Statewide CASE Team estimated how energy savings associated with the proposed change in insulation enhancement and verification would lead to modest ongoing financial savings for California residents, which would then be available for other economic activities.

³⁰ Administration of Housing Programs (NAICS 925110) comprises government establishments primarily engaged in the administration and planning of housing programs, including building codes and standards, housing authorities, and housing programs, planning, and development.

³¹ Urban and Rural Development Administration (NAICS 925120) comprises government establishments primarily engaged in the administration and planning of the development of urban and rural areas. Included in this industry are government zoning boards and commissions.

4.2.4 Economic Impacts

For the 2025 code cycle, the Statewide CASE Team used the IMPLAN model software,³² along with economic information from published sources, and professional judgement to develop estimates of the economic impacts associated with each of the proposed code changes. Conceptually, IMPLAN estimates jobs created as a function of incoming cash flow in different sectors of the economy, due to implementing a code or a standard. The jobs created are typically categorized into direct, indirect, and induced employment. For example, cash flow into a manufacturing plant captures direct employment (jobs created in the manufacturing plant), indirect employment (jobs created in the sectors that provide raw materials to the manufacturing plant) and induced employment (jobs created in the larger economy due to purchasing habits of people newly employed in the manufacturing plant). Eventually, IMPLAN computes the total number of jobs created due to a code. The assumptions of IMPLAN include constant returns to scale, fixed input structure, industry homogeneity, no supply constraints, fixed technology, and constant byproduct coefficients. The model is also static in nature and is a simplification of how jobs are created in the macro-economy.

The economic impacts developed for this report are only estimates and are based on limited and to some extent speculative information. The IMPLAN model provides a relatively simple representation of the California economy and, though the Statewide CASE Team is confident that the direction and approximate magnitude of the estimated economic impacts are reasonable, it is important to understand that the IMPLAN model is a simplification of extremely complex actions and interactions of individual, businesses, and other organizations as they respond to changes in energy efficiency codes. In all aspects of this economic analysis, the CASE Authors rely on conservative assumptions regarding the likely economic benefits associated with the proposed code change. By following this approach, the economic impacts presented below represent lower bound estimates of the actual benefits associated with this proposed code change.

Adoption of this code change proposal would result in relatively modest economic impacts through the additional direct spending by those in the residential building and remodeling industry as well as indirectly as residents spend all or some of the money saved through lower utility bills on other economic activities.³³ There may also be some nonresidential customers that are impacted by this proposed code change; however,

³² IMPLAN employs economic data and advanced economic impact modeling to estimate economic impacts for interventions like changes to the California Title 24, Part 6 code. For more information on the IMPLAN modeling process, see www.IMPLAN.com.

³³ For example, for the lowest income group, the Statewide CASE Team assumes 100 percent of money saved through lower energy bills would be spent, while for the highest income group, the Statewide CASE Team assumes only 64 percent of additional income would be spent.

the Statewide CASE Team does not anticipate such impacts to be materially important to the building owner and would have measurable economic impacts.

The Statewide CASE Team anticipates no direct effect on designers or energy consultants, so the values in Table 63 are zeroed out to indicate this condition.

Table 62: Estimated Impact that Adoption of the Proposed Measure would have on the California Residential Construction

Type of Economic Impact	Employment (Jobs)	Labor Income	Total Value Added	Output
Direct Effects (Additional spending by Residential Builders)	13.8	\$1,091,715	\$1,790,763	\$2,183,900
Indirect Effect (Additional spending by firms supporting Residential)	2.1	\$154,469	\$251,588	\$433,874
Induced Effect (Spending by employees of firms experiencing “direct” or “indirect” effects)	5.1	\$349,540	\$625,797	\$996,031
Total Economic Impacts	21.0	\$1,595,723	\$2,668,148	\$3,613,805

Source: Statewide CASE Team analysis of data from the IMPLAN modeling software.³⁴

Table 63: Estimated Impact that Adoption of the Proposed Measure would have on the California Building Designers and Energy Consultants

Type of Economic Impact	Employment (Jobs)	Labor Income	Total Value Added	Output
Direct Effects (Additional spending by Building Designers & Energy Consultants)	0.3	\$31,610	\$31,293	\$49,462
Indirect Effect (Additional spending by firms supporting Bldg. Designers & Energy Consultants)	0.1	\$9,412	\$13,081	\$21,057
Induced Effect (Spending by employees of firms experiencing “direct” or “indirect” effects)	0.2	\$11,796	\$21,123	\$33,621
Total Economic Impacts	0.6	\$52,817	\$65,497	\$104,140

Source: Statewide CASE Team analysis of data from the IMPLAN modeling software.

³⁴ IMPLAN® model, 2020 Data, IMPLAN Group LLC, IMPLAN System (data and software), 16905 Northcross Dr., Suite 120, Huntersville, NC 28078 www.IMPLAN.com

Table 64: Estimated Impact that Adoption of the Proposed Measure would have on California Building Inspectors

Type of Economic Impact	Employment (Jobs)	Labor Income	Total Value Added	Output
Direct Effects (Additional spending by Building Inspectors)	0.7	\$79,736	\$94,557	\$114,905
Indirect Effect (Additional spending by firms supporting Building Inspectors)	0.1	\$7,385	\$11,501	\$20,031
Induced Effect (Spending by employees of Building Inspection Bureaus and Departments)	0.4	\$25,079	\$44,925	\$71,506
Total Economic Impacts	1.2	\$112,200	\$150,983	\$206,443

Source: Statewide CASE Team analysis of data from the IMPLAN modeling software.

4.2.4.1 Creation or Elimination of Jobs

The Statewide CASE Team does not anticipate that the measures proposed for the 2025 code cycle regulation would lead to the creation of new *types* of jobs or the elimination of *existing* types of jobs. In other words, the Statewide CASE Team’s proposed change would not result in economic disruption to any sector of the California economy. Rather, the estimates of economic impacts discussed in Section 4.2.4 would lead to modest changes in employment of existing jobs.

4.2.4.2 Creation or Elimination of Businesses in California

As stated in Section 4.2.4, the Statewide CASE Team’s proposed change would not result in economic disruption to any sector of the California economy. The proposed change represents a modest change to pipe insulation and verification, which would not excessively burden or competitively disadvantage California businesses—nor would it necessarily lead to a competitive advantage for California businesses. Therefore, the Statewide CASE Team does not foresee any new businesses being created, nor does the Statewide CASE Team think any existing businesses would be eliminated due to the proposed code changes.

4.2.4.3 Competitive Advantages or Disadvantages for Businesses in California

The proposed code changes would apply to all businesses incorporated in California, regardless of whether the business is located inside or outside of the state.³⁵ Therefore, the Statewide CASE Team does not anticipate that these measures proposed for the 2025 code cycle regulation would have an adverse effect on the competitiveness of

³⁵ Gov. Code, §§ 11346.3(c)(1)(C), 11346.3(a)(2); 1 CCR § 2003(a)(3) Competitive advantages or disadvantages for California businesses currently doing business in the state.

California businesses. Likewise, the Statewide CASE Team does not anticipate businesses located outside of California would be advantaged or disadvantaged.

4.2.4.4 Increase or Decrease of Investments in the State of California

The Statewide CASE Team analyzed national data on corporate profits and capital investment by businesses that expand a firm’s capital stock (referred to as net private domestic investment, or NPDI).³⁶ As Table 65 shows, between 2017 and 2021, NPDI as a percentage of corporate profits ranged from a low of 18 in 2020 due to the worldwide economic slowdowns associated with the COVID-19 pandemic to a high of 35 percent in 2019, with an average of 26 percent. While only an approximation of the proportion of business income used for net capital investment, the Statewide CASE Team believes it provides a reasonable estimate of the proportion of proprietor income that would be reinvested by business owners into expanding their capital stock.

Table 65: Net Domestic Private Investment and Corporate Profits, U.S.

Year	Net Domestic Private Investment by Businesses, Billions of Dollars	Corporate Profits After Taxes, Billions of Dollars	Ratio of Net Private Investment to Corporate Profits (Percent)
2017	518.473	1882.460	28
2018	636.846	1977.478	32
2019	690.865	1952.432	35
2020	343.620	1908.433	18
2021	506.331	2619.977	19
5-Year Average	-	-	26

Source: (Federal Reserve Economic Data (FRED) n.d.)

The Statewide CASE Team does not anticipate that the economic impacts associated with the proposed measure would lead to significant change (increase or decrease) in investment, directly or indirectly, in any affected sectors of California’s economy. Nevertheless, the Statewide CASE Team can derive a reasonable estimate of the change in investment by California businesses based on the estimated change in economic activity associated with the proposed measure and its expected effect on proprietor income, which the Statewide CASE Team uses a conservative estimate of corporate profits, a portion of which the Statewide CASE Team assumes would be allocated to net business investment.³⁷

³⁶ Net private domestic investment is the total amount of investment in capital by the business sector that is used to expand the capital stock, rather than maintain or replace due to depreciation. Corporate profit is the money left after a corporation pays its expenses.

³⁷ 26 percent of proprietor income was assumed to be allocated to net business investment; see Table 65.

4.2.4.5 Incentives for Innovation in Products, Materials, or Processes

The additional insulation to appurtenances in DHW systems required by this measure could well lead to advancements in insulation materials as well as insulation products such as removable insulation blankets for appurtenances that need regular service or access in the event of a replacement.

4.2.4.6 Effects on the State General Fund, State Special Funds, and Local Governments

The Statewide CASE Team does not expect the proposed code changes would have a measurable impact on California's General Fund, any state special funds, or local government funds.

Cost of Enforcement

Cost to the State: State government already has a budget for code development, education, and compliance enforcement. While state government would allocate resources to update the Title 24, Part 6 Standards, including updating education and compliance materials and responding to questions about the revised requirements, these activities are already covered by existing state budgets. The costs to state government are small when compared to the overall costs savings and policy benefits associated with the code change proposals.

Cost to Local Governments: All proposed code changes to Title 24, Part 6 would result in changes to compliance determinations. Local governments would need to train building department staff on the revised Title 24, Part 6 Standards. While this re-training is an expense to local governments, it is not a new cost associated with the 2025 code change cycle. The building code is updated on a triennial basis, and local governments plan and budget for retraining every time the code is updated. There are numerous resources available to local governments to support compliance training that can help mitigate the cost of retraining, including tools, training and resources provided by the IOU Codes and Standards program (such as Energy Code Ace). As noted in Section 4.1.5 and Appendix E, the Statewide CASE Team considered how the proposed code change might impact various market actors involved in the compliance and enforcement process and aimed to minimize negative impacts on local governments.

4.2.4.7 Impacts on Specific Persons

While the objective of any of the Statewide CASE Team's proposal is to promote energy efficiency, the Statewide CASE Team recognizes that there is the potential that a proposed code change may result in unintended consequences. Refer to Section 4.6 for more details addressing energy equity and environmental justice.

4.2.5 Fiscal Impacts

4.2.5.1 Mandates on Local Agencies or School Districts

There are no relevant mandates to school districts, because this only impacts multifamily buildings. There are also no mandates for local agencies because the requirements would be specified at the statewide level through Title 24, Part 6.

4.2.5.2 Costs to Local Agencies or School Districts

There are no costs to school districts, because this only impacts multifamily buildings. For local agencies, there would be increases in work for building inspectors because they would enforce the measure. Section 4.2.3.6 describes the impact on building inspectors.

4.2.5.3 Costs or Savings to Any State Agency

There are no costs or savings to state agencies because they would not be involved in enforcement of the measure.

4.2.5.4 Other Non-Discretionary Cost or Savings Imposed on Local Agencies

There are no added non-discretionary costs or savings to local agencies.

4.2.5.5 Costs or Savings in Federal Funding to the State

There are no costs or savings to federal funding to the state due to the measure. The proposed measure is a relatively small cost which the market would bear. The state would not require federal funding to implement the proposed measure.

4.3 Energy Savings

4.3.1 Energy Savings Methodology

The Statewide CASE Team used a recirculation heat loss spreadsheet calculator (see Appendix H for details) to assess the energy impact of the proposed code change. This spreadsheet calculator used pipe heat loss calculation methods defined in the existing 2022 ACM Reference Manual. The spreadsheet calculator includes features to handle detailed recirculation piping designs, insulation conditions, and recirculation flow controls. In comparison, CBECC uses a simple recirculation model with six pipe sections to streamline code compliance, but it is not capable of assessing energy impact of complicated recirculation system designs found in real buildings. This calculator was also used to support energy impact analysis during the 2022 California Code Cycle for multifamily DHW distribution measures. Based on the output of the

recirculation heat loss calculator, the Statewide CASE Team calculated site, source, and LSC Savings as described in following sections.

4.3.1.1 Key Assumptions for Energy Savings Analysis

The CEC directed the Statewide CASE Team to assess the energy impacts of proposed code change for four prototypical multifamily buildings, as shown in Table 26. Detailed recirculation system piping configurations for these four prototypical buildings were developed during the 2022 Code Cycle (see Appendix I) and were incorporated into the recirculation heat loss spreadsheet calculator to assess distribution heat loss. For each prototypical building, the Statewide CASE Team developed two types of water heating plant: one based on HPWHs and the other based on gas boilers. The Statewide CASE Team used the corresponding piping and appurtenance configurations to evaluate plant pipe heat loss.

For distributions systems, the Statewide CASE Team assumed that the proposed insulation enhancement requirements would have the same effect as reducing uninsulated pipes by 15 percent of the total recirculation pipe surface area. For heating plants, the Statewide CASE Team assumed that the proposed insulation enhancement requirements would reduce uninsulated pipes to 15 percent of straight pipes and 30 percent of appurtenance surface areas. Table 66 provides key assumptions for energy impact analysis for the proposed code change. Please see Appendix H for more details on the percentage of pipes not insulated.

Table 66: Key Assumptions for Assessing Energy Impact of Insulation Enhancement for New Construction

Key Assumption	Base Case	Proposed Case
% of pipes not insulated (Distribution system)	LowRiseGarden: 52% LoadedCorridor: 43% MidRiseMixedUse: 38.5% HighRiseMixedUse: 43%	LowRiseGarden: 37% LoadedCorridor: 28% MidRiseMixedUse: 23.5% HighRiseMixedUse: 28%
% of pipes not insulated (Water heating plant)	Straight pipes: 30% Appurtenances: 100%	Straight pipes: 15% Appurtenances: 30%
Pipe sizing method for distribution system and water heating plant	CPC Appendix A	CPC Appendix A
Balancing valve configurations	Manual balancing valves set to have 0.5 GPM recirculation flow per riser	Manual balancing valves set to have 0.5 GPM recirculation flow per riser
Recirculation flow controls	None	None

4.3.1.2 Energy Savings Methodology per Prototypical Building

First, The Statewide CASE Team calculated savings by fuel type. Electricity savings are measured in terms of both energy usage and peak demand reduction. Natural gas savings are quantified in terms of energy usage. The Statewide CASE Team, for each prototypical multifamily building, used the spreadsheet calculator to obtain hourly recirculation pipe heat loss for both the base case and proposed recirculation system. It calculated the corresponding hourly DHW system energy consumption (Therm for natural gas systems and kWh for HPWH systems) by dividing the hourly recirculation pipe heat loss by the heating plant efficiency. The Statewide CASE Team obtained annual site energy consumption for recirculation system operation by summing up the hourly DHW system energy consumption for the whole year. It calculated the first-year site energy savings (Therms/yr for natural gas systems and kWh/yr for HPWH systems) of the proposed code change as the difference in annual site energy consumption between the proposed and base case recirculation systems.

The Statewide CASE Team calculated, for both the base case and proposed recirculation systems, annual peak electricity demand (kW) based on weighted average of hourly kWh consumption during grid peak hours. The CEC provided both peak hours and corresponding weighting factors. Then, the Statewide CASE Team calculated annual peak reduction (kW) of the proposed code change as the difference in annual peak electricity demand between the base case and proposed recirculation systems.

Second, the Statewide CASE Team calculated source energy savings. Source energy represents the total amount of raw fuel required to operate a building. In addition to all energy used from on-site production, source energy incorporates all transmission, delivery, and production losses. The CEC provided hourly source energy factors, which are strongly correlated with GHG emissions. The Statewide CASE Team calculated source energy use in kilo British thermal units per year (kBtu/yr) by applying source energy factors to hourly DHW system energy consumption and summing the hourly results for the whole year. Source energy savings is calculated as the difference in source energy use between the base and the proposed cases.

The hourly source energy values provided by the CEC are strongly correlated with GHG emissions.³⁸ The Statewide CASE Team calculated GHG emissions (metric tons of carbon dioxide emissions equivalent) by applying hourly GHG emissions factors to hourly DHW system energy consumption and summing the hourly results for the whole year. GHG emissions reduction is calculated as the difference in GHG emissions between the base and the proposed cases.

³⁸ See hourly factors for source energy, LSC, and GHG emissions at <https://www.energy.ca.gov/files/2025-energy-code-hourly-factors>

Finally, the Statewide CASE Team calculated LSC savings, formerly known as TDV energy cost savings. LSC Savings are calculated using hourly energy cost metrics for both electricity and natural gas provided by the CEC. These LSC hourly factors are projected over the 30-year life of the building, and incorporates the hourly cost of marginal generation, transmission and distribution, fuel, capacity, losses, and cap-and-trade-based CO2 emissions. The Statewide CASE Team applied 2025 LSC hourly factors to hourly DHW system energy consumption and summed up hourly results for the whole year to obtain LSC in 2026 PV\$. LSC Savings are the difference in LSC between the base and proposed cases.

Table 67: Prototype Buildings Used for Energy, Demand, Cost, and Environmental Impacts Analysis

Prototype Name	Number of Stories	Floor Area (Square Feet)	Description
LowRise Garden	2	7,680	8-unit apartment building. Gas fired and HPWH central DHW heater serving a central recirculation loop. Water heater is located on one end the of building at the ground level. Distribution piping runs horizontally in ceiling of ground floor, vertically up four risers, and returns in the ceiling of the second floor. ³⁹
Loaded Corridor	3	40,000	36-unit apartment building. Gas fired and HPWH central DHW heater serving a central recirculation loop. Water heater is located in a mechanical room at the ground level. Distribution piping runs horizontally in ceiling of ground floor, vertically up 13 risers, and returns in the ceiling of the third floor.
MidRise MixedUse	5	113,100	(4-story residential, 1-story commercial), 88-unit building. Gas fired and HPWH central DHW heater serving dwelling units from a central recirculation loop. Water heater is located in a mechanical room at the ground level (commercial level). Distribution piping runs horizontally in ceiling of second floor (first residential level), vertically up 22 risers, and returns in the ceiling of the fifth floor
HighRise MixedUse	10	125,400	10-story (9-story residential, 1-story commercial), Gas fired and HPWH central DHW heater serving dwelling units from a central recirculation loop. Water heater is located on the roof. Distribution piping runs horizontally in ceiling of top floor, vertically down 26 risers. There are two pressure zones divided vertically, each with horizontal supply and return piping.

³⁹ This DHW Distribution CASE topic and the Central HPWH CASE topic are analyzing a central system in the Low-Rise Garden prototype. The Low-Rise Garden prototype for other CASE topics assumes individual water heaters for each dwelling unit.

The Proposed Design was identical to The Standard Design in all ways except for the revisions that represent the proposed changes to the code. Table 68 presents precisely which parameters were modified and what values were used in the Standard Design and Proposed Design. Specifically, the proposed condition assumes an increase of 15 percentage points of the total recirculation pipe surface area from the base case.

Table 68: Modifications Made to Standard Design in Each Prototype to Simulate Proposed Code Change

Prototype ID	Climate Zone	Objects Modified	Parameter Name	Standard Design Parameter Value	Proposed Design Parameter Value
LowRiseGarden	All	DHW Distribution	Uninsulated Pipe	52%	37%
LoadedCorridor	All	DHW Distribution	Uninsulated Pipe	43%	28%
MidRiseMixedUse	All	DHW Distribution	Uninsulated Pipe	38.5%	23.5%
HighRiseMixedUse	All	DHW Distribution	Uninsulated Pipe	43%	28%

The Statewide CASE Team calculates whole-building energy consumption for every hour of the year measured in kilowatt-hours per year (kWh/yr) and therms per year (therms/yr). It then applies the 2025 LSC hourly factors to calculate LSC savings in 2026 PV\$, source energy factors to calculate source energy use in kilo British thermal units per year (kBtu/yr), and hourly GHG emissions factors to calculate annual GHG emissions in metric tons of carbon dioxide emissions equivalent.

The energy impacts of the proposed code change vary by climate zone. However, the variations in site energy savings are small (less than one percent). For the loaded corridor prototype building, the Statewide CASE Team assessed the energy impacts in every climate zone and applied the climate-zone specific LSC hourly factors when calculating energy and energy cost impacts. The variations in site energy savings are small (less than one percent). Therefore, for the other three prototype buildings, the Statewide CASE Team assessed the energy impacts for four representative climate zones: 3, 9, 12, and 15, and then extrapolated to the other climate zones according to the variation among climate zones for the base case.

Based on the energy analysis, the proposed case with uniform pipe insulation and installation verification resulted in significant increase in energy savings across different prototype building types and heating plant types. Table 69 summarizes the modeling results for pipe heat loss savings in column 1 for distribution, and column 2 and 3 for the gas water heater and HPWH based heating plant pipe heat loss savings from the base to proposed case. Columns 4 and 5 total the gas and HPWH total DHW system pipe heat loss savings when including the heat loss savings for the distribution piping.

Table 69: Resulting Pipe Heat Loss Savings after Modeling Proposed Code Change

Building type	Distribution Pipe Heat Loss Savings	Gas WH Heating Plant Pipe Heat Loss Savings	HPWH Heating Plant Pipe Heat Loss Savings	Gas DHW system Pipe Heat Loss Savings	HPWH DHW system Pipe Heat Loss Savings
Low-Rise Garden	14.0%	44.7%	36.0%	28.9%	24.3%
Low-Rise Loaded Corridor	17.0%	45.1%	40.0%	27.7%	24.4%
Mid-Rise Mixed Use	19.0%	48.9%	45.0%	28.2%	24.6%
High-Rise Mixed Use	17.0%	50.9%	47.0%	30.5%	25.5%

Per-unit energy impacts for multifamily buildings are presented in savings per residential unit. Annual energy and peak demand impacts for each prototype building were translated into impacts per dwelling unit by dividing by the number of dwelling units in the prototype building. This step enables a calculation of statewide savings using the construction forecast that is published in terms of number of multifamily dwelling units by climate zone.

4.3.1.3 Statewide Energy Savings Methodology

The per-unit energy impacts were extrapolated to statewide impacts using the Statewide Construction Forecasts that the CEC provided. The Statewide Construction Forecasts estimate new construction/additions that would occur in 2026, the first year that the 2025 Title 24, Part 6 requirements are in effect (California Energy Commission 2022). The construction forecast provides construction (new construction/additions and existing building stock) by building type and climate zone, as shown in Appendix A.

Appendix A: Statewide Savings Methodology presents additional information about the methodology and assumptions used to calculate statewide energy impacts.

4.3.2 Per-Unit Energy Impacts Results

Energy savings and peak demand reductions per unit are presented in Table 70 through Table 75. The per-unit energy savings figures do not account for naturally occurring market adoption or compliance rates.

For HPWH-Pipe Insulation LowRiseGarden, per-unit annual savings are expected to range from 229 to 256 kWh/unit depending upon climate zones. There is no gas usage in all climate zones for both base case and proposed case. Demand reductions are expected to range between 28 kW and 30 kW depending on the climate zone.

For HPWH-Pipe Insulation LoadedCorridor, per-unit annual savings are expected to range from 159 to 184 kWh/unit depending upon climate zones. There is no gas usage

in all climate zones for both base case and proposed case. Demand reductions are expected to range between 20 kW and 21 kW depending on the climate zone.

For HPWH-Pipe Insulation MidRiseMixedUse, per-unit annual savings are expected to range from 165 to 192 kWh/unit depending upon climate zones. There is no gas usage in all climate zones for both base case and proposed case. Demand reductions are expected to range between 19 kW and 23 kW depending on the climate zone.

For HPWH-Pipe Insulation HighRiseMixedUse, per-unit annual savings are expected to range from 154 to 177 kWh/unit depending upon climate zones. There is no gas usage in all climate zones for both base case and proposed case. Demand reductions are expected to range between 18 kW and 21 kW depending on the climate zone.

For Gas-Pipe Insulation LowRiseGarden, there are no per-unit electricity saving in all climate zones for the base case. The per-unit natural gas savings range from 2291 to 2406. There are no demand reductions for any of the climate zones.

For Gas-Pipe Insulation LoadedCorridor, there are no per-unit electricity saving in all climate zones for the base case. The per-unit natural gas savings range from 1345 to 1448. There are no demand reductions for any of the climate zones.

For Gas-Pipe Insulation MidRiseMixedUse, there are no per-unit electricity saving in all climate zones for the base case. The per-unit natural gas savings range from 1337 to 1607. There are no demand reductions for any of the climate zones.

For Gas-Pipe Insulation HighRiseMixedUse, there are no per-unit electricity saving in all climate zones for the base case. The per-unit natural gas savings range from 1524 to 1622. There are no demand reductions for any of the climate zones.

Table 70: Annual Electricity Savings (kWh) Per Dwelling Unit – HPWH-Pipe Insulation

Prototype	CZ 1	CZ 2	CZ 3	CZ 4	CZ 5	CZ 6	CZ 7	CZ 8	CZ 9	CZ 10	CZ 11	CZ 12	CZ 13	CZ 14	CZ 15	CZ 16
LowRiseGarden	256	242	244	241	250	239	236	235	236	237	240	240	239	239	229	244
LoadedCorridor	184	171	172	170	178	168	166	165	166	167	169	169	168	169	159	173
MidRiseMixedUse	192	178	180	177	186	175	172	171	172	173	176	176	175	175	165	180
HighRiseMixedUse	177	166	167	164	172	163	160	160	160	161	164	164	163	163	154	167

Table 71: Annual Peak Demand Reduction (kW) Per Dwelling Unit – HPWH-Pipe Insulation

Prototype	CZ 1	CZ 2	CZ 3	CZ 4	CZ 5	CZ 6	CZ 7	CZ 8	CZ 9	CZ 10	CZ 11	CZ 12	CZ 13	CZ 14	CZ 15	CZ 16
LowRiseGarden	30	28	28	28	29	28	28	28	28	28	28	28	28	28	28	29
LoadedCorridor	21	20	20	20	21	20	20	20	20	20	20	20	20	20	20	20
MidRiseMixedUse	23	21	21	21	22	21	20	20	20	20	21	21	21	21	19	21
HighRiseMixedUse	21	19	20	19	20	19	19	19	19	19	19	19	19	19	18	20

Table 72: Annual Source Energy Savings (kBtu) Per Dwelling Unit – HPWH-Pipe Insulation

Prototype	CZ 1	CZ 2	CZ 3	CZ 4	CZ 5	CZ 6	CZ 7	CZ 8	CZ 9	CZ 10	CZ 11	CZ 12	CZ 13	CZ 14	CZ 15	CZ 16
LowRiseGarden	445	421	423	418	435	415	410	409	414	412	417	420	415	416	402	424
LoadedCorridor	314	300	301	298	308	297	291	292	293	295	298	298	297	298	282	302
MidRiseMixedUse	337	312	314	309	326	306	301	300	301	303	308	308	306	307	288	315
HighRiseMixedUse	310	289	291	287	301	284	280	279	280	282	285	286	284	285	269	292

Table 73: Annual LSC Savings (2026 PV\$) Per Dwelling Unit – HPWH-Pipe Insulation

Prototype	CZ 1	CZ 2	CZ 3	CZ 4	CZ 5	CZ 6	CZ 7	CZ 8	CZ 9	CZ 10	CZ 11	CZ 12	CZ 13	CZ 14	CZ 15	CZ 16
LowRiseGarden	1,728	1,636	1,644	1,620	1,686	1,615	1,581	1,587	1,596	1,599	1,613	1,617	1,603	1,612	1,547	1,654
LoadedCorridor	1,233	1,160	1,165	1,145	1,200	1,141	1,111	1,118	1,122	1,128	1,140	1,141	1,134	1,139	1,078	1,173
MidRiseMixedUse	1,301	1,206	1,215	1,190	1,258	1,183	1,152	1,155	1,160	1,167	1,183	1,184	1,173	1,181	1,107	1,222
HighRiseMixedUse	1,198	1,119	1,126	1,106	1,162	1,101	1,074	1,077	1,082	1,087	1,100	1,101	1,092	1,099	1,037	1,133

Table 74: Annual Natural Gas Savings (kBtu) Per Dwelling Unit – Gas-Pipe Insulation

Prototype	CZ 1	CZ 2	CZ 3	CZ 4	CZ 5	CZ 6	CZ 7	CZ 8	CZ 9	CZ 10	CZ 11	CZ 12	CZ 13	CZ 14	CZ 15	CZ 16
LowRiseGarden	2,406	2,348	2,354	2,342	2,381	2,334	2,322	2,319	2,322	2,327	2,338	2,338	2,333	2,336	2,291	2,355
LoadedCorridor	1,448	1,396	1,401	1,390	1,426	1,383	1,372	1,370	1,373	1,377	1,387	1,387	1,382	1,385	1,345	1,402
MidRiseMixedUse	1,427	1,367	1,373	1,360	1,401	1,352	1,340	1,337	1,591	1,345	1,356	1,607	1,351	1,354	1,559	1,374
HighRiseMixedUse	1,622	1,573	1,577	1,567	1,601	1,560	1,550	1,548	1,551	1,554	1,564	1,564	1,559	1,562	1,524	1,579

Table 75: Annual Source Energy Savings (kBtu) Per Dwelling Unit – Gas-Pipe Insulation

Prototype	CZ 1	CZ 2	CZ 3	CZ 4	CZ 5	CZ 6	CZ 7	CZ 8	CZ 9	CZ 10	CZ 11	CZ 12	CZ 13	CZ 14	CZ 15	CZ 16
LowRiseGarden	2179	2126	2131	2120	2156	2100	2081	2086	2089	2093	2117	2117	2112	2101	2061	2119
LoadedCorridor	1311	1264	1268	1259	1291	1244	1230	1232	1235	1239	1256	1256	1251	1246	1210	1262
MidRiseMixedUse	1292	1238	1243	1232	1268	1217	1201	1202	1431	1210	1228	1455	1223	1218	1402	1236
HighRiseMixedUse	1469	1424	1428	1419	1449	1404	1390	1392	1395	1398	1416	1416	1412	1405	1371	1420

Table 76: Annual LSC Savings (2026 PV\$) Per Dwelling Unit – Gas-Pipe Insulation

Prototype	CZ 1	CZ 2	CZ 3	CZ 4	CZ 5	CZ 6	CZ 7	CZ 8	CZ 9	CZ 10	CZ 11	CZ 12	CZ 13	CZ 14	CZ 15	CZ 16
LowRiseGarden	2,868	2,798	2,805	2,791	2,838	2,785	2,776	2,767	2,772	2,776	2,786	2,787	2,780	2,787	2,734	2,810
LoadedCorridor	1,724	1,665	1,671	1,658	1,699	1,652	1,642	1,636	1,639	1,644	1,654	1,655	1,649	1,654	1,605	1,674
MidRiseMixedUse	1,702	1,630	1,637	1,622	1,671	1,615	1,603	1,596	1,899	1,606	1,618	1,916	1,611	1,617	1,861	1,641
HighRiseMixedUse	1,934	1,875	1,880	1,868	1,908	1,863	1,854	1,847	1,851	1,855	1,864	1,864	1,859	1,865	1,819	1,884

4.4 Cost and Cost-Effectiveness

4.4.1 Energy Cost Savings Methodology

Energy cost savings were calculated by applying the LSC hourly factors to the energy savings estimates that were derived using the methodology described in Section 4.3.1. LSC hourly factors are a normalized metric to calculate energy cost savings that accounts for the variable cost of electricity and natural gas for each hour of the year, along with how costs are expected to change over 30-year period of analysis.

The CEC requested LSC savings over the 30-year period of analysis in both 2026 PV\$ and nominal dollars. The cost-effectiveness analysis uses LSC values in 2026 PV\$. Costs and cost-effectiveness using 2026 PV\$ are presented in Section 4.4.5 of this report. The CEC uses results in nominal dollars to complete the Economic and Fiscal Impacts Statement (From 399) for the entire package of proposed change to Title 24, Part 6. Appendix G: Energy Cost Savings in Nominal Dollars presents LSC savings results in nominal dollars.

This proposed code change does not apply to additions and/or alterations.

4.4.2 Energy Cost Savings Results

Per-unit energy cost savings for newly constructed buildings in terms of LSC savings realized over the 30-year period of analysis are presented in 2026 PV\$ in Table 77 through Table 84. The results show a range of savings ranging from \$1,000 to \$2,900 depending on the prototype building and gas or electric HP based DHW system.

The LSC methodology allows peak electricity savings to be valued more than electricity savings during non-peak periods. This measure addresses energy savings both during peak and non-peak hours.

Any time code changes impact cost, there is potential to disproportionately impact DIPs. Refer to Section 4.6 for more details addressing energy equity and environmental justice.

Table 77: 2026 PV 30-year LSC Savings – Per Dwelling Unit – New Construction and Additions – LowRiseGarden – HPWH-Pipe Insulation

Climate Zone	30-Year LSC Electricity Savings (2026 PV \$)	30-Year LSC Gas Savings (2026 PV \$)	Total 30-Year LSC Savings (2026 PV \$)
1	\$1,728	\$0	\$1,728
2	\$1,636	\$0	\$1,636
3	\$1,644	\$0	\$1,644
4	\$1,620	\$0	\$1,620
5	\$1,686	\$0	\$1,686
6	\$1,615	\$0	\$1,615
7	\$1,581	\$0	\$1,581
8	\$1,587	\$0	\$1,587
9	\$1,596	\$0	\$1,596
10	\$1,599	\$0	\$1,599
11	\$1,613	\$0	\$1,613
12	\$1,617	\$0	\$1,617
13	\$1,603	\$0	\$1,603
14	\$1,612	\$0	\$1,612
15	\$1,547	\$0	\$1,547
16	\$1,654	\$0	\$1,654

Table 78: 2026 PV 30-year LSC Savings – Per Dwelling Unit – New Construction and Additions – LoadedCorridor – HPWH-Pipe Insulation

Climate Zone	30-Year LSC Electricity Savings (2026 PV \$)	30-Year LSC Gas Savings (2026 PV \$)	Total 30-Year LSC Savings (2026 PV \$)
1	\$1,233	\$0	\$1,233
2	\$1,160	\$0	\$1,160
3	\$1,165	\$0	\$1,165
4	\$1,145	\$0	\$1,145
5	\$1,200	\$0	\$1,200
6	\$1,141	\$0	\$1,141
7	\$1,111	\$0	\$1,111
8	\$1,118	\$0	\$1,118
9	\$1,122	\$0	\$1,122
0	\$1,128	\$0	\$1,128
11	\$1,140	\$0	\$1,140
12	\$1,141	\$0	\$1,141
13	\$1,134	\$0	\$1,134
14	\$1,139	\$0	\$1,139
15	\$1,078	\$0	\$1,078
16	\$1,173	\$0	\$1,173

Table 79: 2026 PV 30-year LSC Savings – Per Dwelling Unit – New Construction and Additions – MidRiseMixedUse – HPWH-Pipe Insulation

Climate Zone	30-Year LSC Electricity Savings (2026 PV \$)	30-Year LSC Gas Savings (2026 PV \$)	Total 30-Year LSC Savings (2026 PV \$)
01	\$1,301	\$0	\$1,301
02	\$1,206	\$0	\$1,206
03	\$1,215	\$0	\$1,215
04	\$1,190	\$0	\$1,190
05	\$1,258	\$0	\$1,258
06	\$1,183	\$0	\$1,183
07	\$1,152	\$0	\$1,152
08	\$1,155	\$0	\$1,155
09	\$1,160	\$0	\$1,160
10	\$1,167	\$0	\$1,167
11	\$1,183	\$0	\$1,183
12	\$1,184	\$0	\$1,184
13	\$1,173	\$0	\$1,173
14	\$1,181	\$0	\$1,181
15	\$1,107	\$0	\$1,107
16	\$1,222	\$0	\$1,222

Table 80: 2026 PV 30-year LSC Savings – Per Dwelling Unit – New Construction and Additions – HighRiseMixedUse – HPWH-Pipe Insulation

Climate Zone	30-Year LSC Electricity Savings (2026 PV \$)	30-Year LSC Gas Savings (2026 PV \$)	Total 30-Year LSC Savings (2026 PV \$)
1	\$1,198	\$0	\$1,198
2	\$1,119	\$0	\$1,119
3	\$1,126	\$0	\$1,126
4	\$1,106	\$0	\$1,106
5	\$1,162	\$0	\$1,162
6	\$1,101	\$0	\$1,101
7	\$1,074	\$0	\$1,074
8	\$1,077	\$0	\$1,077
9	\$1,082	\$0	\$1,082
10	\$1,087	\$0	\$1,087
11	\$1,100	\$0	\$1,100
12	\$1,101	\$0	\$1,101
13	\$1,092	\$0	\$1,092
14	\$1,099	\$0	\$1,099
15	\$1,037	\$0	\$1,037
16	\$1,133	\$0	\$1,133

Table 81: 2026 PV 30-year LSC Savings – Per Dwelling Unit – New Construction and Additions – LowRiseGarden – Gas-Pipe Insulation

Climate Zone	30-Year LSC Electricity Savings (2026 PV \$)	30-Year LSC Gas Savings (2026 PV \$)	Total 30-Year LSC Savings (2026 PV \$)
1	\$0	\$2,868	\$2,868
2	\$0	\$2,798	\$2,798
3	\$0	\$2,805	\$2,805
4	\$0	\$2,791	\$2,791
5	\$0	\$2,838	\$2,838
6	\$0	\$2,785	\$2,785
7	\$0	\$2,776	\$2,776
8	\$0	\$2,767	\$2,767
9	\$0	\$2,772	\$2,772
10	\$0	\$2,776	\$2,776
11	\$0	\$2,786	\$2,786
12	\$0	\$2,787	\$2,787
13	\$0	\$2,780	\$2,780
14	\$0	\$2,787	\$2,787
15	\$0	\$2,734	\$2,734
16	\$0	\$2,810	\$2,810

Table 82: 2026 PV 30-year LSC Savings – Per Dwelling Unit – New Construction and Additions – LoadedCorridor – Gas-Pipe Insulation

Climate Zone	30-Year LSC Electricity Savings (2026 PV \$)	30-Year LSC Gas Savings (2026 PV \$)	Total 30-Year LSC Savings (2026 PV \$)
1	\$0	\$1,724	\$1,724
2	\$0	\$1,665	\$1,665
3	\$0	\$1,671	\$1,671
4	\$0	\$1,658	\$1,658
5	\$0	\$1,699	\$1,699
6	\$0	\$1,652	\$1,652
7	\$0	\$1,642	\$1,642
8	\$0	\$1,636	\$1,636
9	\$0	\$1,639	\$1,639
10	\$0	\$1,644	\$1,644
11	\$0	\$1,654	\$1,654
12	\$0	\$1,655	\$1,655
13	\$0	\$1,649	\$1,649
14	\$0	\$1,654	\$1,654
15	\$0	\$1,605	\$1,605
16	\$0	\$1,674	\$1,674

Table 83: 2026 PV 30-year LSC Savings – Per Dwelling Unit – New Construction and Additions – MidRiseMixedUse – Gas-Pipe Insulation

Climate Zone	30-Year LSC Electricity Savings (2026 PV \$)	30-Year LSC Gas Savings (2026 PV \$)	Total 30-Year LSC Savings (2026 PV \$)
1	\$0	\$1,702	\$1,702
2	\$0	\$1,630	\$1,630
3	\$0	\$1,637	\$1,637
4	\$0	\$1,622	\$1,622
5	\$0	\$1,671	\$1,671
6	\$0	\$1,615	\$1,615
7	\$0	\$1,603	\$1,603
8	\$0	\$1,596	\$1,596
9	\$0	\$1,899	\$1,899
10	\$0	\$1,606	\$1,606
11	\$0	\$1,618	\$1,618
12	\$0	\$1,916	\$1,916
13	\$0	\$1,611	\$1,611
14	\$0	\$1,617	\$1,617
15	\$0	\$1,861	\$1,861
16	\$0	\$1,641	\$1,641

Table 84: 2026 PV 30-year LSC Savings – Per Dwelling Unit – New Construction and Additions – HighRiseMixedUse – Gas-Pipe Insulation

Climate Zone	30-Year LSC Electricity Savings (2026 PV \$)	30-Year LSC Gas Savings (2026 PV \$)	Total 30-Year LSC Savings (2026 PV \$)
1	\$0	\$1,934	\$1,934
2	\$0	\$1,875	\$1,875
3	\$0	\$1,880	\$1,880
4	\$0	\$1,868	\$1,868
5	\$0	\$1,908	\$1,908
6	\$0	\$1,863	\$1,863
7	\$0	\$1,854	\$1,854
8	\$0	\$1,847	\$1,847
9	\$0	\$1,851	\$1,851
10	\$0	\$1,855	\$1,855
11	\$0	\$1,864	\$1,864
12	\$0	\$1,864	\$1,864
13	\$0	\$1,859	\$1,859
14	\$0	\$1,865	\$1,865
15	\$0	\$1,819	\$1,819
16	\$0	\$1,884	\$1,884

4.4.3 Incremental First Cost

4.4.3.1 Background on Basis of Design

Incremental first cost is the initial cost to adopt more efficient equipment or building practices as compared to the cost of an equivalent baseline project. The Statewide CASE Team considers first costs in evaluating overall measure Cost-Effectiveness. Incremental first costs are based on project data currently available, interviews, and standard practice in the multifamily construction.

The Statewide CASE Team developed a heating plant and distribution system piping for each prototype and worked with one mechanical contractor to estimate the costs for the base case and proposed case design. Based on the plumbing designs, the Statewide CASE Team calculated the total length of pipe for each pipe size for each prototype building in the base case and the proposed case for the hot water distribution system. These piping calculations are detailed in Appendix I.

The CPC Appendix A pipe diameter, length of pipe and list of appurtenances is used by the contractors for calculation of pipe insulation base and proposed case installed cost. The mechanical contractors provided pipe insulation material and labor cost estimates for complete installation of the hot water distribution piping, heating plant piping and associated appurtenances, fittings, and pipe supports. The cost estimate includes associated overhead, design and engineering, permit, testing, and inspection, and a contractor profit or market factor.

4.4.3.2 Pipe Insulation Language Cleanup

The Statewide CASE Team determined the incremental cost for the pipe insulation language updates, including additional insulation for fittings and appurtenances in both the distribution system and heating plant sections beyond current base case piping insulation requirements.

The Statewide CASE Team calculated the total pipe length for the distribution hot water and recirculation piping from the building prototype designs which are represented in Table 85. Note that both a gas and heat pump water heating system were considered and analyzed separately.

Table 85: Total Length (Feet) of Each Pipe Size - Base and Proposed Case Design

Design	Pipe Diameter	Total Piping Length (ft)	Number of Pipe Supports
Baseline Distribution Supply and Return	4"	53	7
	3"	91	11
	2.5"	73	9
	2"	85	11
	1.5"	939	117
	1.25"	0	0
	1"	338	42
	0.75"	744	93
	0.5"	0	0
	All	2,323	290
Baseline Gas Water Heater Plant	6"	0	NA
	5"	0	NA
	4"	68	NA
	3"	48	NA
	2.5"	0	NA
	2"	12	NA
	1.5"	0	NA
	1.25"	0	NA
	1"	0	NA
	0.75"	0	NA
	0.5"	0	NA
	All	128	NA
Baseline Heat Pump Water Heater Plant	6"	0	NA
	5"	0	NA
	4"	68	NA
	3"	12	NA
	2.5"	0	NA
	2"	12	NA
	1.5"	12	NA
	1.25"	0	NA
	1"	24	NA
	0.75"	0	NA
	0.5"	0	NA
	All	128	NA
Baseline Gas Water Heater Plant	Total	2,451	290
Baseline Heat Pump Water Heater Plant	Total	2,451	290

The Statewide CASE Team calculated the total number of appurtenances for the distribution and heating plant systems for each building prototype, shown in Table 86 through Table 88. Due to the complexity of the piping system in the heating plants, there are significantly more appurtenances. The heating plant appurtenances are generally larger in physical size than the distribution system appurtenances and collectively represent a significant opportunity to save energy by ensuring that they are insulated.

Table 86: Total Appurtenance (Piping Specialty) Count - Distribution System

Type	Pipe Size	# Ball Valves	# Balancing Valves	# Vents	# Pipe Supports
Low-Rise Garden Style	1/2"	0	0	1	0
	3/4"	10	4	0	21
	1"	1	0	0	4
	1 1/4"	0	0	0	0
	1 1/2"	0	0	0	7
	2"	0	0	0	3
	2 1/2"	0	0	0	0
	3"	0	0	0	0
Low-Rise Loaded Corridor	1/2"	0	0	3	0
	3/4"	12	12	0	56
	1"	3	0	0	23
	1 1/4"	0	0	0	0
	1 1/2"	9	0	0	19
	2"	0	0	0	3
	2 1/2"	0	0	0	11
	3"	0	0	0	3
Mid-Rise Mixed Use	1/2"	0	0	5	0
	3/4"	22	22	0	93
	1"	0	0	0	42
	1 1/4"	0	0	0	0
	1 1/2"	22	0	0	117
	2"	0	0	0	11
	2 1/2"	0	0	0	9
	3"	0	0	0	11
High-Rise Mixed Use	4"	0	0	0	7
	2"	0	0	0	7
	2 1/2"	0	0	0	21
	3"	0	0	0	16
	4"	0	0	0	1

Table 87: Total Appurtenance (Piping Specialty) Count - Gas Heating Plant System

Type	Pipe Size	# Ball Valves	# Bal. Valves	# PRV	# Check Valves	# Wyes	# Hose Bibbs	# 90°	# Tees	# Man. Vent	# DE Union	# Pumps
Low-Rise Garden Style	1/2"	0	0	0	0	0	0	0	0	0	0	0
	3/4"	5	2	0	4	0	1	0	2	1	0	1
	1"	0	0	2	0	0	0	0	0	0	0	0
	1 1/2"	3	0	0	1	2	2	15	7	0	1	1
	2"	6	0	0	1	1	0	15	1	2	8	0
	2 1/2"	0	0	0	0	0	0	0	0	0	0	0
	3"	0	0	0	0	0	0	0	0	0	0	0
	4"	0	0	0	0	0	0	0	0	0	0	0
	5"	0	0	0	0	0	0	0	0	0	0	0
Low-Rise Loaded Corridor	1/2"	0	0	0	0	0	0	0	0	0	0	0
	3/4"	6	0	0	0	0	0	0	0	0	0	0
	1"	0	2	3	3	0	1	0	1	1	0	1
	1 1/2"	0	0	0	0	0	0	0	0	0	0	0
	2"	5	0	0	3	4	4	19	3	0	1	2
	2 1/2"	0	0	0	0	0	0	0	0	0	0	0
	3"	8	0	0	1	1	0	22	11	2	11	0
	4"	0	0	0	0	0	0	0	0	0	0	0
	5"	0	0	0	0	0	0	0	0	0	0	0
Mid-Rise Mixed Use	1/2"	0	0	0	0	0	0	0	0	0	0	0
	3/4"	5	0	0	0	0	0	0	0	0	0	0
	1"	0	0	4	0	0	0	0	0	0	0	0
	1 1/2"	0	0	0	0	0	0	0	0	0	0	0
	2"	2	2	0	4	0	1	0	2	1	0	1
	2 1/2"	0	0	0	0	0	0	0	0	0	0	0
	3"	7	0	0	3	6	6	27	4	0	1	3
	4"	10	0	0	1	1	0	25	14	2	14	0
	5"	0	0	0	0	0	0	0	0	0	0	0
High-Rise Mixed Use	1/2"	0	0	0	0	0	0	0	0	0	0	0
	3/4"	7	0	0	0	0	0	0	0	0	0	0
	1"	4	4	6	6	0	2	0	0	2	0	2
	1 1/2"	0	0	0	0	0	0	0	0	0	0	0
	2"	2	0	0	2	0	0	6	2	0	2	0
	2 1/2"	0	0	0	0	0	0	0	0	0	0	0
	3"	6	0	0	3	6	6	24	4	0	0	3
	4"	4	0	0	0	0	0	14	19	0	4	0
	5"	0	0	0	0	0	0	0	0	0	0	0
6"	12	0	0	1	2	0	26	1	2	18	0	

Table 88: Total Appurtenance (Piping Specialty) Count - HPWH Heating Plant System

Type	Pipe Size	# Ball Valves	# Bal. Valves	# PRV	# Check Valves	# Wyes	# Hose Bibbs	# 90°	# Tees	# Man. Vent	# DE Union	# Pumps
Low-Rise Garden Style	1/2"	2	0	0	1	1	2	12	2	0	0	0
	3/4"	5	2	0	4	0	1	0	2	1	0	1
	1"	0	0	2	0	0	0	0	0	0	0	0
	1 1/2"	1	0	0	0	0	0	3	0	0	1	0
	2"	6	0	0	1	1	0	21	2	2	6	0
	2 1/2"	0	0	0	0	0	0	0	0	0	0	0
	3"	0	0	0	0	0	0	0	0	0	0	0
	4"	0	0	0	0	0	0	0	0	0	0	0
	5"	0	0	0	0	0	0	0	0	0	0	0
Low-Rise Loaded Corridor	1/2"	10	0	0	5	5	10	40	8	0	0	0
	3/4"	5	0	0	0	0	0	4	0	0	0	0
	1"	0	2	2	3	0	1	0	1	1	0	1
	1 1/2"	0	0	0	0	0	0	0	0	0	0	0
	2"	1	0	0	1	0	0	3	1	0	1	0
	2 1/2"	0	0	0	0	0	0	0	0	0	0	0
	3"	6	0	0	1	1	0	21	2	2	6	0
	4"	0	0	0	0	0	0	0	0	0	0	0
	5"	0	0	0	0	0	0	0	0	0	0	0
Mid-Rise Mixed Use	1/2"	0	0	0	0	0	0	0	0	0	0	0
	3/4"	4	0	0	0	0	0	0	0	0	0	0
	1"	8	0	3	2	2	8	16	4	0	0	2
	1 1/2"	0	0	0	0	0	0	4	0	0	0	0
	2"	2	2	0	4	0	1	0	2	1	0	1
	2 1/2"	0	0	0	0	0	0	0	0	0	0	0
	3"	1	0	0	0	0	0	3	0	0	1	0
	4"	8	0	0	1	1	0	27	2	3	8	0
	5"	0	0	0	0	0	0	0	0	0	0	0
High-Rise Mixed Use	1/2"	0	0	0	0	0	0	0	0	0	0	0
	3/4"	5	0	0	0	0	0	0	0	0	0	0
	1"	12	4	4	8	2	10	16	4	2	0	4
	1 1/2"	0	0	0	0	0	0	4	0	0	0	0
	2"	2	0	0	2	0	0	6	2	0	2	0
	2 1/2"	0	0	0	0	0	0	0	0	0	0	0
	3"	0	0	0	0	0	0	12	0	0	0	0
	4"	8	0	0	0	0	0	22	2	2	8	0
	5"	0	0	0	0	0	0	0	0	0	0	0
6"	4	0	0	1	2	0	8	1	2	4	0	

The Statewide CASE Team received insulation material and labor costs for insulating piping and appurtenances from one mechanical contractor for the base and proposed cases for both gas and HPWH heating plants, as shown in Table 89 through Table 92. It should be noted that although the appurtenance counts were presented to the contractor for pricing and is shown here, the costs for insulation were presented as a total cost per foot of pipe and did not vary depending on appurtenance counts. The additional material and labor costs for the proposed case represent the additional material and labor hours required to insulate the appurtenances and pipe supports per the proposed pipe insulation language cleanup measure.

Costs proved by the contractor were received in dollars per foot of pipe including material and labor for complete installation, additionally a 10 percent overhead was added. To estimate the labor hours/labor cost, a 50/50 split was applied to the dollars per foot to separate materials and labor, then the 10 percent overhead was added to the calculated labor.

Table 89: Material and Labor Costs for Base Case (Gas Plant)

MF Building Type	Insulation Material Cost	Labor Hours	Labor Rate	Total
Low-Rise Garden Style	\$3,743	51	\$100	\$8,823
Low-Rise Loaded Corridor	\$10,587	130	\$100	\$23,544
Mid-Rise Mixed Use	\$26,722	311	\$100	\$57,848
High-Rise Mixed Use	\$28,616	338	\$100	\$62,427

Table 90: Material and Labor Costs for Proposed Case (Gas Plant)

MF Building Type	Insulation Material Cost	Labor Hours	Labor Rate	Total
Low-Rise Garden Style	\$4,252	56	\$100	\$9,843
Low-Rise Loaded Corridor	\$12,155	145	\$100	\$26,681
Mid-Rise Mixed Use	\$30,711	351	\$100	\$65,827
High-Rise Mixed Use	\$32,885	381	\$100	\$70,966

Table 91: Material and Labor Costs for Base Case (HPWH Plant)

MF Building Type	Insulation Material Cost	Labor Hours	Labor Rate	Total
Low-Rise Garden Style	\$3,803	53	\$100	\$9,070
Low-Rise Loaded Corridor	\$10,691	134	\$100	\$24,070
Mid-Rise Mixed Use	\$26,570	310	\$100	\$57,544
High-Rise Mixed Use	\$28,411	336	\$100	\$62,017

Table 92: Material and Labor Costs for Proposed Case (HPWH Plant)

MF Building Type	Insulation Material Cost	Labor Hours	Labor Rate	Total
Low-Rise Garden Style	\$4,324	58	\$100	\$10,113
Low-Rise Loaded Corridor	\$12,274	150	\$100	\$27,236
Mid-Rise Mixed Use	\$30,545	349	\$100	\$65,494
High-Rise Mixed Use	\$32,662	379	\$100	\$70,518

The Statewide CASE Team calculated the total incremental per building prototype for the gas and HPWH heating plants in Table 93 and Table 94, respectively. The last column shows the incremental cost per dwelling unit.

Table 93: Proposed Case Incremental Cost Per Prototype (Gas Plant)

MF Building Type	Baseline	Proposed	Total Incremental Cost	Average Incremental Cost per Dwelling Unit
Low-Rise Garden	\$8,823	\$9,843	\$1,020	\$127
Low-Rise Loaded Corridor	\$23,544	\$26,681	\$3,137	\$87
Mid-Rise Mixed Use	\$57,848	\$65,827	\$7,979	\$91
High-Rise Mixed Use	\$62,427	\$70,966	\$8,539	\$73

Table 94: Proposed Case Incremental Cost Per Prototype (HPWH Plant)

MF Building Type	Baseline	Proposed	Total Incremental Cost	Average Incremental Cost per Dwelling Unit
Low-Rise Garden	\$9,070	\$10,113	\$1,043	\$130
Low-Rise Loaded Corridor	\$24,070	\$27,236	\$3,166	\$88
Mid-Rise Mixed Use	\$57,544	\$65,494	\$7,950	\$90
High-Rise Mixed Use	\$62,017	\$70,518	\$8,501	\$73

4.4.3.3 Pipe Insulation Verification

The Statewide CASE Team estimated the pipe insulation verification first cost based on an interview with a HERS Raters manager on the verification process and associated labor hours. Because there is currently no requirement for field verification of pipe insulation, there is no cost for this in the base case.

The Statewide CASE Team interviewed a former manager of a HERS Raters team that worked on new construction and retrofit projects of single family and multifamily buildings. The Statewide CASE Team inquired about the typical verification process, time estimates to verify buildings of different floor areas, whether the HERS Raters

would charge an hourly rate or a flat fee per site visit, how long verification of a DHW distribution system would take, and whether construction phasing is an issue that impacts the verification process.

The Statewide CASE Team developed expected costs based on the HERS Rater manager interview. The Statewide CASE Team assumed that the cost for the pipe insulation verification is based on the floor area over which the verification takes place and the number of pipe risers. The Statewide CASE Team also assumed that a HERS Rater or an ATT would conduct the verification, and it assumed that the costs for HERS and ATT are comparable.

Based on the interview with the HERS Rater manager, the Statewide CASE Team assumed that a HERS Rater or ATT could verify 10,000 square feet of floor area in three and a half hours and would have a labor rate of \$250 per hour.

The Statewide CASE Team estimated first costs from inspecting a portion of the total piping that requires insulation for cost-effectiveness and statewide impacts analysis, because sampling addresses concerns about coordinating inspections with construction sequencing. The portions of piping are:

- Inspect all pipe insulation in the mechanical/boiler room where water heating equipment resides, or all outdoor pipes if the water heater is outdoors.
- Inspect all pipe insulation on horizontal distribution pipes that function as a supply header, up to the point of connection with riser pipes. Supply header is piping between the water heater and vertical risers that run up or down the building.
- Inspect a sample of pipe insulation on vertical pipe risers. The sample rate shall be one in two risers. Riser inspection shall include the entire vertical length of DHW recirculation riser pipe, including offsets and horizontal portions of recirculation loop, up to the point of connection of the branch pipe (non-recirculating) to dwelling units.

Table 95 shows the number of hours needed to verify each prototype for based on the assumption of the floor area a HERS Rater or ATT could verify in one hour and the number of risers.

Table 95: Total Verification Hours for Inspection by Prototype

Sample	Low-Rise Garden	Low-Rise Loaded Corridor	Mid-Rise	High-Rise
Verify First Level of Piping with 50% of Risers	2.6	13.8	39.8	43.9

Source: Statewide CASE Team

In addition to the labor cost of the verification, the Statewide CASE Team assumed the HERS Rater or ATT would travel an average of 100 miles to the building for each trip required, at a mileage rate of \$0.655. This results in a cost of \$65.50 per trip. To determine the number of trips required for each verification option and prototype, the Statewide CASE Team calculated the total number of hours needed to verify a building based on the three and a half hours per 10,000 square feet estimate above, in addition to assuming a HERS Rater/ATT would spend no more than five hours on site in a day. If nine hours were needed to verify a building, the Statewide CASE Team assumed two trips. Construction phasing could impact the number of trips required to complete an inspection. The Statewide CASE Team added an additional two trips per building to account for potential delays associated with construction phasing. Table 96 shows the number of trips required for each prototype.

Table 96: Number of Trips Required by Prototype – First level of piping with sampling of risers

Low-Rise Garden	Low-Rise Loaded Corridor	Mid-Rise	High-Rise
3	4	5	5

Source: Statewide CASE Team

Table 97 shows the total verification cost by building prototype based on these assumptions. Note that the total verification cost listed is the same as the incremental cost, because there is no cost for piping insulation verification in the base case. Option one costs are largest for Mid-Rise Mixed-Use prototype, because it has the largest number of hot water pipe risers.

Table 97: Total Verification Cost by Prototype

Costs	Low-Rise Garden	Low-Rise Loaded Corridor	Mid-Rise	High-Rise
Total Labor Cost	\$650	\$3,450	\$9,950	\$10,975
Total travel Cost	\$196.50	\$262	\$327.50	\$327.50
Total Cost	\$846.50	\$3,712	\$10,277.50	\$11,302.50
Average Cost per Dwelling Unit	\$106	\$103	\$117	\$97

Source: Statewide CASE Team

4.4.3.4 Total Incremental Cost

The Statewide CASE Team estimated the total pipe insulation enhancement incremental cost by combining the language cleanup and insulation verification first costs together in Table 98.

Table 98: Total Incremental Cost by Prototype Gas Heating Plant

MF Building Type	Language Cleanup	Pipe Insulation Verification	Total Incremental Cost	Average Incremental Cost per Dwelling Unit
Low-Rise Garden	\$808	\$847	\$1,655	\$207
Low-Rise Loaded Corridor	\$2,277	\$3,712	\$5,989	\$166
Mid-Rise Mixed Use	\$5,609	\$10,278	\$15,887	\$181
High-Rise Mixed Use	\$4,125	\$11,303	\$15,428	\$132

Table 99: Total Incremental Cost by Prototype HP Heating Plant

MF Building Type	Language Cleanup	Pipe Insulation Verification	Total Incremental Cost	Average Incremental Cost per Dwelling Unit
Low-Rise Garden	\$831	\$847	\$1,678	\$210
Low-Rise Loaded Corridor	\$2,306	\$3,712	\$6,018	\$167
Mid-Rise Mixed Use	\$5,580	\$10,278	\$15,858	\$180
High-Rise Mixed Use	\$5,865	\$11,303	\$17,168	\$147

4.4.4 Incremental Maintenance and Replacement Costs

Incremental maintenance cost is the incremental cost of replacing the equipment or parts of the equipment, as well as periodic maintenance required to keep the equipment operating relative to current practices over the 30-year period of analysis. There are no replacement costs for the proposed measure because the expected useful life of the measure and the impacted equipment is longer than the period of analysis. The periodic maintenance costs for the proposed measure are the same as for the base case; therefore, there are no associated incremental costs.

4.4.5 Cost-Effectiveness

This measure proposes a mandatory measure for code language cleanup and new language for pipe insulation verification. As such, a cost analysis is required to demonstrate that the measure is cost effective over the 30-year period of analysis.

The CEC establishes the procedures for calculating Cost-Effectiveness. The Statewide CASE Team collaborated with CEC staff to confirm that the methodology in this report is consistent with their guidelines, including which costs were included in the analysis. The incremental first cost and incremental maintenance costs over the 30-year period of analysis were included. The LSC savings from electricity and natural gas were also included in the evaluation. Design costs were not included nor were the incremental costs of code compliance verification.

According to the CEC’s definitions, a measure is cost effective if the B/C ratio is greater than 1.0. The B/C ratio is calculated by dividing the cost benefits realized over 30 years

by the total incremental costs, which includes maintenance costs for 30 years. The B/C ratio was calculated using 2026 PV costs and cost savings.

Results of the per-unit, cost-effectiveness analyses are presented in Table 100 and Table 101 for new construction. Benefits and costs are defined as follows:

- **Benefits: 30-year LSC Savings + Other PV Savings:** Benefits include LSC savings over the 30-year period of analysis (California Energy Commission 2022). Other savings are discounted at a real (nominal – inflation) three percent rate. Other PV savings include incremental first-cost savings if proposed first cost is less than current first cost, incremental PV maintenance cost savings if PV of proposed maintenance costs is less than PV of current maintenance costs, and incremental residual value if proposed residual value is greater than current residual value at end of CASE analysis period.
- **Costs: Total Incremental Present Valued Costs:** Costs include incremental equipment, replacement, and maintenance costs over the period of analysis if PV of proposed costs is greater than PV of current costs. Costs are discounted at a real (inflation-adjusted) three percent rate. If incremental maintenance cost is negative, it is treated as a positive benefit. If there are no total incremental PV costs, the B/C ratio is infinite.

Table 100: 30-Year Cost-Effectiveness Summary Per Dwelling Unit – New Construction – HPWH-Pipe Insulation

Climate Zone	Benefits: LSC Savings + Other PV Cost Savings (2026 PV\$/dwelling unit)	Costs: Total Incremental PV Costs (2026 PV\$/dwelling unit)	B/C Ratio
1	\$1,292	\$304	4
2	\$1,205	\$380	3
3	\$1,212	\$348	3
4	\$1,189	\$379	3
5	\$1,252	\$374	3
6	\$1,184	\$307	4
7	\$1,153	\$307	4
8	\$1,157	\$305	4
9	\$1,163	\$304	4
10	\$1,169	\$306	4
11	\$1,183	\$310	4
12	\$1,184	\$316	4
13	\$1,175	\$314	4
14	\$1,182	\$302	4
15	\$1,113	\$302	4
16	\$1,220	\$310	4
Total	\$1,176	\$320	4

Table 101: 30-Year Cost-Effectiveness Summary Per Dwelling Unit – New Construction – Gas-Pipe Insulation

Climate Zone	Benefits: LSC Savings + Other PV Cost Savings (2026 PV\$/dwelling unit)	Costs: Total Incremental PV Costs (2026 PV\$/dwelling unit)	B/C Ratio
1	\$1,754	\$303	6
2	\$1,687	\$379	4
3	\$1,693	\$346	5
4	\$1,679	\$378	4
5	\$1,725	\$373	5
6	\$1,673	\$305	5
7	\$1,662	\$306	5
8	\$1,655	\$303	5
9	\$1,832	\$302	6
10	\$1,664	\$304	5
11	\$1,675	\$308	5
12	\$1,848	\$314	6
13	\$1,669	\$312	5
14	\$1,675	\$301	6
15	\$1,795	\$301	6
16	\$1,697	\$309	5
Total	\$1,722	\$318	5

4.5 Annual Statewide Impacts

4.5.1 Statewide Energy and Energy Cost Savings

The Statewide CASE Team calculated the first-year statewide savings for new construction and additions by multiplying the per-unit savings, which are presented in Section 4.3.2, by assumptions about the percentage of newly constructed buildings that would be impacted by the proposed code. The statewide new construction forecast for 2026 is presented in Appendix A, as are the Statewide CASE Team’s assumptions about the percentage of new construction that would be impacted by the proposal (by climate zone and building type).

The first-year energy impacts represent the first-year annual savings from all buildings that were completed in 2026. The 30-year energy cost savings represent the energy cost savings over the entire 30-year analysis period. The statewide savings estimates do not take naturally occurring market adoption or compliance rates into account.

The tables below present the first-year statewide energy and energy cost savings from newly constructed buildings (Table 102) by climate zone.

While a statewide analysis is crucial to understanding broader effects of code change proposals, there is potential to disproportionately impact DIPs that needs to be considered. Refer to Section 4.6 for more details addressing energy equity and environmental justice.

Table 102: Statewide Energy and Energy Cost Impacts – New Construction and Additions - Pipe Insulation

Climate Zone	Statewide New Construction & Additions Impacted by Proposed Change in 2026 (Dwelling Units)	Annual ^a Electricity Savings (GWh)	Annual Peak Electrical Demand Reduction (MW)	Annual Natural Gas Savings (Million Therms)	Annual Source Energy Savings (Million kBtu)	30-Year Present Valued LSC Savings (Million 2026 PV\$)
1	96	0.00	0.00	0.00	0.11	\$0.16
2	923	0.03	0.00	0.01	1.03	\$1.48
3	5,110	0.16	0.02	0.06	5.72	\$8.23
4	2,268	0.07	0.01	0.03	2.52	\$3.62
5	189	0.01	0.00	0.00	0.22	\$0.31
6	1,489	0.04	0.01	0.02	1.63	\$2.37
7	3,422	0.10	0.01	0.04	3.71	\$5.39
8	5,708	0.17	0.02	0.07	6.19	\$8.96
9	6,837	0.20	0.02	0.09	8.18	\$11.74
10	2,858	0.08	0.01	0.03	3.12	\$4.51
11	779	0.02	0.00	0.01	0.86	\$1.24
12	3,675	0.11	0.01	0.05	4.47	\$6.37
13	670	0.02	0.00	0.01	0.74	\$1.06
14	960	0.03	0.00	0.01	1.05	\$1.53
15	248	0.01	0.00	0.00	0.29	\$0.42
16	124	0.00	0.00	0.00	0.14	\$0.20
Total	35,354	1.1	0.12	0.42	40.0	\$57.6

a. First-year savings from all buildings completed statewide in 2026.

4.5.2 Statewide GHG Emissions Reductions

The Statewide CASE Team calculated avoided GHG emissions associated with energy consumption using the hourly GHG emissions factors that the CEC developed along with the 2025 LSC hourly factors and an assumed cost of \$123.15 per metric ton of carbon dioxide equivalent emissions (metric tons CO₂e).

The monetary value of avoided GHG emissions is based on a proxy for permit costs (not social costs).⁴⁰ The cost-effectiveness analysis presented in Section 4.4.5 of this report does not include the cost savings from avoided GHG emissions. To demonstrate the cost savings of avoided GHG emissions, the Statewide CASE Team disaggregated the value of avoided GHG emissions from the other economic impacts. Table 103 presents the estimated first-year avoided GHG emissions of the proposed code change. During the first year, GHG emissions of 2,637 metric tons CO₂e would be avoided.

Table 103: First Year Statewide–GHG Emissions Impacts – Pipe Insulation

Measure	Electricity Savings ^a (GWh/yr)	Reduced GHG Emissions from Electricity Savings ^a (Metric Tons CO ₂ e)	Natural Gas Savings ^a (Million Therms/yr)	Reduced GHG Emissions from Natural Gas Savings ^a (Metric Tons CO ₂ e)	Total Reduced GHG Emissions ^a (Metric Ton CO ₂ e)	Total Monetary Value of Reduced GHG Emissions ^b (\$)
Pipe Insulation	1.1	97.7	0.42	2,539	2,637	\$324,700

a. First-year savings from all buildings completed statewide in 2026.

b. GHG emissions factors are included in the LSC hourly factors published by the CEC.

4.5.3 Statewide Water Use Impacts

Hot water piping is already required in existing code to be insulated including branches to dwelling units and twigs to individual sinks and equipment. New to code is insulation verification is required on heating plant and recirculation supply and return loop only. Also new is appurtenances are now required to be insulated at heating plant and recirculation loop, but not to the uncirculated branches or twigs leading to the dwelling units. The proposed code change would not result in water savings from minimal improvement in hot water delivery times at showers and sinks from a negligible reduction in pipe heat loss in uncirculated sections of branch and twig piping leading from the recirculation loop, especially since these sections cool off between draw periods. Thus, zero water savings can be associated with this proposed measure.

4.5.4 Statewide Material Impacts

Based on the code proposal, the insulation requirement increased which impacted the insulation material usage. The material impact is calculated for both the heat pump

⁴⁰ The permit cost of carbon is equivalent to the market value of a unit of GHG emissions in the California Cap-and-Trade program, while social cost of carbon is an estimate of the total economic value of damage done per unit of GHG emissions. Social costs tend to be greater than permit costs. See more on the Cap-and-Trade Program on the California Air Resources Board website: <https://ww2.arb.ca.gov/our-work/programs/cap-and-trade-program>.

water plant and gas water heater plant systems individually. See Appendix D for more details.

Table 104: Annual Statewide Impacts on Material Use – HPWH plant

Material	Impact	Per-Unit Impacts (Pounds per Dwelling Unit)	Annual ^a Statewide Impacts (Pounds)
Insulation	Increase	21.1	1,124,516
TOTAL	-	-	-

a. First-year savings from all buildings completed statewide in 2026.

Table 105: Annual Statewide Impacts on Material Use – Gas Water Heater plant

Material	Impact	Per-Unit Impacts (Pounds per Dwelling Unit)	Annual ^a Statewide Impacts (Pounds)
Others (Insulation)	Increase	21.6	1,151,248
TOTAL	-	-	-

a. First-year savings from all buildings completed statewide in 2026.

4.5.5 Other Non-Energy Impacts

There are no non-energy impacts.

4.6 Addressing Energy Equity and Environmental Justice

The Statewide CASE Team assessed the potential impacts of the proposed measure on DIPs. See Section 2 for a summary of research methods and potentially impacted populations, as well as other general potential equity impacts (CALEPA 2022).

4.6.1 Potential Impacts

This measure would result in higher construction costs, a reduction in energy costs, and improved hot water delivery performance, which are discussed in detail in section 2.2.2, with impacts on potentially impacted populations as described in section 2.2.1.

4.6.2 Job Creation

This measure would create more installation jobs for pipe insulation contractors.

5. Thermostatic Balancing Valves

5.1 Measure Description

5.1.1 Proposed Code Change

This proposal would add a new compliance option for projects that include thermostatic balancing valves (TBV) to balance multi-riser central DHW systems in multifamily buildings; the compliance credit would apply to systems that have a return pipe with a length less than 160 feet. The proposal would apply to new construction and to additions and alterations, and the same criteria applies in all cases. The proposal does not add or modify field verification or acceptance tests. The proposal requires a change to the compliance software. Title 24, Part 6 currently regulates the hot water recirculation system, but there are no specific requirements for balancing valves.

To receive the compliance credit the project must meet the following criteria:

1. Have more than one DHW supply riser
2. Each DHW supply riser shall have an accessible TBV.
 - a. Located after the last supply branch from the supply riser, in the direction of flow.
 - b. Set to a maximum temperature of 120 °F.
3. Variable speed hot water return circulating pumps installed to operate with differential pressure control.
4. For systems with one return pipe loop, hot water return piping that does not exceed 160 feet in length.
5. For systems with multiple recirculation return pipe loops, no return pipe may exceed 160 feet in length.

For additions and alterations, the compliance option would be most feasible when the scope of work includes replacement of the existing water heater, and/or addition of new plumbing fixtures that require hot water.

5.1.2 Justification and Background Information

5.1.2.1 Justification

This proposal would save energy while reducing first costs and installation time, improving delivery performance of the hot water distribution system and reducing callbacks. The proposal would also benefit water heater equipment efficiency due to lower return temperatures, although this energy benefit was not quantified for this report.

As described in Section 5.2.1, most multi-riser central DHW system designs include balancing valves. Based on plans review and interviews with stakeholders, The Statewide CASE Team concluded that manual balancing valves are still used in about half of projects. The prevalence of different manual balancing valve types was:

- Circuit setters, a type of manual balancing valve with a dial indicator and test pressure ports, were the most prevalent fully specified manual balancing valve product (5 of 16 plans reviewed).
- Flow limiting valves, which act as a manual balancing valve below a specified maximum flow rate and as a pressure independent control valve to limit flow from exceeding the design flow rate, were less prevalent (3 of 16 plans reviewed)
- Flow setter valves, a type of manual balancing valve with a digital flow indicator, were not specified (0 of 16 plans reviewed).

Several of the stakeholders the Statewide CASE Team interviewed switched to specifying or installing automatic balancing valves within the last five years. However, the Statewide CASE Team heard from one stakeholder that manual balancing valves are still common practice in new buildings, and many existing buildings do not have any balancing valves. Three of five stakeholders the Statewide CASE Team interviewed have switched to specifying or installing automatic balancing valves due in large part to the technical challenges associated with properly balancing manual balancing valves. Some of these challenges include that circuit setter valves require special instrumentation and labor-intensive balancing when the distribution system is first constructed. Often, these valves are poorly balanced or not balanced at all, resulting in poor distribution system performance and increased energy loss. Since the balancing process is iterative, even flow setter valves may not be properly balanced. The lack of manual balancing may result in occupant behavior that increases energy use, such as increasing the hot water supply set point temperature by up to 15 – 20 °F. To understand the impacts of poor or no manual balancing, the Statewide CASE Team performed lab testing of an unbalanced multi-riser distribution system with a nominal supply temperature of 130°F, and it observed that four of twelve risers never exceeded 90°F. The lab results corroborate stakeholder feedback that building owners often increase the supply temperature of poorly balanced systems by up to 20°F relative to well-balanced systems. The lab data and stakeholder feedback combined demonstrate a compelling argument that some existing buildings with no balancing valves would save significantly more energy than estimated by the Statewide CASE Teams energy modeling.

From the plans review the Statewide CASE Team performed, it found that engineers do not typically calculate the flow rate that is required to maintain a target minimum temperature in the hot water recirculation system, but rather specify an overly

conservative rule of thumb flow rate through each riser or fail to specify any flow rate. This results in recirculation system temperatures that are higher than necessary, and energy savings when automatic balancing valves are installed as opposed to manual balancing valves. The proposal would directly result in reduced hot water return temperatures and lower distribution system heat loss. This is the basis of the energy analysis presented in Section 5.3.1.

5.1.2.2 Background Information

This proposal adds a new compliance option to improve on current industry practice related to balancing of multi-riser systems, and it would increase adoption of automatic balancing valves in these systems. The proposal would save energy by lowering temperatures throughout the DHW distribution system as described in detail in Section 5.2.2. Current practice includes the use of manual balancing valves, automatic balancing valves, and flow limiting valves. These different product types are discussed in further detail in Section 5.2.2.

This proposal was previously investigated by the 2022 Statewide CASE Team, and it was not pursued because there were minimal energy savings due to the existing prescriptive circulation pump control (demand control) requirements.⁴¹ Although the 2022 Statewide CASE Team was not able to implement this measure, they were able to gather stakeholder feedback indicating that the prescriptive demand control requirements for central recirculation systems are not implemented in practice.

In October 2020, the Statewide CASE Team learned that the 2022 standard design in the compliance modeling software was updated in early 2020 to assume no demand control. Due to the change to the standard design, the 2025 Statewide CASE Team worked with the CEC to establish an appropriate baseline of no demand control and enable the calculation of energy savings for this measure.

The Statewide CASE Team is not aware of previous utility programs that specifically promote automatic balancing valves.

5.1.3 Summary of Proposed Changes to Code Documents

The sections below summarize how the standards, compliance manual, ACM reference manuals, and compliance forms would be modified by the proposed change.⁴² See Section 11 of this report for detailed proposed revisions to code language.

⁴¹ https://title24stakeholders.com/wp-content/uploads/2020/09/2022_T24_Final-CASE-Report-MF-DHW-Dist.pdf

⁴² Visit [EnergyCodeAce.com](https://www.energycodeace.com) for trainings, tools, and resources to help people understand existing code requirements.

5.1.3.1 Specific Purpose and Necessity of Proposed Code Changes

Section: 170.1(d)

Specific Purpose: The specific purpose is to update the existing performance requirements to add TBVs as an option.

Necessity: This addition is necessary to ensure TBVs perform properly when compliance credit is claimed; The code language refers to a reference appendix describing the requirements to claim compliance credit.

5.1.3.2 Specific Purpose and Necessity of Changes to the Nonresidential and Multifamily ACM Reference Manual

The purpose and necessity of proposed changes to the Nonresidential and Multifamily ACM Reference Manual are described below. See Section 11.4 of this report for the detailed proposed revisions to the text of the ACM Reference Manual.

Section: 6.11 DHW

Specific Purpose: One specific purpose is to update Section 6.11 to the ACM to add one multifamily central hot water heating central system type and modify an existing multifamily central hot water heating central system type to reflect the compliance option for TBV.

Another specific purpose is to update Appendix E: Water Heating Calculation Method to include modeling of TBV for multi-riser central system recirculating systems, including addition of an energy savings factor associated with TBV.

Necessity: These changes are necessary to explain how the compliance software would model the use of automatic balancing valves.

5.1.3.3 Summary of Changes to the Nonresidential and Multifamily Compliance Manual

Chapter 11, Section 11.6.1 would need to be modified to add a brief description of what is new. Chapter 11 section 11.6.7.7 Performance Approach of the Nonresidential and Multifamily Compliance Manual would need to be revised to add a subsection labelled “Thermostatic balancing valves with differential pressure variable speed pump control” that explains the compliance option including how it saves energy with an example and brief explanation of the length limitation. Table 11-55 in Chapter 11 would also be updated to document the assigned distribution system multiplier.

5.1.3.4 Summary of Changes to Compliance Forms

The proposed code change would modify the compliance forms listed below. Examples of the revised forms are presented in Section 11.5 of this report.

- **2022-LMCC-PLB-E: Domestic Water Heating:** Adds compliance option questions asking:
 - Are TBVs specified?
 - What is the number of supply riser pipes specified?
 - What is the number of return pipe loops specified?
 - What is the return piping length for each return pipe loop?
 - What is the TBV specified temperature set point?
 - Is the specified pump variable speed, and is the specified pump control method based on pump differential pressure control?
- **2022-NRCC-PLB-E: Domestic Water Heating:** Adds compliance option questions asking:
 - Are TBVs specified?
 - What is the number of supply riser pipes specified?
 - What is the number of return pipe loops specified?
 - What is the return piping length for each return pipe loop?
 - What is the TBV specified temperature set point?
 - Is the specified pump variable speed, and is the specified pump control method based on pump differential pressure control?
- **2022-LMCI-PLB-E: Domestic Water Heating:** Adds compliance option questions asking:
 - Are TBVs installed?
 - What is the number of installed supply riser pipes installed?
 - What is the number of installed return pipe loops installed?
 - Is the return piping length consistent with the design drawings?
 - If not, what is the return piping length for each return pipe loop?
 - What is the TBV installed temperature set point?
 - Is the specified pump variable speed, and is the pump control method based on pump differential pressure control?
- **2022-NRCI-PLB-E: Domestic Water Heating:** Adds compliance option questions asking:
 - Are TBVs installed?
 - What is the number of installed supply riser pipes installed?
 - What is the number of installed return pipe loops installed?
 - Is the return piping length consistent with the design drawings?
 - If not, what is the return piping length for each return pipe loop?

- What is the TBV installed temperature set point?
- Is the specified pump variable speed, and is the pump control method based on pump differential pressure control?

5.1.4 Regulatory Context

5.1.4.1 Determination of Inconsistency or Incompatibility with Existing State Laws and Regulations

This proposal is not relevant to other parts of the California Building Standards Code (<https://www.dgs.ca.gov/BSC/Codes>). Changes outside of Title 24, Part 6 are not needed.

There are no relevant state or local laws or regulations, and there is no conflict with the current CPC.

There are no other code change proposals under consideration for the 2025 code cycle that overlap with this proposal.

5.1.4.2 Duplication or Conflicts with Federal Laws and Regulations

There are no relevant federal laws or regulations.

5.1.4.3 Difference From Existing Model Codes and Industry Standards

During stakeholder interviews, the Statewide CASE Team identified ASHRAE Guideline 12 and ASHRAE Standard 188 as existing industry standards that overlap with the proposed code change. ASHRAE Guideline 12 provides information and guidance for control of legionellosis associated with building water systems, and there is overlap with the temperature set point required by the proposal. ASHRAE Standard 188 establishes minimum legionellosis risk management requirements for building water systems, and there is overlap with the balancing requirements of the proposed code change.

ASHRAE Guideline 12 states that hot water should be “consistently maintained at or above 120 °F throughout the hot-water system” including the hot water return system. The standard also states that “legionella growth slows, and they begin to die at water temperatures between 113 °F and 120 °F”. The guidance from ASHRAE Standard-12 was considered when developing the code requirement for maximum temperature set point at the automatic balancing valves.

ASHRAE Standard 188 requires that “all water systems shall be balanced, and a balance report for all water systems shall be provided to the building owner or designee.” This requirement supports the identification of a balanced system as a baseline, and there is no conflict with the proposal.

5.1.5 Compliance and Enforcement

When developing this proposal, the Statewide CASE Team considered methods to streamline the compliance and enforcement process and how negative impacts on market actors who are involved in the process could be mitigated or reduced. This section describes how to comply with the proposal. It also describes the compliance verification process. This section presents how the proposed changes could impact various market actors.

The compliance verification activities related to this measure that need to occur during each phase of the project are described below:

- **Design Phase:**
 - The plumbing engineer designs the buildings plumbing systems. Since manual balancing valves are standard practice, certain design aspects such as coordinating access to balancing valves are currently performed, and they are not considered new activities. To receive a compliance credit, the proposal would require the plumbing engineer to specify TBVs, design the DHW supply and return piping to meet the criteria outlined in the ACM, accurately determine the length of each return pipe loop, specify the circulation riser temperature set point and a variable speed circulation system pump with differential pressure control, and coordinate with the energy compliance professional to ensure compliance credit is received. The plumbing engineer would also need to coordinate with the plumbing subcontractor to ensure that the design length is achieved in the field.
 - The plumbing engineer would also coordinate with the energy consultant and contribute content for the applicable LMCC or NRCC compliance forms based on the project details.
- **Permit Application Phase:**
 - Plan checkers currently perform plan check reviews of the hot water distribution system and verify that the construction documents meet the requirements of current buildings codes. The proposal would add new activities to this phase, including requiring plan checkers to verify that the design team has met the criteria of designing around a TBV and variable speed pump to claim the compliance credit. The LMCC and NRCC forms would assist the plan checkers in verifying that new projects meet the requirements of the proposal.
- **Construction Phase:**
 - Plumbing subcontractors currently install the DHW system, including furnishing and installing the specified balancing valves and circulation pumps. One significant change associated with this proposal is that the

plumbing subcontractor would need to attest in the project compliance forms that the length of each return pipe loop as built does not exceed the calculated length specified in the construction documents. The plumbing subcontractor would also need to install a variable speed circulation pump and ensure the pump control is set appropriately as required for the project to receive compliance credit. The plumbing subcontractor would also need to install the TBVs, as the Statewide CASE Team heard from designers and contractors that TBVs are easier to properly install than manual balancing valves. Finally, the plumbing subcontractor would need to fill out the applicable LMCI or NRCI forms.

- **Inspection Phase:**

- The inspector typically reviews the applicable LMCI or NRCI forms and verifies that certain details of the distribution system comply with the building code. This proposal would add fields to the LMCI and NRCI forms and require the inspector to verify that the balancing valve and circulation pump products match the inputs in the applicable LMCI or NRCI form and that the temperature set point meets the proposed requirements.

The compliance process for automatic balancing valves would require new coordination activities between the plumbing engineer, the plumbing subcontractor, and the energy compliance professional in the design and construction phases. The proposal would also result in new plan check and inspection activities. Compliance forms can be used to reduce the burden on the plan checker and inspector, while ensuring the proposal is properly enforced.

5.2 Market Analysis

5.2.1 Current Market Structure

The Statewide CASE Team performed a market analysis with the goals of identifying current technology availability, current product availability, and market trends. It then considered how the proposed standard may impact the market in general as well as individual market actors. Information was gathered about the incremental cost of complying with the proposed measure. Estimates of market size and measure applicability were identified through research and outreach with stakeholders including design consultants, designers, contractors, and manufacturer’s representatives. In addition to conducting personalized outreach, the Statewide CASE Team discussed the current market structure and potential market barriers during a public stakeholder meeting that the Statewide CASE Team held on February 17, 2023.

The Statewide CASE Team interviewed three designers, one design consultant, one plumbing contractor, and one general contractor to understand the current market. The Statewide CASE Team also reviewed 16 plans from real world projects.

The plumbing engineer is responsible for the design and performance of the hot water distribution system and specification of the circulation pump. The Statewide CASE Team found via plans review that the plumbing engineer typically, but not always, specifies balancing valves in the building plans. In 3 of 16 plans reviewed, the engineer referred to the balancing valve generically as “balancing valve(s)” in schematic riser diagrams and in the drawing legend, but they did not fully specify the balancing valve product. Furthermore, 1 of 16 plans reviewed did not include any reference to a balancing valve. The absence of product specification could result in no balancing valves being installed, and at best, it leaves room for interpretation of what balancing valves are required to meet the engineers design intent.

The plumbing subcontractor is responsible for furnishing piping and products required for the installation of the DHW system and for installation and startup of the DHW system. The plumbing subcontractor’s responsibilities cover all components required to meet this proposal, and the Statewide CASE Team found that the plumbing subcontractor is responsible for valve balancing and pump setup.

5.2.2 Technical Feasibility and Market Availability

The Statewide CASE Team developed the proposal to be technically feasible and established that the proposal is technically feasible by reviewing existing literature, interviewing plumbing designers, plumbing design consultants, and plumbing contractors, and through review of 16 multifamily building plans. The Statewide CASE Team also performed calculations and preliminary lab testing to understand how TBV performance scales with the size of the DHW distribution system. Appendix R: Building Level Electric Readiness Cleanup describes this preliminary lab testing in detail, and more lab testing is planned to further understand how TBV perform.

The final proposal is based on products that are readily available on the market and limited to applications where there is sufficient evidence to support the claimed energy savings. To highlight how the Statewide CASE Team incorporated this evidence, the proposal is now a compliance option for TBV in smaller buildings whereas the original plan was to propose a prescriptive requirement for TBVs in all buildings with an alternative requirement for PICV valves for certain applications with at-risk populations. The Statewide CASE Team also identified several research gaps that should be addressed to support future code improvements on the topic of DHW system balancing in multifamily buildings.

The Statewide CASE Team identified potential market barriers that could negatively impact implementation of the proposal. The most significant market barriers include

concerns around legionella control and balancing valve product limitations that could negatively affect performance. The Statewide CASE Team altered the proposal to address these market barriers.

The Statewide CASE Team interviewed several engineers and design consultants who spoke to the importance of legionella control, which is achieved in large part by maintaining an adequately high temperature in the distribution system. There was no consensus on an exact temperature requirement to maintain adequate legionella control, and the stakeholders cited different values for return temperatures ranging from 110°F to 122°F. To address the concern of legionella control, the Statewide CASE Team chose a maximum set point value of 120°F for the proposed compliance code language; this is a lower set point than some of the stakeholders the Statewide CASE Team specify, but it is towards the high end of the range, and it does not conflict with ASHRAE Guideline 12 (see Section 5.1.4.3: Difference From Existing Model Codes and Industry Standards), assuming there is minimal temperature drop in the return piping. Because the proposal is for a compliance option, any designers who are concerned that 120 °F set point is not adequate for legionella control can choose not to claim the compliance credit.

Two stakeholders the Statewide CASE Team interviewed stated clearly that they do not use TBV in larger DHW distribution systems, because the valves nearest the water heating plant cannot limit flow adequately in practice to achieve set point. Both stakeholders recommended that PICV are more appropriate for large DHW distribution systems. Based on these concerns, the Statewide CASE Team investigated the manufacturers rated minimum and maximum Cv values of six TBV products and incorporated valve hydraulic performance of a representative TBV into the energy modeling. The Statewide CASE Team also performed preliminary lab testing at the PG&E Applied Technology Services (ATS) distribution lab, as described in Appendix R, to verify the calculations. Based on the results of this work, the Statewide CASE Team found that pressure drop in the return pipe affects the energy savings of the TBV. The Statewide CASE Team considered two criteria that could be used to limit the compliance credit to systems with similar or lower return pipe pressure drops as the lab test. The two possible criteria were length, and developed length plus equivalent fitting length which would be more technically accurate and is established in Appendix A104.4 of the CPC for sizing the water supply system. The Statewide CASE Team decided to establish a length criterion since requiring designers to calculate developed length plus equivalent fitting length would be onerous for the value of the compliance credit, plus it is unlikely that the designer would then also review shop or as-built drawings to verify the accuracy of that calculation against what is installed. The length criterion established in the proposal is equal to the length of the hot water return piping in the lab test. Ultimately, the proposal is conservative, and the Statewide CASE Team recommends future work to understand the impacts of TBV hydraulic performance on field performance. For instance, even if a given TBV cannot meet the set point, there

may still be significant energy savings potential as compared to a system with manual balancing valves that is not balanced correctly.

A third market barrier is that the proposal includes a maximum developed length for each return pipe loop, above which the project is not eligible for a compliance credit. This would require plumbing engineers to calculate a return piping developed length for each return pipe loop, and importantly, it would require the plumbing subcontractor to install piping in such a way that the maximum developed length is not exceeded. Possible methods for compliance with the developed length criteria are discussed in detail in Section 5.1.5, but ultimately, some project teams may decide against using the compliance option because of this requirement.

The Statewide CASE Team determined market availability through stakeholder engagement and through plans review and research of products that are specified in new projects in California. The Statewide CASE Team determined that TBV and variable speed pumps are currently available on the market and in use. For instance, TBV were specified in 4 of 16 plans reviewed, and 3 of 7 stakeholders interviewed use TBVs in some of their projects. Furthermore, the Statewide CASE Team found products from at least 5 manufacturers of TBV that are available within the state. Variable speed pumps were specified in 7 of 16 plans reviewed.

Other products that the Statewide CASE Team considered were PICV and digital balancing valves. PICV products for DHW applications do exist, but they require more intensive design than TBV to implement correctly and are used by sophisticated designers. PICV were in 0 of 16 plans reviewed. The Statewide CASE Team also heard from one stakeholder that digital automatic balancing valve products are available internationally, but not yet in the U.S. PICV and digital automatic balancing valves should be considered for future energy code improvements, but they were not incorporated as part of this proposal.

In addition to addressing possible technical barriers, the Statewide CASE Team learned of several benefits associated with using TBV paired with variable speed circulation pumps as opposed to current practice. Because these products adapt to meet temperature and differential pressure set points, the system is more capable of maintaining balance against changes in pipe and fixture layout, changes in piping hydraulic characteristics due to water hardness, or sediment fouling in fixtures, which contributes to an expected high persistence of savings. Furthermore, the Statewide CASE Team heard of positive impacts on hot water delivery, resulting in less wasted water and greater occupant comfort.

5.2.3 Market Impacts and Economic Assessments

5.2.3.1 Impact on Builders

Builders of residential and commercial structures are directly impacted by many of the measures proposed by the Statewide CASE Team for the 2025 code cycle. It is within the normal practices of these businesses to adjust their building practices to changes in building codes. When necessary, builders engage in continuing education and training in order to remain compliant with changes to design practices and building codes.

California’s construction industry comprises approximately 93,000 business establishments and 943,000 employees (see Section 5.2.1). For 2022, total estimated payroll would be about \$78 billion. Nearly 72,000 of these business establishments and 473,000 employees are engaged in the residential building sector, while another 17,600 establishments and 369,000 employees focus on the commercial sector. The remainder of establishments and employees work in industrial, utilities, infrastructure, and other heavy construction roles (the industrial sector).

Table 106: California Construction Industry, Establishments, Employment, and Payroll in 2022 (Estimated)

Building Type	Construction Sectors	Establishments	Employment	Annual Payroll (Billions \$)
Residential	All	71,889	472,974	31.2
Residential	Building Construction Contractors	27,948	130,580	9.8
Residential	Foundation, Structure, & Building Exterior	7,891	83,575	5.0
Residential	Building Equipment Contractors	18,108	125,559	8.5
Residential	Building Finishing Contractors	17,942	133,260	8.0
Commercial	All	17,621	368,810	35.0
Commercial	Building Construction Contractors	4,919	83,028	9.0
Commercial	Foundation, Structure, & Building Exterior	2,194	59,110	5.0
Commercial	Building Equipment Contractors	6,039	139,442	13.5
Commercial	Building Finishing Contractors	4,469	87,230	7.4
Industrial, Utilities, Infrastructure, & Other (Industrial+)	All	4,206	101,002	11.4
Industrial+	Building Construction	288	3,995	0.4
Industrial+	Utility System Construction	1,761	50,126	5.5
Industrial+	Land Subdivision	907	6,550	1.0
Industrial+	Highway, Street, and Bridge Construction	799	28,726	3.1
Industrial+	Other Heavy Construction	451	11,605	1.4

Source: (State of California n.d.)

The proposed change to automatic balancing valves would likely affect residential builders but would not impact firms that focus on construction and retrofit of industrial buildings, utility systems, public infrastructure, or other heavy construction. The effects on the residential and commercial building industry would not be felt by all firms and workers, but rather would be concentrated in specific industry subsectors. Table 107 shows the residential building subsectors the Statewide CASE Team expects to be impacted by the changes proposed in this report. The installation of automatic balancing valves would require less labor to install. Variable speed pumps would require additional set up time to program the pump correctly. The Statewide CASE Team’s estimates of the magnitude of these impacts are shown in Section 5.2.4.

Table 107: Specific Subsectors of the California Residential Building Industry by Subsector in 2022 (Estimated)

Residential Building Subsector	Establishments	Employment	Annual Payroll (Billions \$)
New multifamily general contractors	421	6,344	0.7
New housing for-sale builders	189	3,969	0.5
Residential plumbing and HVAC contractors	9,852	75,404	5.1

Source: (State of California n.d.)

5.2.3.2 Impact on Building Designers and Energy Consultants

Adjusting design practices to comply with changing building codes is within the normal practices of building designers. Building codes (including Title 24, Part 6) are typically updated on a three-year revision cycle and building designers and energy consultants engage in continuing education and training to remain compliant with changes to design practices and building codes.

Until now, it has been common practice for designers to specify manual balancing valves in multifamily DHW recirculation risers. Consistently specifying TBVs for these risers would require some education of the plumbing engineering community regarding the energy savings potential that can be realized from such a small change in design practice. Manufacturers as well as professional associations would be optimum vessels of education for this measure.

Businesses that focus on residential, commercial, institutional, and industrial building design are contained within the Architectural Services sector (NAICS 541310). Table 108 shows the number of establishments, employment, and total annual payroll for Building Architectural Services. The proposed code changes would potentially impact all firms within the Architectural Services sector. The Statewide CASE Team anticipates the impacts for automatic balancing valves to affect firms that focus on multifamily construction.

There is not a NAICS⁴³ code specific to energy consultants. Instead, businesses that focus on consulting related to building energy efficiency are contained in the Building Inspection Services sector (NAICS 541350), which is comprised of firms primarily engaged in the physical inspection of residential and nonresidential buildings.⁴⁴ It is not possible to determine which business establishments within the Building Inspection Services sector are focused on energy efficiency consulting. The information shown in Table 108 provides an upper bound indication of the size of this sector in California.

Table 108: California Building Designer and Energy Consultant Sectors in 2022 (Estimated)

Sector	Establishments	Employment	Annual Payroll (Millions \$)
Architectural Services^a	4,134	31,478	3,623.3
Building Inspection Services^b	1,035	3,567	280.7

Source: (State of California n.d.)

- a. Architectural Services (NAICS 541310) comprises private-sector establishments primarily engaged in planning and designing residential, institutional, leisure, commercial, and industrial buildings and structures.
- b. Building Inspection Services (NAICS 541350) comprises private-sector establishments primarily engaged in providing building (residential & nonresidential) inspection services encompassing all aspects of the building structure and component systems, including energy efficiency inspection services.

5.2.3.3 Impact on Occupational Safety and Health

The proposed code change does not alter any existing federal, state, or local regulations pertaining to safety and health, including rules enforced by the California DOSH. All existing health and safety rules would remain in place. Complying with the proposed code change is not anticipated to have adverse impacts on the safety or health of occupants or those involved with the construction, commissioning, and maintenance of the building.

⁴³ NAICS is the standard used by federal statistical agencies in classifying business establishments for the purpose of collecting, analyzing, and publishing statistical data related to the U.S. business economy. NAICS was developed jointly by the U.S. Economic Classification Policy Committee (ECPC), Statistics Canada, and Mexico's Instituto Nacional de Estadística y Geografía, to allow for a high level of comparability in business statistics among the North American countries. NAICS replaced the Standard Industrial Classification (SIC) system in 1997.

⁴⁴ Establishments in this sector include businesses primarily engaged in evaluating a building's structure and component systems and includes energy efficiency inspection services and home inspection services. This sector does not include establishments primarily engaged in providing inspections for pests, hazardous wastes or other environmental contaminants, nor does it include state and local government entities that focus on building or energy code compliance/enforcement of building codes and regulations.

5.2.3.4 Impact on Building Owners and Occupants Including Homeowners and Potential First-Time Homeowners)

Residential Buildings

According to data from the U.S. Census ACS, there were more than 14.5 million housing units in California in 2021 and nearly 13.3 million were occupied (see Table 109). Most housing units (nearly 9.42 million) were single family homes (either detached or attached), approximately 2 million homes were in buildings containing two to nine units, and 2.5 million homes were in multifamily buildings containing 10 or more units. The California Department of Revenue estimated that building permits for 67,300 single family and 54,900 multifamily homes would be issued in 2022, up from 66,000 single family and 53,500 multifamily permits issued in 2021.

Table 109: California Housing Characteristics in 2021^a

Housing Measure	Estimate
Total housing units	14,512,281
Occupied housing units	13,291,541
Vacant housing units	1,220,740
Homeowner vacancy rate	0.7%
Rental vacancy rate	4.3%
Number of 1-unit, detached structures	8,388,099
Number of 1-unit, attached structures	1,030,372
Number of 2-unit structures	348,295
Number of 3- or 4-unit structures	783,663
Number of 5- to 9-unit structures	856,225
Number of 10- to 19-unit structures	740,126
Number of 20+ unit structures	1,828,547
Mobile home, RV, etc.	522,442

Sources: (United States Census Bureau n.d.), (Federal Reserve Economic Data (FRED) n.d.)

a. Total housing units as reported for 2021; all other housing measures estimated based on historical relationships.

Table 110 shows the distribution of California homes by vintage. About 15 percent of California homes were built in 2000 or later and another 11 percent built between 1990 and 1999. The majority of California’s existing housing stock (8.5 million homes – 59 percent of the total) were built between 1950 and 1989, a period of rapid population and economic growth in California. Finally, about 2.1 million homes in California were built before 1950. According to Kenney et al, 2019, more than half of California’s existing multifamily buildings (those with five or more units) were constructed before 1978 when there were no building energy efficiency standards (Kenney 2019).

Table 110: Distribution of California Housing by Vintage in 2021 (Estimated)

Home Vintage	Units	Percent	Cumulative Percent
Built 2014 or later	348,296	2.4	2.4
Built 2010 to 2013	261,221	1.8	4.2
Built 2000 to 2009	1,581,839	10.9	15.1
Built 1990 to 1999	1,596,351	11.0	26.1
Built 1980 to 1989	2,191,354	15.1	41.2
Built 1970 to 1979	2,539,649	17.5	58.7
Built 1960 to 1969	1,915,621	13.2	71.9
Built 1950 to 1959	1,930,133	13.3	85.2
Built 1940 to 1949	841,712	5.8	91.0
Built 1939 or earlier	1,306,105	9.0	100.0
Total housing units	14,512,281	100.0	—

Sources: (United States Census Bureau n.d.), (Federal Reserve Economic Data (FRED) n.d.)

Table 111 shows the distribution of owner- and renter-occupied housing by household income. Overall, about 55 percent of California housing is owner-occupied and the rate of owner-occupancy generally increases with household income. The owner-occupancy rate for households with an income below \$50,000 is only 37 percent, whereas the owner occupancy rate is 71 percent for households earning \$100,000 or more.

Table 111: Owner- and Renter-Occupied Housing Units in California by Income in 2021 (Estimated)

Household Income	Total	Owner Occupied	Renter Occupied
Less than \$5,000	353,493	113,315	240,178
\$5,000 to \$9,999	254,304	74,939	179,366
\$10,000 to \$14,999	495,287	134,633	360,654
\$15,000 to \$19,999	412,498	144,064	268,435
\$20,000 to \$24,999	467,694	169,431	298,264
\$25,000 to \$34,999	906,996	355,968	551,028
\$35,000 to \$49,999	1,319,892	560,453	759,438
\$50,000 to \$74,999	2,036,560	990,769	1,045,791
\$75,000 to \$99,999	1,662,032	920,607	741,425
\$100,000 to \$149,999	2,307,889	1,490,247	817,642
\$150,000 or more	3,074,895	2,337,651	737,244
Total Housing Units	13,291,541	7,292,076	5,999,465

Source: (United States Census Bureau n.d.), (Federal Reserve Economic Data (FRED) n.d.)

Understanding the distribution of California residents by home type, home vintage, and household income is critical for developing meaningful estimates of the economic

impacts associated with proposed code changes affecting residents. Many proposed code changes specifically target single family or multifamily residences and so the counts of housing units by building type shown in Table 111 provides the information necessary to quantify the magnitude of potential impacts. Likewise, impacts may differ for owners and renters, by home vintage, and by household income, information provided in Table 109 and Table 110.

Estimating Impacts

For California residents, the proposed code changes would result in lower energy bills. The Statewide CASE Team estimates that on average the proposed change to Title 24, Part 6 would decrease construction cost by about \$9 per multifamily dwelling unit, and the measure would also result in a savings of \$138 in energy and maintenance cost savings over 30 years. This is roughly equivalent to a \$0.04 per month decrease in payments for a 30-year mortgage and a \$0.38 per month reduction in energy costs. Overall, the Statewide CASE Team expects the 2025 Title 24, Part 6 Standards to save homeowners about \$5 per year relative to homeowners whose dwelling units are minimally compliant with the 2022 Title 24, Part 6 requirements. As discussed in Section 5.2.4.1, when homeowners or building occupants save on energy bills, they tend to spend it elsewhere thereby creating jobs and economic growth for the California economy. Energy cost savings can be particularly beneficial to low-income homeowners who typically spend a higher portion of their income on energy bills, often have trouble paying energy bills, and sometimes go without other necessities to save money for energy bills (Association, National Energy Assistance Directors 2011).

5.2.3.5 Impact on Building Component Retailers (Including Manufacturers and Distributors)

The Statewide CASE Team anticipates the proposed change would have a modest impact on retailers. Balancing valves and pumps are currently standard practice for DHW systems with recirculation. This measure would simply result in retailers stocking more of the slightly more expensive TBVs they already keep in their warehouses. The measure is expected to result in increased use of slightly smaller circulation pumps that have slightly more sophisticated controls than the baseline pumps, so the Statewide CASE Team anticipates a similar minimal impact on retailers.

5.2.3.6 Impact on Building Inspectors

Table 112 shows employment and payroll information for state and local government agencies in which many inspectors of residential and commercial buildings are employed. Building inspectors participate in continuing education and training to stay current on all aspects of building regulations, including energy efficiency. Therefore, the Statewide CASE Team anticipates the proposed change would have no impact on

employment of building inspectors or the scope of their role conducting energy efficiency inspections.

Table 112: Employment in California State and Government Agencies with Building Inspectors in 2022 (Estimated)

Sector	Govt.	Establishments	Employment	Annual Payroll (Million \$)
Administration of Housing Programs ^a	State	18	265	29.0
	Local	38	3,060	248.6
Urban and Rural Development Admin ^b	State	38	764	71.3
	Local	52	2,481	211.5

Source: (State of California, Employment Development Department n.d.)

- a. Administration of Housing Programs (NAICS 925110) comprises government establishments primarily engaged in the administration and planning of housing programs, including building codes and standards, housing authorities, and housing programs, planning, and development.
- b. Urban and Rural Development Administration (NAICS 925120) comprises government establishments primarily engaged in the administration and planning of the development of urban and rural areas. Included in this industry are government zoning boards and commissions.

5.2.3.7 Impact on Statewide Employment

As described in Sections 5.2.3.1 through 5.2.3.6, the Statewide CASE Team does not anticipate significant employment or financial impacts to any sector of the California economy. This is not to say that the proposed change would not have modest impacts on employment in California. In Section 5.2.4.1, the Statewide CASE Team estimated the proposed change in balancing valves and variable speed pumps would affect statewide employment and economic output directly and indirectly through its impact on builders, designers and energy consultants, and building inspectors. In addition, the Statewide CASE Team estimated how energy savings associated with the proposed change in balancing valves and variable speed pumps would lead to modest ongoing financial savings for California residents, which would then be available for other economic activities.

5.2.4 Economic Impacts

For the 2025 code cycle, the Statewide CASE Team used the IMPLAN model software,⁴⁵ along with economic information from published sources and professional judgement to develop estimates of the economic impacts associated with each of the proposed code changes. Conceptually, IMPLAN estimates jobs created as a function of incoming cash flow in different sectors of the economy, due to implementing a code or a

⁴⁵ IMPLAN employs economic data and advanced economic impact modeling to estimate economic impacts for interventions like changes to the California Title 24, Part 6 code. For more information on the IMPLAN modeling process, see www.IMPLAN.com.

standard. The jobs created are typically categorized into direct, indirect, and induced employment. For example, cash flow into a manufacturing plant captures direct employment (jobs created in the manufacturing plant), indirect employment (jobs created in the sectors that provide raw materials to the manufacturing plant) and induced employment (jobs created in the larger economy due to purchasing habits of people newly employed in the manufacturing plant). Eventually, IMPLAN computes the total number of jobs created due to a code. The assumptions of IMPLAN include constant returns to scale, fixed input structure, industry homogeneity, no supply constraints, fixed technology, and constant byproduct coefficients. The model is also static in nature and is a simplification of how jobs are created in the macro-economy.

The economic impacts developed for this report are only estimates and are based on limited and to some extent speculative information. The IMPLAN model provides a relatively simple representation of the California economy and, though the Statewide CASE Team is confident that the direction and approximate magnitude of the estimated economic impacts are reasonable, it is important to understand that the IMPLAN model is a simplification of extremely complex actions and interactions of individual, businesses, and other organizations as they respond to changes in energy efficiency codes. In all aspects of this economic analysis, the CASE Authors rely on conservative assumptions regarding the likely economic benefits associated with the proposed code change. By following this approach, the economic impacts presented below represent lower bound estimates of the actual benefits associated with this proposed code change.

Adoption of this code change proposal would result in relatively modest economic impacts through the additional direct spending by those in the residential building and remodeling industry as well as indirectly as residents spend all or some of the money saved through lower utility bills on other economic activities.⁴⁶ There may also be some nonresidential customers that are impacted by this proposed code change; however, the Statewide CASE Team does not anticipate such impacts to be materially important to the building owner and would have measurable economic impacts.

Table 113: Estimated Impact that Adoption of the Proposed Measure would have on the California Residential Construction Sector

Type of Economic Impact	Employment (Jobs)	Labor Income	Total Value Added	Output
Direct Effects (Additional spending by Residential Builders)	-3.9	(\$309,703)	\$148,542	\$181,152
Indirect Effect (Additional spending by firms supporting Residential Builders)	0.2	\$12,813	\$20,869	\$35,989

⁴⁶ For example, for the lowest income group, the Statewide CASE Team assumes 100 percent of money saved through lower energy bills would be spent, while for the highest income group, the Statewide CASE Team assumes only 64 percent of additional income would be spent.

Induced Effect (Spending by employees of firms experiencing “direct” or “indirect” effects)	-1.5	(\$99,159)	(\$177,529)	(\$282,559)
Total Economic Impacts	-5.2	(\$396,049)	(\$8,119)	(\$65,418)

Source: Statewide CASE Team analysis of data from the IMPLAN modeling software.⁴⁷

Table 114: Estimated Impact that Adoption of the Proposed Measure would have on the California Residential Remodel Sector

Type of Economic Impact	Employment (Jobs)	Labor Income	Total Value Added	Output
Direct Effects (Additional spending by Residential Builders)	0.6	\$42,639	\$64,895	\$139,231
Indirect Effect (Additional spending by firms supporting Residential Builders)	0.3	\$25,553	\$43,664	\$74,180
Induced Effect (Spending by employees of firms experiencing “direct” or “indirect” effects)	0.3	\$19,617	\$35,124	\$55,905
Total Economic Impacts	1.2	\$87,809	\$143,683	\$269,316

Source: Statewide CASE Team analysis of data from the IMPLAN modeling software.⁴⁸

Table 115: Estimated Impact that Adoption of the Proposed Measure would have on the California Building Designers and Energy Consultants

Type of Economic Impact	Employment (Jobs)	Labor Income	Total Value Added	Output
Direct Effects (Additional spending by Building Designers & Energy Consultants)	0.09	\$10,267	\$10,164	\$16,065
Indirect Effect (Additional spending by firms supporting Bldg. Designers & Energy Consultants)	0.04	\$3,057	\$4,249	\$6,839
Induced Effect (Spending by employees of firms experiencing “direct” or “indirect” effects)	0.06	\$3,831	\$6,861	\$10,920
Total Economic Impacts	0.19	\$17,155	\$21,273	\$33,824

Source: Statewide CASE Team analysis of data from the IMPLAN modeling software.

⁴⁷ IMPLAN® model, 2020 Data, IMPLAN Group LLC, IMPLAN System (data and software), 16905 Northcross Dr., Suite 120, Huntersville, NC 28078 www.IMPLAN.com

⁴⁸ IMPLAN® model, 2020 Data, IMPLAN Group LLC, IMPLAN System (data and software), 16905 Northcross Dr., Suite 120, Huntersville, NC 28078 www.IMPLAN.com

Table 116: Estimated Impact that Adoption of the Proposed Measure would have on California Building Inspectors

Type of Economic Impact	Employment (Jobs)	Labor Income	Total Value Added	Output
Direct Effects (Additional spending by Building Inspectors)	0.05	\$5,180	\$6,142	\$7,464
Indirect Effect (Additional spending by firms supporting Building Inspectors)	0.01	\$480	\$747	\$1,301
Induced Effect (Spending by employees of Building Inspection Bureaus and Departments)	0.02	\$1,629	\$2,918	\$4,645
Total Economic Impacts	0.08	\$7,288	\$9,808	\$13,410

Source: Statewide CASE Team analysis of data from the IMPLAN modeling software.

Table 117: Estimated Impact that Adoption of the Proposed Measure would have on Discretionary Spending by California Residents

Type of Economic Impact	Employment (Jobs)	Labor Income	Total Value Added	Output
Direct Effects (Additional spending by households)	0.0	\$0	\$0	\$0
Indirect Effect (Purchases by businesses to meet additional household spending)	0.0	\$0	\$0	\$0
Induced Effect (Spending by employees of businesses experiencing “indirect” effects)	0.0	(\$306)	(\$553)	(\$879)
Total Effect	0.0	(\$306)	(\$553)	(\$879)

Source: Statewide CASE Team analysis of data from the IMPLAN modeling software.

5.2.4.1 Creation or Elimination of Jobs

The Statewide CASE Team does not anticipate that the measures proposed for the 2025 code cycle regulation would lead to the creation of new *types* of jobs or the elimination of *existing* types of jobs. In other words, the Statewide CASE Team’s proposed change would not result in economic disruption to any sector of the California economy. Rather, the estimates of economic impacts discussed in Section 5.2.4 would lead to modest changes in employment of existing jobs.

5.2.4.2 Creation or Elimination of Businesses in California

As stated in Section 5.2.4, the Statewide CASE Team’s proposed change would not result in economic disruption to any sector of the California economy. The proposed change represents a modest change to the installation of automatic balancing valves and variable speed pumps which would not excessively burden or competitively disadvantage California businesses—nor would it necessarily lead to a competitive advantage for California businesses. Therefore, the Statewide CASE Team does not

foresee any new businesses being created, nor does the Statewide CASE Team think any existing businesses would be eliminated due to the proposed code changes.

5.2.4.3 *Competitive Advantages or Disadvantages for Businesses in California*

The proposed code changes would apply to all businesses incorporated in California, regardless of whether the business is located inside or outside of the state.⁴⁹ Therefore, the Statewide CASE Team does not anticipate that these measures proposed for the 2025 code cycle regulation would have an adverse effect on the competitiveness of California businesses. Likewise, the Statewide CASE Team does not anticipate businesses located outside of California would be advantaged or disadvantaged.

5.2.4.4 *Increase or Decrease of Investments in the State of California*

The Statewide CASE Team analyzed national data on corporate profits and capital investment by businesses that expand a firm’s capital stock (referred to as net private domestic investment, or NPDI).⁵⁰ As Table 118 shows, between 2017 and 2021, NPDI as a percentage of corporate profits ranged from a low of 18 in 2020 due to the worldwide economic slowdowns associated with the COVID 19 pandemic to a high of 35 percent in 2019, with an average of 26 percent. While only an approximation of the proportion of business income used for net capital investment, the Statewide CASE Team believes it provides a reasonable estimate of the proportion of proprietor income that would be reinvested by business owners into expanding their capital stock.

Table 118: Net Domestic Private Investment and Corporate Profits, U.S.

Year	Net Domestic Private Investment by Businesses, Billions of Dollars	Corporate Profits After Taxes, Billions of Dollars	Ratio of Net Private Investment to Corporate Profits (Percent)
2017	518.473	1882.460	28
2018	636.846	1977.478	32
2019	690.865	1952.432	35
2020	343.620	1908.433	18
2021	506.331	2619.977	19
5-Year Average	-	-	26

Source: (Federal Reserve Economic Data (FRED) n.d.)

⁴⁹ Gov. Code, §§ 11346.3(c)(1)(C), 11346.3(a)(2); 1 CCR § 2003(a)(3) Competitive advantages or disadvantages for California businesses currently doing business in the state.

⁵⁰ Net private domestic investment is the total amount of investment in capital by the business sector that is used to expand the capital stock, rather than maintain or replace due to depreciation. Corporate profit is the money left after a corporation pays its expenses.

The Statewide CASE Team does not anticipate that the economic impacts associated with the proposed measure would lead to significant change (increase or decrease) in investment, directly or indirectly, in any affected sectors of California's economy. Nevertheless, the Statewide CASE Team can derive a reasonable estimate of the change in investment by California businesses based on the estimated change in economic activity associated with the proposed measure and its expected effect on proprietor income, which the Statewide CASE Team uses a conservative estimate of corporate profits, a portion of which the Statewide CASE Team assumes would be allocated to net business investment.⁵¹

5.2.4.5 Incentives for Innovation in Products, Materials, or Processes

The requirement for automatic balancing valves would incentivize innovation by signaling to manufacturers that there is an increasing understanding of the value of properly balanced DHW distribution systems. There is no negative incentive on innovation and the Statewide CASE Team chose to propose a compliance option in part to minimize any possible unforeseen negative impacts of the proposal on innovation. Furthermore, based on stakeholder input, TBVs are already the most likely automatic balancing valve to be used in buildings with shorter recirculation return pipes and the proposal does not incentivize or dis-incentivize certain product types for distribution systems with longer recirculation return pipes. Therefore, there is no negative impact on innovation of PICV, digital, and other emerging balancing valve types.

The requirement for variable speed pumps with differential pressure control does not have any impact on innovation, as this is already a commonly available product and the variable speed capability and method of control only add functionality. Circulation pumps are capable of being manufactured with multiple pre-configured control settings and capabilities.

5.2.4.6 Effects on the State General Fund, State Special Funds, and Local Governments

The Statewide CASE Team does not expect the proposed code changes would have a measurable impact on California's General Fund, any state special funds, or local government funds.

Cost of Enforcement

Cost to the State: State government already has budget for code development, education, and compliance enforcement. While state government would be allocating resources to update the Title 24, Part 6 Standards, including updating education and compliance materials and responding to questions about the revised requirements,

⁵¹ 26 percent of proprietor income was assumed to be allocated to net business investment; see Table 118.

these activities are already covered by existing state budgets. The costs to state government are small when compared to the overall costs savings and policy benefits associated with the code change proposals. The Statewide CASE Team does not anticipate this measure to affect state buildings.

Cost to Local Governments: All proposed code changes to Title 24, Part 6 would result in changes to compliance determinations. Local governments would need to train building department staff on the revised Title 24, Part 6 Standards. While this re-training is an expense to local governments, it is not a new cost associated with the 2025 code change cycle. The building code is updated on a triennial basis, and local governments plan and budget for retraining every time the code is updated. There are numerous resources available to local governments to support compliance training that can help mitigate the cost of retraining, including tools, training and resources provided by the IOU Codes and Standards program (such as Energy Code Ace). As noted in Section 5.1.5 and Appendix E, the Statewide CASE Team considered how the proposed code change might impact various market actors involved in the compliance and enforcement process and aimed to minimize negative impacts on local governments.

5.2.4.7 Impacts on Specific Persons

While the objective of any of the Statewide CASE Team's proposal is to promote energy efficiency, the Statewide CASE Team recognizes that there is the potential that a proposed code change may result in unintended consequences. Refer to Section 5.6 for more details addressing energy equity and environmental justice.

5.2.5 Fiscal Impacts

5.2.5.1 Mandates on Local Agencies or School Districts

There are no relevant mandates to school districts, because this only impacts multifamily buildings. There are also no mandates for local agencies because the requirements would be specified at the statewide level through Title 24, Part 6.

5.2.5.2 Costs to Local Agencies or School Districts

There are no costs to school districts, because this only impacts multifamily buildings. For local agencies the Statewide CASE Team does not anticipate any increase in work for building inspectors.

5.2.5.3 Costs or Savings to Any State Agency

There are no costs or savings to state agencies because they would not be involved in enforcement of the measure.

5.2.5.4 Other Non-Discretionary Cost or Savings Imposed on Local Agencies

There are no added non-discretionary costs or savings to local agencies.

5.2.5.5 Costs or Savings in Federal Funding to the State

There are no costs or savings to federal funding to the state due to the measure. The proposed measure is a relatively small cost which the market would bear. The state would not require federal funding to implement the proposed measure.

5.3 Energy Savings

5.3.1 Energy Savings Methodology

The Statewide CASE Team used a recirculation heat loss spreadsheet calculator (see Appendix H for details) to assess the energy impact of the proposed code change. This spreadsheet calculator used pipe heat loss calculation methods defined in the existing 2022 ACM Reference Manual. The spreadsheet calculator includes features to handle detailed recirculation piping designs, insulation conditions, and recirculation flow controls. In comparison, CBECC uses a simple recirculation model with six pipe sections to streamline code compliance, but CBECC is not capable of assessing the actual energy impact of recirculation system designs found in real buildings. This calculator was also used to support energy impact analysis during the 2022 Code Cycle for multifamily DHW distribution measures. Based on the output of the recirculation heat loss calculator, the Statewide CASE Team calculated site, source, and LSC savings as described in following sections.

The proposed balancing valve requirements have limited impact on water heating plant operation. Therefore, water heating plant pipe heat loss was not included in energy savings analysis for this proposed code change.

5.3.1.1 Key Assumptions for Energy Savings Analysis

The CEC directed the Statewide CASE Team to assess the energy impacts of proposed code changes for four prototypical multifamily buildings as described in Section 5.3.1.2. Detailed recirculation system piping configurations for the four prototypical buildings were developed during the 2022 Code Cycle (see Appendix I) and were incorporated into the recirculation heat loss spreadsheet calculator to assess distribution heat loss. Table 119 provides key assumptions for energy impact analysis for the proposed code change. Since this proposal is limited to DHW distribution systems with shorter recirculation return pipes, the MidRiseMixedUse and HighRiseMixedUse prototype buildings do not meet the recirculation return pipe length criteria and are omitted from this table. Please see Appendix H for additional details.

Table 119: Key Assumptions for Assessing Energy Impact of Automatic Balancing Valves

Balancing valve configurations, base case and proposed case	<p>Base Case: Manual balancing valves set to have 0.5 GPM recirculation flow per riser</p> <p>Proposed Case: With automatic balancing valves, recirculation flows through risers are adjusted so that water temperature at balancing valves are close to the setpoint.</p>
Pipe sizing method for distribution system, both cases	CPC Appendix A
% of pipes not insulated (Distribution system), both cases	LowRiseGarden: 52%, LoadedCorridor: 43%
Recirculation flow controls, both cases	None

Balancing Valve Assumptions

The Statewide CASE Team collected data from multiple sources to determine current practice for balancing valve installation and balancing including interviews with designers, contractors, and design consultants, and by reviewing plumbing permit drawings and construction documents. Previously, the 2022 Statewide CASE Team had determined that circuit setters are the baseline balancing valve.⁵² The 2025 Statewide CASE Team verified that circuit setters are still an appropriate baseline manual balancing valve via plans review and interviews. The Statewide CASE Team verified that new construction generally includes balancing valves, and riser design flow rates for manual valves vary from 0.5 GPM to 2 GPM, but 0.5 GPM is the most common specified flow rate.

Due to the complexity of DHW distribution circulation systems, the Statewide CASE Team made conservative assumptions to simplify the model. These include ignoring savings due to increased plant efficiency and improved balance, as compared to poor manual balancing. The Statewide CASE Team chose to only quantify the energy savings potential due to reducing the riser flow rate at each riser (from 0.5 GPM per riser) to what is necessary to maintain a specified temperature at the automatic balancing valve to achieve the desired energy savings and cost-effectiveness results.

For the proposed design, the Statewide CASE Team simplified the energy savings modeling due to modeling limitations. The Statewide CASE Team worked with an experienced plumbing designer to calculate a minimum flow rate at the riser nearest the heating plant based on valve and distribution system hydraulic properties. The Statewide CASE Team applied this minimum flow rate to all risers, which results in a

⁵² https://title24stakeholders.com/wp-content/uploads/2020/09/2022_T24_Final-CASE-Report-MF-DHW-Dist.pdf

conservative estimate of minimum flow rate at each TBV. The Statewide CASE Team then programmed the minimum flow rates as floor values into the recirculation heat loss spreadsheet calculator. The spreadsheet calculator then calculates heat loss based on the larger of two values—the floor minimum flow rate or the flow needed to meet temperature set point, which results in a conservative estimate of energy savings. The Statewide CASE Team also performed lab testing to validate the calculated flows and found reasonable agreement, with the energy modeling for the LRLC prototype being overall conservative compared to the balancing valve tested.

5.3.1.2 Energy Savings Methodology per Prototypical Building

The CEC directed the Statewide CASE Team to assess the energy impacts of proposed code change for four prototypical multifamily buildings. Since this proposal is limited to DHW distribution systems with shorter recirculation return pipes, the MidRiseMixedUse and HighRiseMixedUse prototype buildings do not meet the recirculation return pipe length criteria and are omitted from Table 120. First, savings are calculated by fuel type. Electricity savings are measured in terms of both energy usage and peak demand reduction. Natural gas savings are quantified in terms of energy usage. For each prototypical multifamily building, the Statewide CASE Team used the spreadsheet calculator to obtain hourly recirculation pipe heat loss for both the base case and proposed recirculation system. The Statewide CASE Team then calculated the corresponding hourly DHW system energy consumption (Therms for natural gas systems and kWh for HPWH systems) by dividing the hourly recirculation pipe heat loss by the heating plant efficiency. Annual site energy consumption for recirculation system operation was obtained by summing up the hourly DHW system energy consumption for the whole year. The first-year site energy savings (Therms/yr for natural gas systems and kWh/yr for HPWH systems) of the proposed code change was calculated as the difference in annual site energy consumption between the proposed and base case recirculation systems.

For both the base case and proposed recirculation systems, annual peak electricity demand (kW) was calculated based on weighted average hourly kWh consumption during grid peak hours. Both peak hours and corresponding weighting factors are provided by the CEC. Annual peak reduction (kW) of the proposed code change was calculated as the difference in annual peak electricity demand between the base case and proposed recirculation systems.

Second, the Statewide CASE Team calculated Source Energy Savings. Source Energy represents the total amount of fuel required to operate a building. In addition to all energy used from on-site production, source energy incorporates all transmission, delivery, and production losses. The hourly source energy factors provided by the CEC are strongly correlated to GHG emissions. The Statewide CASE Team calculated source energy use in kilo British thermal units per year (kBtu/yr) by applying source

energy factors to hourly DHW system energy consumption and summing the hourly results for the whole year. Source Energy Savings is calculated as the difference in source energy use between the base and the proposed cases.

The hourly source energy values provided by the CEC are strongly correlated with GHG emissions.⁵³ The Statewide CASE Team calculated GHG emissions (metric tons of carbon dioxide emissions equivalent) by applying hourly GHG emissions factors to hourly DHW system energy consumption and summing the hourly results for the whole year. GHG emissions reduction is calculated as the difference in GHG emissions between the base and the proposed cases.

Finally, the Statewide CASE Team calculated LSC savings, formerly known as TDV energy cost savings. LSC savings are calculated using hourly energy cost metrics for both electricity and natural gas provided by the CEC. These LSC hourly factors are projected over the 30-year life of the building, and it incorporates the hourly cost of marginal generation, transmission and distribution, fuel, capacity, losses, and cap-and-trade-based CO2 emissions.¹² The Statewide CASE Team applied 2025 LSC hourly factors to hourly DHW system energy consumption and summed up hourly results for the whole year to obtain LSC in 2026 PV\$. LSC savings are the difference in LSC between the base and proposed cases.

Table 120: Prototype Buildings Used for Energy, Demand, Cost, and Environmental Impacts Analysis

Prototype Name	Number of Stories	Floor Area (Square Feet)	Description
LowRise Garden	2	7,680	8-unit apartment building. Gas fired and HPWH central DHW heater serving a central recirculation loop. Water heater is located on one end the of building at the ground level. Distribution piping runs horizontally in ceiling of ground floor, vertically up four risers, and returns in the ceiling of the second floor. ⁵⁴
Loaded Corridor	3	40,000	36-unit apartment building. Gas fired and HPWH central DHW heater serving a central recirculation loop. Water heater is located in a mechanical room at the ground level. Distribution piping runs horizontally in ceiling of ground floor, vertically up 13 risers, and returns in the ceiling of the third floor.

⁵³ See hourly factors for source energy, LSC, and GHG emissions at <https://www.energy.ca.gov/files/2025-energy-code-hourly-factors>

⁵⁴ This DHW Distribution CASE topic and the Central HPWH CASE topic are analyzing a central system in the Low-Rise Garden prototype. The Low-Rise Garden prototype for other CASE topics assumes individual water heaters for each dwelling unit.

There are no existing requirements in Title 24, Part 6 that cover the building system in question. The Statewide CASE Team modified the Standard Design, so it calculated energy impacts of the most common current design practice or industry standard practice.

The Proposed Design was identical to the Standard Design in all ways except for the revisions that represent the proposed changes to the code. Table 121 presents precisely which parameters were modified and what values were used in the Standard Design and Proposed Design.

Table 121: Modifications Made to Standard Design in Each Prototype to Simulate Proposed Code Change

Prototype ID	Climate Zone	Objects Modified	Parameter Name	Standard Design Parameter Value	Proposed Design Parameter Value
LowRise Garden	All	DHW Distribution	Riser flow rate	0.5	The larger of: 1. What is necessary to maintain a specified temperature at the automatic balancing valve, or 2. Minimum flow rate at first riser due to valve and distribution system hydraulics
Loaded Corridor	All	DHW Distribution	Riser flow rate	0.5	The larger of: 1. What is necessary to maintain a specified temperature at the automatic balancing valve, or 2. Minimum flow rate at first riser due to valve and distribution system hydraulics

The Statewide CASE Team calculates whole-building energy consumption for every hour of the year measured in kilowatt-hours per year (kWh/yr) and therms per year (therms/yr). It then applies the 2025 LSC hourly factors to calculate LSC costs in 2026 PV\$, Source Energy hourly factors to calculate source energy use in kilo British thermal units per year (kBtu/yr), and hourly GHG emissions factors to calculate annual GHG emissions in metric tons of carbon dioxide emissions equivalent per year (MT or “tonnes” CO₂e/yr).

The energy impacts of the proposed code change vary by climate zone. However, the variations in site energy savings are small (less than 1 percent). For the loaded corridor prototype building, the Statewide CASE Team assessed the energy impacts in every climate zone and applied the climate-zone specific LSC hourly factors when calculating energy and energy cost impacts. The variations in site energy savings are small (less

than 1 percent). Therefore, for the other three prototype buildings, the Statewide CASE Team assessed the energy impacts for Climate Zones 3, 9, 12, and 15, and it then extrapolated to the other climate zones according to the variation among climate zones for the base case.

Per-unit energy impacts for multifamily buildings are presented in savings per residential unit. Annual energy and peak demand impacts for each prototype building were translated into impacts per dwelling unit by dividing by the number of dwelling units in the prototype building. This step enables a calculation of statewide savings using the construction forecast that is published in terms of number of multifamily dwelling units by climate zone.

5.3.1.3 Statewide Energy Savings Methodology

The per-unit energy impacts were extrapolated to statewide impacts using the statewide construction forecasts that the CEC provided (California Energy Commission 2022). The statewide construction forecasts estimate new construction/additions that would occur in 2026, the first year that the 2025 Title 24, Part 6 requirements are in effect. The statewide forecasts also estimate the amount of total existing building stock in 2026, which the Statewide CASE Team used to approximate savings from building alterations. The construction forecast provides construction (new construction/additions and existing building stock) by building type and climate zone, as shown in Appendix A. The Statewide CASE Team accounted separately for normal market adoption of variable speed pumps, and for normal market adoption of automatic balancing valves meeting the temperature set point requirements of the proposal. Based on the results of the plans review conducted by the Statewide CASE Team, normal market adoption rates were determined to be 25 percent for TBVs.

Appendix A: Statewide Savings Methodology presents additional information about the methodology and assumptions used to calculate statewide energy impacts.

5.3.2 Per-Unit Energy Impacts Results

Energy savings and peak demand reductions per unit are presented in Table 122 through Table 128. The energy savings due to additions and alterations are assumed to be the same as the energy savings due to new construction. The energy savings results presented in this report may understate real world savings in all cases due to poor balancing practices that are not reflected in the energy calculations due to a lack of supporting quantitative data. The per-unit energy savings figures do not account for naturally occurring market adoption or compliance rates.

For HPWH-Balancing-Valve-Temp-120 LowRiseGarden, per-unit annual savings are expected to range from 34 to 48 kWh/unit depending upon climate zones. There is no gas usage in all climate zones for both base case and proposed case. Demand

reductions are expected to range between 4 kW and 6 kW depending on the climate zone.

For HPWH-Balancing-Valve-Temp-120 LoadedCorridor, per-unit annual savings are expected to range from 11 to 12 kWh/unit depending upon climate zones. There is no gas usage in all climate zones for both base case and proposed case. Demand reductions are expected to be 1 kW.

For Gas- Balancing-Valve-Temp-120 LowRiseGarden, there are no per-unit electricity saving in all climate zones for the base case. The per -unit natural gas savings range from 114 to 204. There are no demand reductions for any of the climate zone.

For Gas- Balancing-Valve-Temp-120 LoadedCorridor, there are no per-unit electricity saving in all climate zones for the base case. The per -unit natural gas savings range from 46 to 53. There are no demand reductions for any of the climate zone.

Table 122: Annual Electricity Savings (kWh) Per Dwelling Unit by Climate Zone (CZ) - HPWH-Balance-Valve-Temp-120

Prototype	CZ 1	CZ 2	CZ 3	CZ 4	CZ 5	CZ 6	CZ 7	CZ 8	CZ 9	CZ 10	CZ 11	CZ 12	CZ 13	CZ 14	CZ 15	CZ 16
LowRiseGarden	48	44	44	43	46	42	42	41	34	42	43	45	42	43	44	44
LoadedCorridor	12	11	11	11	12	11	11	11	12	11	11	12	11	11	12	11

Table 123: Annual Peak Demand Reductio (kW) Per Dwelling Unit - HPWH-Balance-Valve-Temp-120

Prototype	CZ 1	CZ 2	CZ 3	CZ 4	CZ 5	CZ 6	CZ 7	CZ 8	CZ 9	CZ 10	CZ 11	CZ 12	CZ 13	CZ 14	CZ 15	CZ 16
LowRiseGarden	6	5	5	5	5	5	5	5	4	5	5	5	5	5	5	5
LoadedCorridor	1	1	1	1	1	1	1	1	1	1	1	1	1	1	1	1

Table 124: Annual Source Energy Savings (kBtu) Per Dwelling Unit - HPWH-Balance-Valve-Temp-120

Prototype	CZ 1	CZ 2	CZ 3	CZ 4	CZ 5	CZ 6	CZ 7	CZ 8	CZ 9	CZ 10	CZ 11	CZ 12	CZ 13	CZ 14	CZ 15	CZ 16
LowRiseGarden	84	77	73	76	81	75	73	73	56	74	75	75	75	75	72	78
LoadedCorridor	21	20	19	20	21	20	19	19	20	20	20	20	20	20	21	20

Table 125: Annual LSC Savings (kBtu) Per Dwelling Unit - HPWH-Balance-Valve-Temp-120

Prototype	CZ 1	CZ 2	CZ 3	CZ 4	CZ 5	CZ 6	CZ 7	CZ 8	CZ 9	CZ 10	CZ 11	CZ 12	CZ 13	CZ 14	CZ 15	CZ 16
LowRiseGarden	324	295	294	290	310	288	279	279	226	283	288	301	285	287	292	300
LoadedCorridor	83	77	77	75	80	75	73	73	79	74	75	78	74	75	82	78

Table 126: Annual Natural Gas Savings (kBtu) Per Dwelling Unit - Gas-Balance-Valve-Temp-120

Prototype	CZ 1	CZ 2	CZ 3	CZ 4	CZ 5	CZ 6	CZ 7	CZ 8	CZ 9	CZ 10	CZ 11	CZ 12	CZ 13	CZ 14	CZ 15	CZ 16
LowRiseGarden	204	186	187	184	196	181	177	177	144	179	182	192	181	182	188	188
LoadedCorridor	53	48	49	48	51	47	46	46	50	46	47	49	47	47	52	49

Table 127: Annual Source Energy Savings (kBtu) Per Dwelling Unit - Gas-Balance-Valve-Temp-120

Prototype	CZ 1	CZ 2	CZ 3	CZ 4	CZ 5	CZ 6	CZ 7	CZ 8	CZ 9	CZ 10	CZ 11	CZ 12	CZ 13	CZ 14	CZ 15	CZ 16
LowRiseGarden	185	168	170	166	177	163	159	159	129	161	165	173	164	164	169	169
LoadedCorridor	48	44	44	43	46	42	41	41	45	42	43	45	43	42	47	44

Table 128: Annual LSC Savings (kBtu) Per Dwelling Unit - Gas-Balance-Valve-Temp-120

Prototype	CZ 1	CZ 2	CZ 3	CZ 4	CZ 5	CZ 6	CZ 7	CZ 8	CZ 9	CZ 10	CZ 11	CZ 12	CZ 13	CZ 14	CZ 15	CZ 16
LowRiseGarden	244	222	222	220	234	217	213	211	171	214	218	227	216	218	223	225
LoadedCorridor	63	58	58	57	61	56	55	55	60	56	57	59	56	57	62	58

5.4 Cost and Cost-Effectiveness

5.4.1 Energy Cost Savings Methodology

Energy cost savings were calculated by applying the LSC hourly factors to the energy savings estimates that were derived using the methodology described in Section 5.3.1. LSC hourly factors are a normalized metric to calculate energy cost savings that accounts for the variable cost of electricity and natural gas for each hour of the year, along with how costs are expected to change over the 30-year period of analysis.

The CEC requested energy cost savings over the 30-year period of analysis in both 2026 PV\$ and nominal dollars. The cost-effectiveness analysis uses LSC values in 2026 PV\$. Costs and cost-effectiveness using 2026 PV\$ are presented in Section 5.4.5 of this report. The CEC uses results in nominal dollars to complete the Economic and Fiscal Impacts Statement (From 399) for the entire package of proposed change to Title 24, Part 6. Appendix G: Energy Cost Savings in Nominal Dollars presents LSC savings results in nominal dollars.

5.4.2 Energy Cost Savings Results

Per-unit energy cost savings for newly constructed buildings, additions, and alterations in terms of LSC savings realized over the 30-year period of analysis are presented 2026 PV\$ in Table 129 through Table 136.

The LSC methodology allows peak electricity savings to be valued more than electricity savings during non-peak periods. This measure addresses energy savings both during peak and non-peak hours

Any time code changes impact cost, there is potential to disproportionately impact DIPs. Refer to Section 5.6 for more details addressing energy equity and environmental justice.

Table 129: 2026 Present Value LSC Savings Per Dwelling Unit Over 30-Year Period of Analysis – New Construction & Additions – LowRiseGarden - HPWH-Balance-Valve-Temp-120

Climate Zone	30-Year LSC Electricity Savings (2026 PV \$)	30-Year LSC Gas Savings (2026 PV \$)	Total 30-Year LSC Savings (2026 PV \$)
1	324	0	324
2	295	0	295
3	294	0	294
4	290	0	290
5	310	0	310
6	288	0	288
7	279	0	279
8	279	0	279
9	226	0	226
10	283	0	283
11	288	0	288
12	301	0	301
13	285	0	285
14	287	0	287
15	292	0	292
16	300	0	300

Table 130: 2026 Present Value LSC Savings Per Dwelling Unit Over 30-Year Period of Analysis – New Construction & Additions – LoadedCorridor - HPWH-Balance-Valve-Temp-120

Climate Zone	30-Year LSC Electricity Savings (2026 PV \$)	30-Year LSC Gas Savings (2026 PV \$)	Total 30-Year LSC Savings (2026 PV \$)
1	83	0	83
2	77	0	77
3	77	0	77
4	75	0	75
5	80	0	80
6	75	0	75
7	73	0	73
8	73	0	73
9	79	0	79
10	74	0	74
11	75	0	75
12	78	0	78
13	74	0	74
14	75	0	75
15	82	0	82
16	78	0	78

Table 131: 2026 Present Value LSC Savings Per Dwelling Unit Over 30-Year Period of Analysis – New Construction & Additions – LowRiseGarden - Gas-Balance-Valve-Temp-120

Climate Zone	30-Year LSC Electricity Savings (2026 PV \$)	30-Year LSC Gas Savings (2026 PV \$)	Total 30-Year LSC Savings (2026 PV \$)
1	0	244	244
2	0	222	222
3	0	222	222
4	0	220	220
5	0	234	234
6	0	217	217
7	0	213	213
8	0	211	211
9	0	171	171
10	0	214	214
11	0	218	218
12	0	227	227
13	0	216	216
14	0	218	218
15	0	223	223
16	0	225	225

Table 132: 2026 Present Value LSC Savings Per Dwelling Unit Over 30-Year Period of Analysis – New Construction & Additions – LoadedCorridor - Gas-Balance-Valve-Temp-120

Climate Zone	30-Year LSC Electricity Savings (2026 PV \$)	30-Year LSC Gas Savings (2026 PV \$)	Total 30-Year LSC Savings (2026 PV \$)
1	0	63	63
2	0	58	58
3	0	58	58
4	0	57	57
5	0	61	61
6	0	56	56
7	0	55	55
8	0	55	55
9	0	60	60
10	0	56	56
11	0	57	57
12	0	59	59
13	0	56	56
14	0	57	57
15	0	62	62
16	0	58	58

Table 133: 2026 Present Value LSC Savings Per Dwelling Unit Over 30-Year Period of Analysis – Alterations – LowRiseGarden - HPWH-Balance-Valve-Temp-120

Climate Zone	30-Year LSC Electricity Savings (2026 PV \$)	30-Year LSC Gas Savings (2026 PV \$)	Total 30-Year LSC Savings (2026 PV \$)
1	\$324	\$0	\$324
2	\$295	\$0	\$295
3	\$294	\$0	\$294
4	\$290	\$0	\$290
5	\$310	\$0	\$310
6	\$288	\$0	\$288
7	\$279	\$0	\$279
8	\$279	\$0	\$279
9	\$226	\$0	\$226
10	\$283	\$0	\$283
11	\$288	\$0	\$288
12	\$301	\$0	\$301
13	\$285	\$0	\$285
14	\$287	\$0	\$287
15	\$292	\$0	\$292
16	\$300	\$0	\$300

Table 134: 2026 Present Value LSC Savings Per Dwelling Unit Over 30-Year Period of Analysis – Alterations – LoadedCorridor - HPWH-Balance-Valve-Temp-120

Climate Zone	30-Year LSC Electricity Savings (2026 PV \$)	30-Year LSC Gas Savings (2026 PV \$)	Total 30-Year LSC Savings (2026 PV \$)
1	\$83	\$0	\$83
2	\$77	\$0	\$77
3	\$77	\$0	\$77
4	\$75	\$0	\$75
5	\$80	\$0	\$80
6	\$75	\$0	\$75
7	\$73	\$0	\$73
8	\$73	\$0	\$73
9	\$79	\$0	\$79
10	\$74	\$0	\$74
11	\$75	\$0	\$75
12	\$78	\$0	\$78
13	\$74	\$0	\$74
14	\$75	\$0	\$75
15	\$82	\$0	\$82
16	\$78	\$0	\$78

Table 135: 2026 Present Value LSC Savings Per Dwelling Unit Over 30-Year Period of Analysis – Alterations – LowRiseGarden - Gas-Balance-Valve-Temp-120

Climate Zone	30-Year LSC Electricity Savings (2026 PV \$)	30-Year LSC Gas Savings (2026 PV \$)	Total 30-Year LSC Savings (2026 PV \$)
1	\$0	\$244	\$244
2	\$0	\$222	\$222
3	\$0	\$222	\$222
4	\$0	\$220	\$220
5	\$0	\$234	\$234
6	\$0	\$217	\$217
7	\$0	\$213	\$213
8	\$0	\$211	\$211
9	\$0	\$171	\$171
10	\$0	\$214	\$214
11	\$0	\$218	\$218
12	\$0	\$227	\$227
13	\$0	\$216	\$216
14	\$0	\$218	\$218
15	\$0	\$223	\$223
16	\$0	\$225	\$225

Table 136: 2026 Present Value LSC Savings Per Dwelling Unit Over 30-Year Period of Analysis – Alterations – LoadedCorridor - Gas-Balance-Valve-Temp-120

Climate Zone	30-Year LSC Electricity Savings (2026 PV \$)	30-Year LSC Gas Savings (2026 PV \$)	Total 30-Year LSC Savings (2026 PV \$)
1	\$0	\$63	\$63
2	\$0	\$58	\$58
3	\$0	\$58	\$58
4	\$0	\$57	\$57
5	\$0	\$61	\$61
6	\$0	\$56	\$56
7	\$0	\$55	\$55
8	\$0	\$55	\$55
9	\$0	\$60	\$60
10	\$0	\$56	\$56
11	\$0	\$57	\$57
12	\$0	\$59	\$59
13	\$0	\$56	\$56
14	\$0	\$57	\$57
15	\$0	\$62	\$62
16	\$0	\$58	\$58

5.4.3 Incremental First Cost

This measure proposes a compliance option. As such, a cost analysis is not required. The Statewide CASE Team had previously considered proposing the measure as a prescriptive requirement, however the Statewide CASE Team decided that more research would be needed to understand valve dynamics and switched the measure to a compliance option. Because the Statewide CASE Team obtained cost data while considering pursuing the measure as a prescriptive requirement, that data is presented here.

Incremental first cost is the initial cost to adopt more efficient equipment or building practices as compared to the cost of an equivalent baseline project. The Statewide CASE Team considers first costs in evaluating overall measure Cost-Effectiveness. Incremental first costs are based on data currently available and can change over time as markets evolve and professionals become familiar with new technology and building practices.

For both the baseline and proposed systems, the Statewide CASE Team gathered costs related to the automatic balancing valves measure. The difference between the baseline and proposed systems costs is the incremental cost.

The Statewide CASE Team developed a basis of design for each prototype described in Section 5.3.1.2 and worked with two mechanical contractors to estimate costs for the bases of design. The mechanical contractors provided material and labor cost estimates for complete installation of the balancing valves, disaggregated by the valve product, circulation pump product, valve balancing, pump setup, general conditions and overhead, design and engineering, permit, testing, and inspection, and a contractor profit or market factor.

The Statewide CASE Team obtained pricing estimates based on one circuit setter type manual balancing valve and two TBVs. The results of the incremental first cost analysis indicate that the measure reduces cost for new construction, additions, and alterations. The first cost savings results lines up with stakeholder interviews and was confirmed by feedback received at the first hot water stakeholder meeting.

Table 137: Total Component Count and Type: Base Case

MF Building Type	Attribute	Manual TBV	Pumps
Low-Rise Garden	Manufacturer	B&G	Grundfos
	Model No.	CB-1/2S LF	UP15-18 B5
	Components	4	1
Low-Rise Loaded Corridor	Manufacturer	B&G	Grundfos
	Model No.	CB-1/2S LF	UPS 26-99 SFC (Speed 1)
	Components	13	1
Mid-Rise Mixed Use	Manufacturer	B&G	Grundfos
	Model No.	CB-1/2S LF	UPS 26-99 SFC (Speed 2)
	Components	22	1
High-Rise Mixed Use	Manufacturer	B&G	Grundfos
	Model No.	CB-1/2S LF	UP 15-18 B7
	Components	26	2

Table 138: Total Component Count and Type: Proposed Case

MF Building Type	Attribute	Fixed Setpoint TBV	Adjustable Setpoint TBV	Variable Speed Capable Pumps
Low-Rise Garden	Manufacturer	Circuitsolver	Caleffi	Grundfos
	Model No.	CS-1/2-115	116140A Thermostat 1/2"	Alpha1 15-55F
	# Components	4	4	1
Low-Rise Loaded Corridor	Manufacturer	Circuitsolver	Caleffi	Grundfos
	Model No.	CS-1/2-115	116140A Thermostat 1/2"	Alpha1 15-55F
	# Components	13	13	1
Mid-Rise Mixed Use	Manufacturer	Circuitsolver	Caleffi	Grundfos
	Model No.	CS-1/2-115	116140A Thermostat 1/2"	Alpha1 15-55F
	# Components	22	22	1
High-Rise Mixed Use	Manufacturer	Circuitsolver	Caleffi	Grundfos
	Model No.	CS-1/2-115	116140A Thermostat 1/2"	Alpha1 15-55F
	# Components	26	26	2

The Statewide CASE Team received balancing valve costs, pump costs, and labor hours from a mechanical contractor as shown in Table 139, Table 140, and Table 141. The data we received from the contractor lines up qualitatively with what we heard from other stakeholders, which is that balancing manual valves correctly is time consuming and costly. Two different balancing valve types, fixed set point and adjustable set point, were priced to provide additional insights. The Statewide CASE Team based the cost analysis on the adjustable valve. The material costs include the valves and pumps

themselves as well as other installation materials. The labor hours are those to install the valves and pumps.

Table 139: Material and Labor Costs for Base Case

MF Building Type	Average Material Cost	Material Labor Hours	Labor Rate	Total Cost
Low-Rise Garden Style	\$1,010	15.01	\$100	\$2,511
Low-Rise Loaded Corridor	\$2,743	24.02	\$100	\$5,146

Table 140: Material and Labor Costs for Proposed Case-TBV

MF Building Type	Average Material Cost	Material Labor Hours	Labor Rate	Total Cost
Low-Rise Garden Style	\$1,179	11.01	\$100	\$2,281
Low-Rise Loaded Corridor	\$2,907	20.02	\$100	\$4,909

Using the provided material and labor costs the Statewide CASE Team was able to calculate total installed costs for the base case and both proposed cases. From those installed costs the Statewide CASE Team was then able to distill an incremental cost of installation for each multifamily building type, as well as an average incremental cost per dwelling unit, as shown in Table 141.

Table 141: Incremental Costs for Base Case vs Proposed Case-TBV

MF Building Type	Base Case	Proposed Case- TBV	Total Incremental Cost	Average Incremental Cost per Dwelling Unit
Low-Rise Garden Style	\$2,511	\$2,281	-\$230	-\$29
Low-Rise Loaded Corridor	\$5,146	\$4,909	-\$237	-\$7

5.4.4 Incremental Maintenance and Replacement Costs

Incremental maintenance cost is the incremental cost of replacing the equipment or parts of the equipment, as well as periodic maintenance required to keep the equipment operating relative to current practices over the 30-year period of analysis. The present value of equipment maintenance costs (or savings) was calculated using a three percent discount rate (d), which is consistent with the discount rate used when developing the 2025 Lifecycle Cost Hourly Factors. The present value of maintenance costs that occurs in the nth year is calculated as follows:

$$Present\ Value\ of\ Maintenance\ Cost = Maintenance\ Cost \times \left[\frac{1}{1+d} \right]^n$$

The persistence of measure savings is dependent on replacement of the TBV at the end of life, maintenance of the proper temperature set point after installation, and maintenance of the variable speed pump. The TBV has additional moving parts as compared to the baseline circuit setter valves, which means there are additional potential failure points. On the other hand, the TBV is more resilient to changes in the distribution system including changes in fixture and piping layout, sedimentation, and mineral deposits in the piping. The main difference between the variable speed pump and the base case constant speed pump is onboard sensors and controls, however the variable speed operation would also reduce wear on the pump due to lower pump operating speeds and pressures.

The Statewide CASE Team determined by anecdotal means that replacement of pumps and valves would occur at an average of every fifteen years. This being the case The Statewide CASE Team developed the following tables to quantify the incremental costs associated with the replacement of the equipment.

Table 142: Replacement Material and Labor Costs for Base Case

MF Building Type	Average Material Cost	Material Labor Hours	Labor Rate	Total Cost
Low-Rise Garden Style	\$808	18.76	\$100	\$2,684
Low-Rise Loaded Corridor	\$2,194	30.02	\$100	\$5,196

Table 143: Replacement Material and Labor Costs for Proposed Case

MF Building Type	Average Material Cost	Material Labor Hours	Labor Rate	Total Cost
Low-Rise Garden Style	\$943	13.76	\$100	\$2,319
Low-Rise Loaded Corridor	\$2,326	25.02	\$100	\$4,828

Table 144: Incremental Replacement Costs for Base Case vs Proposed Case

MF Building Type	Base Case	Proposed Case- TBV	Total Incremental Cost	Average Incremental Cost per Dwelling Unit
Low-Rise Garden Style	\$2,684	\$2,319	-\$365	-\$46
Low-Rise Loaded Corridor	\$5,196	\$4,828	-\$368	-\$10

5.4.5 Cost-Effectiveness

This measure proposes a compliance option. As such, a cost analysis is not required. The Statewide CASE Team had previously considered proposing the measure as a prescriptive requirement, however the Statewide CASE Team decided that more research would be needed to understand valve dynamics and switched the measure to a compliance option. Because the Statewide CASE Team obtained cost data while

considering pursuing the measure as a prescriptive requirement, that data is presented here.

The CEC establishes the procedures for calculating Cost-Effectiveness. The Statewide CASE Team collaborated with CEC staff to confirm that the methodology in this report is consistent with their guidelines, including which costs were included in the analysis. The incremental first cost and incremental maintenance costs over the 30-year period of analysis were included. The LSC savings from electricity and natural gas savings were also included in the evaluation. Design costs were not included nor were the incremental costs of code compliance verification.

According to the CEC's definitions, a measure is cost effective if the B/C ratio is greater than 1.0. The B/C ratio is calculated by dividing the cost benefits realized over 30 years by the total incremental costs, which includes maintenance costs for 30 years. The B/C ratio was calculated using 2026 PV costs and cost savings.

Results of the per-unit, cost-effectiveness analyses are presented in Table 145 and Table 146 for new construction/additions and alterations, respectively.

This measure does not propose mandatory requirements or a revision to the primary prescriptive requirements. A cost analysis is not necessary because the measure is not proposed to be part of the baseline level of stringency, however the Statewide CASE Team has provided information about the Cost-Effectiveness of the measure since the Team originally considered proposing this as a prescriptive requirement.

The proposed measure saves money over the 30-year period of analysis relative to current practice. The proposed code change is cost effective in every climate zone, including for additions and alterations. Benefits and costs are defined as follows:

- **Benefits: 30-year LSC Savings + Other PV Savings:** Benefits include LSC savings over the 30-year period of analysis (California Energy Commission 2022). Other savings are discounted at a real (nominal – inflation) three percent rate. Other PV savings include incremental first-cost savings if proposed first cost is less than current first cost, incremental PV maintenance cost savings if PV of proposed maintenance costs is less than PV of current maintenance costs, and incremental residual value if proposed residual value is greater than current residual value at end of CASE analysis period.
- **Costs: Total Incremental Present Valued Costs:** Costs include incremental equipment, replacement, and maintenance costs over the period of analysis if PV of proposed costs is greater than PV of current costs. Costs are discounted at a real (inflation-adjusted) three percent rate. If incremental maintenance cost is negative, it is treated as a positive benefit. If there are no total incremental PV costs, the B/C ratio is infinite.

Table 145: 30-Year Cost-Effectiveness Summary Per Dwelling Unit – New Construction/Additions - HPWH-Balance-Valve-Temp-120

Climate Zone	Benefits: LSC Savings + Other PV Cost Savings (2026 PV\$/dwelling unit)	Costs: Total Incremental PV Costs (2026 PV\$/dwelling unit)	B/C Ratio
1	\$130	\$0	Infinite
2	\$130	\$0	Infinite
3	\$125	\$0	Infinite
4	\$128	\$0	Infinite
5	\$133	\$0	Infinite
6	\$117	\$0	Infinite
7	\$113	\$0	Infinite
8	\$115	\$0	Infinite
9	\$114	\$0	Infinite
10	\$116	\$0	Infinite
11	\$118	\$0	Infinite
12	\$122	\$0	Infinite
13	\$117	\$0	Infinite
14	\$118	\$0	Infinite
15	\$124	\$0	Infinite
16	\$123	\$0	Infinite

Table 146: 30-Year Cost-Effectiveness Summary Per Dwelling Unit – Alterations - HPWH-Balance-Valve-Temp-120

Climate Zone	Benefits: LSC Savings + Other PV Cost Savings (2026 PV\$/dwelling unit)	Costs: Total Incremental PV Costs (2026 PV\$/dwelling unit)	B/C Ratio
1	\$143	\$0	Infinite
2	\$144	\$0	Infinite
3	\$138	\$0	Infinite
4	\$141	\$0	Infinite
5	\$146	\$0	Infinite
6	\$129	\$0	Infinite
7	\$125	\$0	Infinite
8	\$126	\$0	Infinite
9	\$123	\$0	Infinite
10	\$127	\$0	Infinite
11	\$130	\$0	Infinite
12	\$134	\$0	Infinite
13	\$128	\$0	Infinite
14	\$129	\$0	Infinite
15	\$136	\$0	Infinite
16	\$135	\$0	Infinite

Table 147: 30-Year Cost-Effectiveness Summary Per Dwelling Unit – New Construction/Additions - Gas-Balance-Valve-Temp-120

Climate Zone	Benefits: LSC Savings + Other PV Cost Savings (2026 PV\$/dwelling unit)	Costs: Total Incremental PV Costs (2026 PV\$/dwelling unit)	B/C Ratio
1	\$90	\$0	Infinite
2	\$93	\$0	Infinite
3	\$88	\$0	Infinite
4	\$91	\$0	Infinite
5	\$94	\$0	Infinite
6	\$82	\$0	Infinite
7	\$80	\$0	Infinite
8	\$80	\$0	Infinite
9	\$82	\$0	Infinite
10	\$81	\$0	Infinite
11	\$83	\$0	Infinite
12	\$85	\$0	Infinite
13	\$82	\$0	Infinite
14	\$82	\$0	Infinite
15	\$87	\$0	Infinite
16	\$86	\$0	Infinite

Table 148: 30-Year Cost-Effectiveness Summary Per Dwelling Unit – Alterations - Gas-Balance-Valve-Temp-120

Climate Zone	Benefits: LSC Savings + Other PV Cost Savings (2026 PV\$/dwelling unit)	Costs: Total Incremental PV Costs (2026 PV\$/dwelling unit)	B/C Ratio
1	\$97	\$0	Infinite
2	\$99	\$0	Infinite
3	\$95	\$0	Infinite
4	\$98	\$0	Infinite
5	\$101	\$0	Infinite
6	\$88	\$0	Infinite
7	\$86	\$0	Infinite
8	\$86	\$0	Infinite
9	\$86	\$0	Infinite
10	\$87	\$0	Infinite
11	\$89	\$0	Infinite
12	\$91	\$0	Infinite
13	\$88	\$0	Infinite
14	\$88	\$0	Infinite
15	\$93	\$0	Infinite
16	\$92	\$0	Infinite

5.5 Annual Statewide Impacts

5.5.1 Statewide Energy and Energy Cost Savings

The Statewide CASE Team calculated the first-year statewide savings for new construction and additions by multiplying the per-unit savings, which are presented in Section 5.3.2, by assumptions about the percentage of newly constructed buildings that would be impacted by the proposed code. The statewide new construction forecast for 2026 is presented in Appendix A, as are the Statewide CASE Team's assumptions about the percentage of new construction that would be impacted by the proposal (by climate zone and building type).

The first-year energy impacts represent the first-year annual savings from all buildings that were completed in 2026. The 30-year energy cost savings represent the energy cost savings over the entire 30-year analysis period. The statewide savings estimates do not take naturally occurring market adoption or compliance rates into account.

The tables below present the first-year statewide energy and energy cost savings from newly constructed buildings and additions (Table 149) and alterations (Table 150) by climate zone. Table 151 presents first-year statewide savings from new construction, additions, and alterations.

While a statewide analysis is crucial to understanding broader effects of code change proposals, there is potential to disproportionately impact DIPs that needs to be considered. Refer to Section 5.6 for more details addressing energy equity and environmental justice.

Table 149: Statewide Energy and Energy Cost Impacts – New Construction and Additions – Balance-Valve-Temp-120

Climate Zone	Statewide New Construction & Additions Impacted by Proposed Change in 2026 (Dwelling Units)	Annual ^a Electricity Savings (GWh)	Annual Peak Electrical Demand Reduction (MW)	Annual Natural Gas Savings (Million Therms)	Annual Source Energy Savings (Million kBtu)	30-Year Present Valued LSC Savings (Million 2026 PV\$)
1	8	0.000	0.000	0.000	0.000	\$0.001
2	73	0.000	0.000	0.000	0.003	\$0.005
3	404	0.001	0.000	0.000	0.019	\$0.030
4	179	0.000	0.000	0.000	0.008	\$0.013
5	15	0.000	0.000	0.000	0.001	\$0.001
6	118	0.000	0.000	0.000	0.005	\$0.009
7	271	0.001	0.000	0.000	0.012	\$0.019
8	452	0.001	0.000	0.000	0.020	\$0.032
9	541	0.001	0.000	0.000	0.025	\$0.039
10	226	0.001	0.000	0.000	0.010	\$0.016
11	62	0.000	0.000	0.000	0.003	\$0.005
12	291	0.001	0.000	0.000	0.014	\$0.022
13	53	0.000	0.000	0.000	0.002	\$0.004
14	76	0.000	0.000	0.000	0.004	\$0.006
15	20	0.000	0.000	0.000	0.001	\$0.002
16	10	0.000	0.000	0.000	0.000	\$0.001
Total	2,797	0.007	0.001	0.001	0.130	\$0.205

a. First-year savings from all buildings completed statewide in 2026.

Table 150: Statewide Energy and Energy Cost Impacts – Alterations – Balance-Valve-Temp-120

Climate Zone	Statewide New Construction & Additions Impacted by Proposed Change in 2026 (Dwelling Units)	Annual ^a Electricity Savings (GWh)	Annual Peak Electrical Demand Reduction (MW)	Annual Natural Gas Savings (Million Therms)	Annual Source Energy Savings (Million kBtu)	30-Year Present Valued LSC Savings (Million 2026 PV\$)
1	82	0.000	0.000	0.000	0.005	\$0.007
2	494	0.002	0.000	0.000	0.025	\$0.040
3	2,579	0.008	0.001	0.001	0.131	\$0.208
4	1,346	0.004	0.000	0.001	0.067	\$0.107
5	213	0.001	0.000	0.000	0.011	\$0.018
6	1,504	0.005	0.001	0.001	0.074	\$0.118
7	1,433	0.004	0.001	0.001	0.069	\$0.110
8	2,402	0.007	0.001	0.001	0.115	\$0.184
9	5,210	0.015	0.002	0.003	0.250	\$0.398
10	1,535	0.005	0.001	0.001	0.075	\$0.119
11	398	0.001	0.000	0.000	0.020	\$0.031
12	2,200	0.007	0.001	0.001	0.114	\$0.181
13	732	0.002	0.000	0.000	0.036	\$0.057
14	389	0.001	0.000	0.000	0.019	\$0.031
15	192	0.001	0.000	0.000	0.010	\$0.016
16	131	0.000	0.000	0.000	0.007	\$0.011
Total	20,839	0.062	0.007	0.010	1.029	\$1.637

a. First-year savings from all buildings completed statewide in 2026.

Table 151: Statewide Energy and Energy Cost Impacts – New Construction, Additions, and Alterations

Construction Type	Annual ^a Electricity Savings (GWh)	Annual Peak Electrical Demand Reduction (MW)	First -Year Natural Gas Savings (Million Therms)	Annual Source Energy Savings (Million kBtu)	30-Year Present Valued LSC Savings (Million 2026 PV\$)
New Construction & Additions	0.007	0.001	0.001	0.130	\$0.205
Alterations	0.062	0.007	0.010	1.029	\$1.637
Total	0.07	0.008	0.01	1.16	\$1.84

a. First-year savings from all alterations completed statewide in 2026.

5.5.2 Statewide GHG Emissions Reductions

The Statewide CASE Team calculated avoided GHG emissions associated with energy consumption using the hourly GHG emissions factors that the CEC developed along with the 2025 LSC hourly factors and an assumed cost of \$123.15 per metric tons of carbon dioxide equivalent emissions (metric tons CO₂e).

The monetary value of avoided GHG emissions based on a proxy for permit costs (not social costs).⁵⁵ The cost-effectiveness analysis presented in Section 5.4.5 of this report does not include the cost savings from avoided GHG emissions. To demonstrate the cost savings of avoided GHG emissions, the Statewide CASE Team disaggregated the value of avoided GHG emissions from the other economic impacts. Table 152 presents the estimated first-year avoided GHG emissions of the proposed code change. During the first year, GHG emissions of 75.5 (metric tons CO₂e) would be avoided.

Table 152: Annual Statewide GHG Emissions Impacts - Balance-Valve-Temp-120

Measure	Electricity Savings ^a (GWh/yr)	Reduced GHG Emissions from Electricity Savings ^a (Metric Tons CO ₂ e)	Natural Gas Savings ^a (Million Therms/yr)	Reduced GHG Emissions from Natural Gas Savings ^a (Metric Tons CO ₂ e)	Total Reduced GHG Emissions ^{ab} (Metric Ton CO ₂ e)	Total Monetary Value of Reduced GHG Emissions ^{bc} (\$)
Balance-Valve-Temp-120	0.07	6.4	0.01	69.1	75.5	\$9,294

- First-year savings from all applicable newly constructed buildings, additions, and alterations completed statewide in 2026.
- GHG emissions savings were calculated using hourly GHG emissions factors alongside the LSC hourly factors published by the CEC here: <https://www.energy.ca.gov/files/2025-energy-code-hourly-factors>
- The monetary value of avoided GHG emissions is based on a proxy for permit costs (not social costs) derived from the 2022 TDV Update Model published by the CEC here: <https://www.energy.ca.gov/files/tdv-2022-update-model>

5.5.3 Statewide Water Use Impacts

The proposed code change would not result in water savings.

⁵⁵ The permit cost of carbon is equivalent to the market value of a unit of GHG emissions in the California Cap-and-Trade program, while social cost of carbon is an estimate of the total economic value of damage done per unit of GHG emissions. Social costs tend to be greater than permit costs. See more on the Cap-and-Trade Program on the California Air Resources Board website: <https://ww2.arb.ca.gov/our-work/programs/cap-and-trade-program>.

5.5.4 Statewide Material Impacts

The proposed scenario impacts the low-rise building prototypes which has some impact on different material usage. In overall, in the proposed condition, Copper, Steel, Plastic and Lead usage would reduce. See Appendix D for more details.

Table 153: Annual Statewide Impacts on Material Use – Thermostatic Balancing Valves

Material	Impact	Per-Unit Impacts (Pounds per Dwelling Unit)	Annual ^a Statewide Impacts (Pounds)
Lead	Decrease	0.000395	8
Copper	Decrease	0.003471	68
Steel	Decrease	0.030355	598
Plastic	Decrease	0.002386	47
Brass	Increase	0.032659	644
TOTAL	-	-	-

a. First-year savings from all buildings completed statewide in 2026.

5.5.5 Other Non-Energy Impacts

Non-energy impacts include improved DHW distribution system delivery performance which directly results in a safer hot water distribution system while increasing occupant comfort and reducing risk to property owners. Safety is improved because poorly balanced buildings tend to have insufficient flow to the risers furthest from the water heater, resulting in lower temperatures than intended and increased risk of legionella. Alternatively in poorly balanced buildings, in some cases the lower temperature at the furthest risers leads to occupant discomfort and complaints and subsequent increase of the hot water supply temperature to the point where scalding can occur at dwelling units served by the risers nearest the water heater. In both cases occupant comfort is compromised, and complaints can impact the buildings reputation.

5.6 Addressing Energy Equity and Environmental Justice

The Statewide CASE Team assessed the potential impacts of the proposed measure on DIPs. See Section 2 for a summary of research methods and potentially impacted populations, as well as other general potential equity impacts (Meng, et al. 2007) (CALEPA 2022).

5.6.1 Potential Impacts

This measure would result in lower construction costs, a reduction in energy costs, and improved hot water delivery, which are discussed in detail in Section 2.2.2, with impacts on potentially impacted populations as described in Section 2.2.1.

6. Master Mixing Valves

6.1 Measure Description

6.1.1 Proposed Code Change

The proposed code change would impact Section 170.2(d) - Prescriptive Approach for Water Heating Systems. It would require the installation of a thermostatic MMV that conforms to the American Society of Sanitation Engineers (ASSE) 1017-2009 standard, *Performance Requirements for Temperature Actuated Mixing Valves for Hot Water Distribution Systems*. The MMV must be installed on the central heating plant hot water supply outlet header leading to the recirculation loop. The MMV shall be installed and commissioned in accordance with manufacturer's instructions and applicable reference appendix. The plumbing plans shall provide MMV installation details and specifications indicating water mixing parameters, if this exceeds the mixing capability of the specified MMV, the designer shall provide valve commissioning instructions to prevent temperature creep.

Additionally, this proposed measure would require minor updates to the compliance software to indicate that a thermostatic MMV is specified. The measures would not add field verification or acceptance tests. This code change proposal would apply to newly constructed buildings only.

6.1.2 Justification and Background Information

6.1.2.1 Justification

The Statewide CASE Team proposes a prescriptive requirement to install a thermostatic MMV in a central domestic water heating plant with recirculation system. Both mechanical and digital MMV are types of thermostatic mixing valves defined by the capability to sense outlet temperature and actively mix the right ratio of incoming hot and cold water to maintain the desired output temperature. MMV are commonly found in four out of five centralized heating plants in multifamily buildings based on a review of new construction building plans throughout California. They are traditionally installed for pathogen and scalding mitigation.

Laboratory testing has shown significant energy savings when a MMV is installed at the heating plant hot water outlet supply line prior to centralized supply and return distribution system, versus mixing downstream at the dwelling unit.

Mechanical MMV are standard practice in the industry, and there is a wide range of product types. Performance varies even with established performance standards. Digital MMV requires less maintenance and offers higher accuracy, performance, and

versatility, and they are more responsive to temperature fluctuations and pressure changes in the hot water system. Digital MMVs more accurately maintain setpoint temperature, and they are designed to operate with modern high efficiency heating plants with recirculation system setups that further mitigate the risk of pathogens.

MMVs are already commonly specified and installed in central domestic water heating systems with recirculation. Based on our review of 22 new construction and retrofit project plumbing drawings, 82 percent of those designs (18 of 22 projects) included MMV (2 digital, 16 mechanical) in the DHW heating plant design, 2 projects utilized MMV at each dwelling unit, and 2 projects did not use MMV.

24-hour application testing of a heat pump-based system at PG&E's ATS Hot Water System Laboratory, which mimicked a building with 44 dwelling units with mechanical or digital MMV installed on the hot water supply header, resulted in an average 10.5 percent reduction in energy use, compared to no MMV installed at the heating plant and simulating hot water tempering at the dwelling unit. This proposed measure leads to lower operating cost of the DHW system, which benefits building owners, operators, and occupants.

This proposed prescriptive measure seeks to codify what is already considered to be good practice and more cost-effective than individual MMV installation at each dwelling unit. With the advance towards central HPWH systems, the use of MMV to precisely control the distribution supply temperature offers higher system COP, load shifting capabilities, and the ability to safely increase storage heating capacity. MMV also improves reliability of single pass heat pumps in certain recirculation return to primary tank design applications.

Digital MMVs offer heating plant energy savings, pump savings from reduced pressure drop, temperature fluctuation reductions between low and high demand periods, and the ability to maintain loop temperature during minimum demand periods (Ali Rahmatmand et al. 2020). One Canadian report of an existing 14-story building that replaced a mechanical MMV with an advanced digital MMV showed 25 percent energy savings at the heating plant and lower recirculation pump operating costs from lower pressure drop through the digital valve (Ali Rahmatmand et al. 2019).

6.1.2.2 Background Information

Designers commonly specify mechanical MMV that utilize paraffin wax or bi-metal designs located on the hot water heating plant outlet header leading to a centralized distribution system with recirculation. This design offers the simplest solution to controlling the temperature in the recirculation loop. While the technology and performance standards of gas and electric water heaters has greatly improved, minimum MMV performance has not improved significantly despite technology improvements, especially with the introduction of digital mixing valves.

ASSE 1017-2009 standard addresses MMV performance (ASSE Scald Awareness Task Group 2017), but the performance baseline is low and not representative of real-world operation in multifamily DHW systems with dynamic draws and continuous recirculation. All major types of mixing valves meet the standard, but it is hard to differentiate the performance of various type valves from their specification sheets based on the standard specifications provided, which include maximum outlet temperature, cold and hot water inlet temperature range, minimum approach (mixed minus hot inlet) temperature, minimum water flow rate, and maximum working pressure.

Specifically, there are no requirements in the standard to verify that the device performs thermostatic mixing or if it can accommodate high recirculation return temperatures (recirculation/cold water inlet approach temperature), and the temperature control requirement is not stringent at $\pm 5^{\circ}\text{F}$ allowable at 6 GPM for a MMV with maximum flow range of 5-40 GPM, and $\pm 7^{\circ}\text{F}$ above 40 GPM. MMVs are tested in the laboratory with a 30°F differential between the incoming cold water to mixed outlet temperature, which does not represent the typical continuous recirculation loop in operation with typically a 5°F differential (Knight 2021) (Freidt 2021).

Leonard Valve began manufacturing thermostatic mixing valves in 1911 (Leonard 2022). While the technology has evolved with digital valves introduced in 2005 by Armstrong International (Young 2010), the performance variation in the marketplace has greatly expanded, and the performance standard has not evolved sufficiently.

Temperature creep is a phenomenon when the distribution loop temperature slowly increases during periods of no draw until it gets close to the tank temperature, as it cannot shed enough heat in a closed loop cycle, and many mechanical MMV by design must flow a portion (approximately 20 percent) of the recirculation return water back to the tank—allowing flow on the hot water inlet side to the MMV to overheat the loop (Freidt 2021). This phenomenon would more often occur with well insulated distribution loops with low temperature drop between the supply and return. Temperature creep can lead to higher distribution loop heat loss and potential for scalding when the first draws are incurred after a long no-draw period that can more commonly occur overnight. Many mechanical MMV require the installation and commissioning of one balancing valve to prevent temperature creep, which is more prevalent in a highly insulated distribution loop. Temperature creep mitigation devices are often integrated into mechanical MMV stations designed for recirculation systems (Acorn 2020) (Leonard 2020) (Lawler 2022). When specifying a standalone MMV, some manufacturers provide a recirculation system schematic directly on their data sheets (Leonard 2018) (Lawler 2022); others reference a separate schematic document (Powers 2017). Some manufacturers do not provide documentation or do not include balancing valves on their diagrams (Holby 2020) (Symmons 2018) (Lawler 2022). In all cases, The Statewide CASE Team could not find documentation on what function the balancing valve(s) plays related to the

MMV and how to commission the balancing valve after reviewing manufacturer's specification sheets and manuals related to their products mentioned above, nor has this guidance been found on building plans reviewed.

The proposed prescriptive requirement is complimentary to several leading HPWH manufacturers' installation guidelines. The Northwest Energy Efficiency Alliance's (NEEA) Advanced Water Heating Specification 8.0 (NEEA 2022) defines four major components of a central HPWH system including, (1) primary heating system, (2) primary storage, (3) temperature maintenance system, and (4) controls, and sensors. Thermostatic mixing valves are a required component of the temperature maintenance system. Historically, mixing valves are used to mitigate pathogen growth and scalding risk. With the advance towards central HPWH systems, the use of advanced mixing valves to precisely control the distribution supply and return temperatures offers additional heating plant performance benefits and distribution loop pipe heat loss savings.

Digital MMV may provide energy savings and energy grid benefits in the following ways:

- Promotes stratification in gas-fired or heat pump-based indirect storage tank systems or integrated hybrid water heaters, leading to higher efficiency operation through forcing most of the recirculated water from the return line to the cold side of the MMV and bypassing the tank(s).
- Minimizes energy waste by limiting cold water intrusion into the distribution loop during draws versus mechanical MMV (Ali Rahmatmand et al. 2019).
- Provides capability to direct up to 100 percent of the return flow back to the distribution system by fully closing off the hot inlet port prevents temperature creep, thus reducing scalding risk and pipe heat loss.
- Offers the following with HP-based heating plants:
 - Supports design flexibility in plumbing the recirculation line back to primary storage tanks without causing tank destratification and potential single pass heat pump malfunction.
 - Provides the capability to store water at elevated temperatures supports load flexibility strategies, such as load shifting, to be incorporated effectively.
 - Mitigates the use of supplemental electric-resistance or natural-gas heating with leading swing tank concept heating plant designs.
- Regulates the heater outlet water temperature much more accurately ($\pm 1-3^{\circ}\text{F}$ of setpoint) than relying on a tank thermostat sensor ($\pm 5^{\circ}\text{F}$ of setpoint), thus allowing the potential to lower heater setpoint and result in lower pipe heat loss.
- Allows for increased stored energy capacity (e.g., $140-180^{\circ}$), which reduces the storage volume requirements while further mitigating pathogen concerns.

- Reduces pressure loss especially when compared to mechanical MMV as they age.
- Responds quickly to pressure fluctuations and is impacted less compared to mechanical MMV that can struggle to regain control to deliver the desired mixed outlet temperature.
- Reduces maintenance through daily exercise function (most models) of the valve to minimize scale build-up and ensures smooth operation compared to mechanical MMV that are impacted by hard water, which affects the mixing accuracy and operation.

Utility research supports this proposed code change through the Statewide Codes and Standards Program administered by PG&E with MMV laboratory testing at PG&E's ATS. This proposal relies on data from recent and ongoing data collection efforts. There have been limited advocacy activities including presenting on preliminary findings at national forums (Delagah 2021), but there are no targeted incentives as energy efficiency research of MMVs is at its infancy.

The Statewide CASE Team is not aware of similar measures being considered in previous Title 24, Part 6 rulemakings for the purpose of energy savings. The use of MMV is mentioned in the Performance Approach Section 11.6.7.3 of the 2022 Nonresidential and Multifamily Compliance Manual. The manual references Joint Appendix (JA) 13.3.1, which states that to qualify for the HPWH Demand Management System performance compliance credit, the system shall include a thermostatic mixing valve that conforms with ASSE 1017 and be installed on the hot water supply line.

The Statewide CASE Team understands that IAPMO is supporting the development of a new ASSE standard focused on digital MMV in DHW continuous recirculation applications that would provide a higher performance bar for the industry, but it is not aware of any other organizations working on specific MMV proposals.

6.1.3 Summary of Proposed Changes to Code Documents

The sections below summarize how the standards, Reference Appendices, ACM Reference Manuals, and compliance forms would be modified by the proposed change.⁵⁶ See Section 11 of this report for detailed proposed revisions to code language.

⁵⁶ Visit EnergyCodeAce.com for trainings, tools, and resources to help people understand existing code requirements.

6.1.3.1 Specific Purpose and Necessity of Proposed Code Changes

Each proposed change to language in Title 24, Part 1 and Part 6 as well as the reference appendices to Part 6 are described below. See Section 11.2 of this report for marked-up code language.

Section: 170.2(d)

Specific Purpose: The specific purpose of this addition is to establish a prescriptive requirement for the installation of MMVs for central DHW heating systems.

Necessity: This addition is necessary to increase heating plant efficiency and reduce hot water distribution heat losses to increase energy efficiency via cost-effective building design standards, as directed by California Public Resource Code Sections 25213 and 25402. The proposed measure codifies what is already considered good engineering design, and it provides building owners and tenants consistent DHW temperatures and mitigates scaling and risk to pathogens.

Reference Appendices

This proposal would modify the sections of the Reference Appendices identified below. See Section 11.3 of this report for the detailed proposed revisions to the text of the Reference Appendices.

RA4.4 Water Heating Measures

RA4.4.20 Multiple Dwelling Units: Master Mixing Valves: The proposed change would add a new section, RA4.4.20, intended for building designers and contractors to provide minimum MMV specification, installation, and commissioning requirements.

6.1.3.2 Specific Purpose and Necessity of Changes to the Nonresidential and Multifamily ACM Reference Manual

The purpose and necessity of proposed changes to the Nonresidential and Multifamily ACM Reference Manual are described below. See Section 11.4 of this report for the detailed proposed revisions to the text of the ACM Reference Manual.

Sections: 6.11.3 DHW Multiple Dwelling Units – Central Water Heating

Specific Purpose: The specific purpose is to provide guidance on using thermostatic MMV as part of the standard design on a central distribution system with recirculation to reduce hot water distribution losses and improve heating plant efficiency.

Necessity: These changes are necessary to enhance the description of the standard design recirculation system with inclusion of mechanical MMV.

6.1.3.3 Summary of Changes to the Nonresidential and Multifamily Compliance Manual

Chapter 11 of the Nonresidential and Multifamily Compliance Manual would need to be revised. Specifically, it would add a summary of the prescriptive measure to the “What’s New” section under 11.6.1.2. Additions to Section 11.6.7 Systems Serving Multiple Dwelling Units would be needed. Subsection 11.6.7.2 Prescriptive Requirements would define the function and importance of a MMV and discuss the need to install and commission the MMV in accordance with manufacturer’s instructions. Subsection 11.6.7.7 Performance Approach would discuss the resulting compliance penalty if electing not to incorporate a MMV for systems serving multiple dwelling units with a recirculation pump.

6.1.3.4 Summary of Changes to Compliance Forms

The proposed code change would modify the compliance forms listed below.

- **2022-LMCC-PLB-E: Domestic Water Heating: Low-Rise Multifamily Certificate of Compliance Domestic Water Heating:** Adds prescriptive requirement questions on if the design team has selected a ASSE 1017 Thermostatic MMV and documented adequately on the plumbing plans.
- **2022-NRCC-PLB-E: Domestic Water Heating: Nonresidential Certificate of Compliance Domestic Water Heating:** Adds a prescriptive requirement question on if the design team has selected a ASSE 1017 Thermostatic MMV and documented adequately on the plumbing plans.
- **2022-LMCI-PLB-E: Domestic Water Heating: Low-Rise Multifamily Certificate of Inspection Domestic Water Heating:** Adds a prescriptive requirement question on if the construction team has installed a ASSE 1017 Thermostatic MMV as instructed on the plumbing plans.
- **2022-NRCI-PLB-E: Domestic Water Heating: Nonresidential Certificate of Inspection Domestic Water Heating:** Adds a prescriptive requirement question on if the construction team has installed a ASSE 1017 Thermostatic MMV as instructed on the plumbing plans.

6.1.4 Regulatory Context

6.1.4.1 Determination of Inconsistency or Incompatibility with Existing State Laws and Regulations

Sections 408.3 and 409.4 discuss the need for thermostatic mixing for scald protection, but they do not specify the location where mixing is required. This proposal does not conflict with the CPC or other parts of the California Energy Standards

(<https://www.dgs.ca.gov/BSC/Codes>). Changes outside of Title 24, Part 6 are not needed.

There are no relevant state or local laws or regulations, and there is no conflict with the current CPC.

There are no other code change proposals under consideration for the 2025 code cycle that overlap with this proposal.

6.1.4.2 Duplication or Conflicts with Federal Laws and Regulations

There are no relevant federal laws or regulations.

6.1.4.3 Difference From Existing Model Codes and Industry Standards

This proposal does rely on the ASSE 1017-2009 standard, *Performance Requirements for Temperature Actuated Mixing Valves for Hot Water Distribution Systems*, which addresses MMV performance. The standard ensures that valves are designed to provide a relatively uniform mixed hot water temperature to the distribution system. The standard allows for an allowable level of temperature fluctuation based on the rated maximum flow rate (ASSE Scald Awareness Task Group 2017). The prescriptive requirement does not exclude any ASSE 1017 certified MMV.

6.1.5 Compliance and Enforcement

When developing this proposal, the Statewide CASE Team considered methods to streamline the compliance and enforcement process and how negative impacts on market actors who are involved in the process could be mitigated or reduced. This section describes how to comply with the proposed code change. It also describes the compliance verification process. This section presents how the proposed changes could impact various market actors.

The compliance verification activities related to this measure that need to occur during each phase of the project are described below:

- **Design Phase:**
 - The licensed engineer of record for the plumbing design (plumbing designer) specifies the MMV product and shall indicate water mixing parameters such as the hot water supply temperature, mixed outlet and return temperature, and recirculation flow rate to quantify the water mix ratio required to ensure the specified MMV does not exceed the mixing capability of the valve.
 - The documentation of this information would be new information being added to the construction documents as this information is not currently included.

- The plumbing designer helps complete LMCC or NRCC compliance documents.
- **Permit Application Phase:**
 - Energy consultants enters the appropriate MMV type in the compliance software if taking the performance approach, and the information is submitted as part of the application package.
 - The energy consultant attests to the accuracy of the energy compliance documentation.
 - The plan checker would review the energy compliance documentation and design drawings to ensure compliance.
 - Added work for the energy consultant including new energy compliance forms, LMCC or NRCC, and new fields in existing energy compliance forms.
- **Construction Phase:**
 - Moderate compliance or enforcement changes are anticipated as contractors currently install MMVs regularly, but not always based on manufacturer's requirements.
 - For digital MMVs, contractors would need to follow design documents and coordinate with manufacturer's representatives to ensure proper installation as well as programming and start-up. Certificate of Installation documents, LMCI/NRCI, would be completed by the installation contractor.
- **Inspection Phase:**
 - Certificate of installation documents, LMCI/NRCI, would be completed by the installation contractor.
 - Building inspector check list needs to be updated to verify LMCI/NRCI compliance documents.

Overall, the compliance and enforcement process of installing MMVs measure would have some changes. The design phase would select the appropriate MMVs to meet the building requirements. If additional compliance credits are being sought, additional compliance documentation would be needed. LMCC/NRCC would be completed by the contractor. Energy consultants would coordinate with the plumbing designer to properly complete compliance documents and reflect correct calculations. Compliance document versions would be updated using LMCC/NRCC suite.

6.2 Market Analysis

6.2.1 Current Market Structure

The Statewide CASE Team performed a market analysis with the goals of identifying current technology availability, current product availability, and market trends. It then considered how the proposed standard may impact the market in general as well as individual market actors. Information was gathered about the incremental cost of complying with the proposed measure. Estimates of market size and measure applicability were identified through research and outreach with stakeholders including utility program staff, CEC staff, and a wide range of industry actors. In addition to conducting personalized outreach, the Statewide CASE Team discussed the current market structure and potential market barriers during a public stakeholder meeting that the Statewide CASE Team held on February 17, 2023.

The Statewide CASE Team interviewed five plumbing designers and one general contractor with a set of MMV-related questions and conducted plans review of 45 buildings. Currently, the specification and installation of mixing valves is considered good engineering practice. Designers are specifying and contractors are installing MMVs in the majority of the DHW systems that the Statewide CASE Team has reviewed. MMVs, when specified, are done so by the plumbing designer. The plumbing contractor is responsible for the installation of the valve.

6.2.2 Technical Feasibility and Market Availability

6.2.2.1 Technical Feasibility

Based on the lab testing results in Section 6.2.2.4, the installation of MMVs results in a nominal 10 percent energy savings over not installing one in a HPWH system and distribution system that mimics a building with 44-dwelling units.

MMVs are already being specified and installed in the majority of central DHW systems, based on 45 new building project drawings the Statewide CASE Team reviewed. The use of MMVs provides more consistent DHW temperature, while balancing the need for proper pathogen mitigation and mitigating scalding risks.

Mechanical MMVs are less complex in their design and generally are lower cost to install than digital valves. Digital MMVs handle the dynamic nature of variable flow water draws at the point of use, and they have additional monitoring, remote adjustment, and other controls built in; reduce maintenance costs; reduce pressure loss and better handle pressure fluctuations and have energy savings benefits even over mechanical MMVs. There are, however, some barriers to the installation of MMVs.

Mechanical valves were originally designed to mix hot and cold water with a greater than 20°F temperature difference between the hot inlet and mixed outlet. Many mechanical

valves are not designed or rated for operation of variable water draw distribution systems with recirculation loops. Mechanical MMVs regulate heater outlet water temperature less accurately and have a slower response that is impacted more by pressure fluctuations. Additionally, mitigating temperature creep during periods of no water draws requires a custom design with two balancing valves if constructed in the field or if it is a significantly more expensive MMV station purchased directly from the manufacturer.

Digital MMVs are more expensive than single mechanical MMVs without temperature creep mitigation, and they are comparable in cost to a high-low type mechanical valve or mixing stations with temperature creep mitigation. Digital MMVs utilize sensors and wiring that can malfunction and need to be repaired or replaced. As well, they require power where a mechanical valve does not.

The Statewide CASE Team believes that this 25 percent energy savings from the digital MMV versus mechanical MMV in a high-rise building from the Canadian study (Ali Rahmatmand et al. 2019) is on the high side and limited laboratory testing at PG&E ATS laboratory has shown savings in the 1 to 4 percent range.

6.2.2.2 Market Availability

Current Market by Hot Water System Type

Based on the review of 45 new building project drawings in California, the MMV distribution by hot water system type in the current market is:

- 18 MF buildings with central MMV at heating plant (82 percent)
- 2 Central heating plants with MMV at dwelling unit (9 percent)
- 2 Central heating plants with no MMV (9 percent)
- Others with individual WH per DU and no recirculation or MMV or unknown (not considered in this measure)

Based on the project data reviewed, 18 percent of centralized systems do not use MMV at the outlet of the heating plant and either mix downstream, at the dwelling unit, or not at all. In addition, 82 percent of the buildings have central MMV at heating plant.

Current Market by MMV Type

The Statewide CASE Team further classified the project data with central MMV at heating plant based on the MMV type:

- 16 Mechanical MMV (89 percent)
 - Paraffin
 - Bi-metal High-Low
 - Bellows
 - Unknown
- 2 Digital MMV (11 percent)

Among the mechanical MMV, the Paraffin or Bi-meal High-Low are the most popular, found in nine and five buildings, respectively. Factory built mixing stations were found in two mechanical and one digital MMV specification. These systems are directly mounted onto Unistrut and would require extensive custom pipe insulation to reduce heat loss. Both projects with mechanical MMV stations specified on the plans integrated balancing valves in the apparatus built in the factory to prevent temperature creep. Six projects specified MMV products from two manufacturers that show balancing valves in recirculation piping diagrams in the documentation. The designers of the six projects did not include any written requirements in the plans to follow manufacturers recirculation piping diagrams or show balancing valves in the mixing valve drawings to indicate that a temperature mitigation system should be installed. Eight projects specified MMV products from four manufacturers that did not show balancing valves in their recirculation loop sketches. In total, from the 16 central heating plant projects with recirculation and mechanical MMV specified, 8 either specified MMV products with built in temperature creep mitigation or specified MMV products where manufacturers diagrams required it. As the Statewide CASE Team proposes to mandate MMV in combination with low heat loss distribution systems, it is important to build in temperature creep mitigation as a requirement, since there is market availability and design guidance already available from manufacturers. Including temperature creep mitigation would ensure designers include this feature in their MMV requirements, provide drawings in and/or reference manufacturers drawings, and provide directions how to commission the balancing valve and MMV correctly.

Current Market by Single or Parallel MMV Design Specification

Designers for nine projects reviewed with mechanical MMVs specified multiple MMVs in parallel for better mixing for DHW systems serving an average of 140 dwelling units. Designers of six smaller buildings with single mechanical MMV units specified served an average of 73 dwelling units. These parallel valve setups are commonly factory built with parallel piping connecting two to four MMV units with common inlets and mixed outlet piping.

6.2.2.3 Designer Interview Results

The Statewide CASE Team conducted designer interviews, with questions involving all DHW multifamily measures. Table 154 shows the results of five designer interviews and rankings of factors that influence MMV specification. Three large multifamily building designers commented that they only specify digital MMV.

Table 154: Designer Interview Results

Ranking of factors that influence MMV specification	Average of 5 Designers
Reliability	High
Regulate the heater outlet water temp. more accurately	High
MMV promotes load shifting by storing water at higher temps	High
MMV reduces the use of ER or NG supplemental heating by storing water at elevated temps	High
Pathogen mitigation	Medium/High
Minimum inlet to outlet temp. differential	Medium/High
Increased storage energy capacity with the aid of MMV to reduce storage volume needs	Medium
Scalding mitigation	Medium
Pressure loss rating	Medium
Zero demand temperature creep mitigation	Medium
Cost	Medium/Low

6.2.2.4 MMV Lab testing

PG&E’s ATS completed lab testing where heat pump-based DHW systems mimicked real-world operation in multifamily buildings with a 120°F mixed hot water outlet, 110°F recirculation return water temperature, and insulated distribution system at average distribution loop heat loss rates of 100 watts per dwelling unit. Four heat pump heating plant types were tested in the first batch of tests in 2022, including single-pass and multi-pass heat pumps with recirculation loop returning to the primary tank and single-pass systems with series and parallel temperature maintenance systems. The 24-hour application testing in an indoor and outdoor test chamber using a real-world sized heating plant, a distribution supply and return system that mimics the pipe heat loss of a representatively sized building, and a medium or average water draw profile to represent the use at the dwelling units provided energy use results for the hot water system:

- With no MMV
- With digital MMV

Additional testing of MMVs at ATS was completed in March 2023 in the single-pass HP return to primary storage tank configuration to mimic a well-insulated distribution system at low distribution loop heat loss rates of 50 watts per dwelling unit and 120°F recirculation loop return temperature to comply with pathogen mitigation requirements:

- With no MMV
- With single mechanical MMV
- With high/low mechanical MMV
- With digital MMV.

The MMV mixed outlet temperature setpoints were adjusted in the range of 122°F to 125°F to meet the mixing capabilities of the specific MMV. The digital MMV had no issues with mixing accurately with a 2°F temperature drop from the mixing valve outlet to recirculation return location at the pump. The high/low mechanical MMV could achieve adequate mixing with a 5°F temperature drop. The single mechanical valve was not able to meet the test requirements to maintain a minimum 120°F mixed outlet or return temperature during application testing and test data was omitted from the preliminary test results provided in Appendix Q. This testing is more representative design industry trends, based energy code on updates to reduce pipe heat loss and ASHRAE Standard 188 and Guideline 12 on reducing the risk of legionella (ASHRAE 2023). The purpose of this additional testing is to better demonstrate the performance variation between MMV technologies with distribution systems operating at higher recirculation flow rates with lower temperature drop between the supply and return piping.

Overall, while testing was limited, the test results are valuable and provided insight into the impact of MMV:

- Preliminary average electricity savings of 10.5 percent from using a mechanical or digital MMV versus no MMV and mimicking mixing at the dwelling unit.
- Digital and high/low mechanical MMV were able to maintain a nominal 120°F outlet temperature during draws.
- Single mechanical MMV was not able to maintain a nominal 120°F outlet temperature during draws.

6.2.3 Market Impacts and Economic Assessments

6.2.3.1 Impact on Builders

Builders of residential and commercial structures are directly impacted by many of the measures proposed by the Statewide CASE Team for the 2025 code cycle. It is within the normal practices of these businesses to adjust their building practices to changes in building codes. When necessary, builders engage in continuing education and training to remain compliant with changes to design practices and building codes.

California's construction industry comprises approximately 93,000 business establishments and 943,000 employees (see Table 155). For 2022, total estimated payroll would be about \$78 billion. Nearly 72,000 of these business establishments and 473,000 employees are engaged in the residential building sector, while another 17,600 establishments and 369,000 employees focus on the commercial sector. The remainder of establishments and employees work in industrial, utilities, infrastructure, and other heavy construction roles (the industrial sector).

Table 155: California Construction Industry, Establishments, Employment, and Payroll in 2022 (Estimated)

Building Type	Construction Sectors	Establishments	Employment	Annual Payroll (Billions \$)
Residential	All	71,889	472,974	31.2
Residential	Building Construction Contractors	27,948	130,580	9.8
Residential	Foundation, Structure, & Building Exterior	7,891	83,575	5.0
Residential	Building Equipment Contractors	18,108	125,559	8.5
Residential	Building Finishing Contractors	17,942	133,260	8.0
Commercial	All	17,621	368,810	35.0
Commercial	Building Construction Contractors	4,919	83,028	9.0
Commercial	Foundation, Structure, & Building Exterior	2,194	59,110	5.0
Commercial	Building Equipment Contractors	6,039	139,442	13.5
Commercial	Building Finishing Contractors	4,469	87,230	7.4
Industrial, Utilities, Infrastructure, & Other (Industrial+)	All	4,206	101,002	11.4
Industrial+	Building Construction	288	3,995	0.4
Industrial+	Utility System Construction	1,761	50,126	5.5
Industrial+	Land Subdivision	907	6,550	1.0
Industrial+	Highway, Street, and Bridge Construction	799	28,726	3.1
Industrial+	Other Heavy Construction	451	11,605	1.4

Source: (State of California n.d.)

The proposed change to require mixing valves would likely affect residential builders but would not impact firms that focus on construction and retrofit of industrial buildings, utility systems, public infrastructure, or other heavy construction. The effects on the residential and commercial building industry would not be felt by all firms and workers, but rather would be concentrated in specific industry subsectors. Table 156 shows the residential building subsectors the Statewide CASE Team expects to be impacted by the changes proposed in this report. Requiring mixing valves for multifamily buildings would likely impact several subsectors as noted below, due to there being no current requirement to install them. The Statewide CASE Team’s estimates of the magnitude of these impacts are shown in Section 6.2.3.

Table 156: Specific Subsectors of the California Residential Building Industry by Subsector in 2022 (Estimated)

Residential Building Subsector	Establishments	Employment	Annual Payroll (Billions \$)
New multifamily general contractors	421	6,344	0.7
New housing for-sale builders	189	3,969	0.5
Residential plumbing and HVAC contractors	9,852	75,404	5.1
Other Residential Equipment Contractors	399	1,789	0.1
Residential Drywall Contractors	1,901	32,631	2.0
Residential Painting Contractors	4,869	26,402	1.3

Source: (State of California n.d.)

6.2.3.2 Impact on Building Designers and Energy Consultants

Adjusting design practices to comply with changing building codes is within the normal practices of building designers. Building codes (including Title 24, Part 6) are typically updated on a three-year revision cycle and building designers and energy consultants engage in continuing education and training in order to remain compliant with changes to design practices and building codes.

Plumbing designers have been specifying MMVs regularly in their designs. Making mechanical MMV a prescriptive requirement in designs simply reinforces the concept that the installation of MMV does save energy in multifamily DHW systems and hopefully moves the market to even more effective mixing valves such as digital MMVs.

Businesses that focus on residential, commercial, institutional, and industrial building design are contained within the Architectural Services sector (NAICS 541310). Table 157 shows the number of establishments, employment, and total annual payroll for Building Architectural Services. The proposed code changes would potentially impact all firms within the Architectural Services sector. The Statewide CASE Team anticipates the impacts for requiring mixing valves to affect firms that focus on multifamily construction.

There is not a NAICS⁵⁷ code specific to energy consultants. Instead, businesses that focus on consulting related to building energy efficiency are contained in the Building Inspection Services sector (NAICS 541350), which is comprised of firms primarily

⁵⁷ NAICS is the standard used by federal statistical agencies in classifying business establishments for the purpose of collecting, analyzing, and publishing statistical data related to the U.S. business economy. NAICS was developed jointly by the U.S. Economic Classification Policy Committee (ECPC), Statistics Canada, and Mexico's Instituto Nacional de Estadística y Geografía, to allow for a high level of comparability in business statistics among the North American countries. NAICS replaced the Standard Industrial Classification (SIC) system in 1997.

engaged in the physical inspection of residential and nonresidential buildings.⁵⁸ It is not possible to determine which business establishments within the Building Inspection Services sector are focused on energy efficiency consulting. The information shown in Table 157 provides an upper bound indication of the size of this sector in California.

Table 157: California Building Designer and Energy Consultant Sectors in 2022 (Estimated)

Sector	Establishments	Employment	Annual Payroll (Millions \$)
Architectural Services^a	4,134	31,478	3,623.3
Building Inspection Services^b	1,035	3,567	280.7

Source: (State of California n.d.)

- a. Architectural Services (NAICS 541310) comprises private-sector establishments primarily engaged in planning and designing residential, institutional, leisure, commercial, and industrial buildings and structures.
- b. Building Inspection Services (NAICS 541350) comprises private-sector establishments primarily engaged in providing building (residential & nonresidential) inspection services encompassing all aspects of the building structure and component systems, including energy efficiency inspection services.

6.2.3.3 Impact on Occupational Safety and Health

The proposed code change does not alter any existing federal, state, or local regulations pertaining to safety and health, including rules enforced by the California DOSH. All existing health and safety rules would remain in place. Complying with the proposed code change is not anticipated to have adverse impacts on the safety or health of occupants or those involved with the construction, commissioning, and maintenance of the building.

6.2.3.4 Impact on Building Owners and Occupants Including Homeowners and Potential First-Time Homeowners

Residential Buildings

According to data from the U.S. Census ACS, there were more than 14.5 million housing units in California in 2021 and nearly 13.3 million were occupied (see Table 158). Most housing units (nearly 9.42 million) were single family homes (either detached or attached), approximately 2 million homes were in buildings containing two to nine

⁵⁸ Establishments in this sector include businesses primarily engaged in evaluating a building's structure and component systems and includes energy efficiency inspection services and home inspection services. This sector does not include establishments primarily engaged in providing inspections for pests, hazardous wastes or other environmental contaminants, nor does it include state and local government entities that focus on building or energy code compliance/enforcement of building codes and regulations.

units, and 2.5 million homes were in multifamily buildings containing 10 or more units. The California Department of Revenue estimated that building permits for 67,300 single family and 54,900 multifamily homes would be issued in 2022, up from 66,000 single family and 53,500 multifamily permits issued in 2021.

Table 158: California Housing Characteristics in 2021^a

Housing Measure	Estimate
Total housing units	14,512,281
Occupied housing units	13,291,541
Vacant housing units	1,220,740
Homeowner vacancy rate	0.7%
Rental vacancy rate	4.3%
Number of 1-unit, detached structures	8,388,099
Number of 1-unit, attached structures	1,030,372
Number of 2-unit structures	348,295
Number of 3- or 4-unit structures	783,663
Number of 5- to 9-unit structures	856,225
Number of 10- to 19-unit structures	740,126
Number of 20+ unit structures	1,828,547
Mobile home, RV, etc.	522,442

Sources: (United States Census Bureau n.d.), (Federal Reserve Economic Data (FRED) n.d.)

a. Total housing units as reported for 2021; all other housing measures estimated based on historical relationships.

Table 159 shows the distribution of California homes by vintage. About 15 percent of California homes were built in 2000 or later and another 11 percent built between 1990 and 1999. The majority of California’s existing housing stock (8.5 million homes – 59 percent of the total) were built between 1950 and 1989, a period of rapid population and economic growth in California. Finally, about 2.1 million homes in California were built before 1950. According to Kenney et al, 2019, more than half of California’s existing multifamily buildings (those with five or more units) were constructed before 1978 when there were no building energy efficiency standards (Kenney 2019).

Table 159: Distribution of California Housing by Vintage in 2021 (Estimated)

Home Vintage	Units	Percent	Cumulative Percent
Built 2014 or later	348,296	2.4	2.4
Built 2010 to 2013	261,221	1.8	4.2
Built 2000 to 2009	1,581,839	10.9	15.1
Built 1990 to 1999	1,596,351	11.0	26.1
Built 1980 to 1989	2,191,354	15.1	41.2
Built 1970 to 1979	2,539,649	17.5	58.7
Built 1960 to 1969	1,915,621	13.2	71.9

Built 1950 to 1959	1,930,133	13.3	85.2
Built 1940 to 1949	841,712	5.8	91.0
Built 1939 or earlier	1,306,105	9.0	100.0
Total housing units	14,512,281	100.0	–

Sources: (United States Census Bureau n.d.), (Federal Reserve Economic Data (FRED) n.d.)

Table 160 shows the distribution of owner- and renter-occupied housing by household income. Overall, about 55 percent of California housing is owner-occupied and the rate of owner-occupancy generally increases with household income. The owner-occupancy rate for households with an income below \$50,000 is only 37 percent, whereas the owner occupancy rate is 71 percent for households earning \$100,000 or more.

Table 160: Owner- and Renter-Occupied Housing Units in California by Income in 2021 (Estimated)

Household Income	Total	Owner Occupied	Renter Occupied
Less than \$5,000	353,493	113,315	240,178
\$5,000 to \$9,999	254,304	74,939	179,366
\$10,000 to \$14,999	495,287	134,633	360,654
\$15,000 to \$19,999	412,498	144,064	268,435
\$20,000 to \$24,999	467,694	169,431	298,264
\$25,000 to \$34,999	906,996	355,968	551,028
\$35,000 to \$49,999	1,319,892	560,453	759,438
\$50,000 to \$74,999	2,036,560	990,769	1,045,791
\$75,000 to \$99,999	1,662,032	920,607	741,425
\$100,000 to \$149,999	2,307,889	1,490,247	817,642
\$150,000 or more	3,074,895	2,337,651	737,244
Total Housing Units	13,291,541	7,292,076	5,999,465

Source: (United States Census Bureau n.d.), (Federal Reserve Economic Data (FRED) n.d.)

Understanding the distribution of California residents by home type, home vintage, and household income is critical for developing meaningful estimates of the economic impacts associated with proposed code changes affecting residents. Many proposed code changes specifically target single family or multifamily residences and so the counts of housing units by building type shown in Table 158 and Table 159 provides the information necessary to quantify the magnitude of potential impacts. Likewise, impacts may differ for owners and renters, by home vintage, and by household income, information provided in Table 160.

Estimating Impacts

For California residents, the proposed code changes would result in lower energy bills. The Statewide CASE Team estimates that on average the proposed change to Title 24, Part 6 would increase construction cost by about \$91 per dwelling unit, but the measure would also result in a savings of \$555 in energy and maintenance cost savings over 30 years, assuming an 80/20 split between gas DWH and HPWH. This is roughly equivalent to a \$0.19 per month increase in payments for a 30-year mortgage and a \$1.54 per month reduction in energy costs. Overall, the Statewide CASE Team expects the 2025 Title 24, Part 6 Standards to save homeowners about \$16 per year relative to homeowners whose dwelling units that are minimally compliant with the 2022 Title 24, Part 6 requirements. As discussed in Section 6.2.4, when homeowners or building occupants save on energy bills, they tend to spend it elsewhere thereby creating jobs and economic growth for the California economy. Energy cost savings can be particularly beneficial to low-income homeowners who typically spend a higher portion of their income on energy bills, often have trouble paying energy bills, and sometimes go without other necessities to save money for energy bills (Association, National Energy Assistance Directors 2011).

6.2.3.5 Impact on Building Component Retailers (Including Manufacturers and Distributors)

While it is not a code requirement for mixing valves to be included in engineering design for DHW systems with recirculation, it is also not unusual to see. The Statewide CASE Team expects a modest increase in mixing valves installed in DHW systems. As such, there would be additional demand on retailers.

6.2.3.6 Impact on Building Inspectors

Table 161 shows employment and payroll information for state and local government agencies in which many inspectors of residential and commercial buildings are employed. Building inspectors participate in continuing education and training to stay current on all aspects of building regulations, including energy efficiency. The Statewide CASE Team, therefore, anticipates the proposed change would have no impact on employment of building inspectors or the scope of their role conducting energy efficiency inspections.

Table 161: Employment in California State and Government Agencies with Building Inspectors in 2022 (Estimated)

Sector	Govt.	Establishments	Employment	Annual Payroll (Million \$)
Administration of Housing Programs ^a	State	18	265	29.0
	Local	38	3,060	248.6
Urban and Rural Development Admin ^b	State	38	764	71.3
	Local	52	2,481	211.5

Source: (State of California, Employment Development Department n.d.)

- a. Administration of Housing Programs (NAICS 925110) comprises government establishments primarily engaged in the administration and planning of housing programs, including building codes and standards, housing authorities, and housing programs, planning, and development.
- b. Urban and Rural Development Administration (NAICS 925120) comprises government establishments primarily engaged in the administration and planning of the development of urban and rural areas. Included in this industry are government zoning boards and commissions.

6.2.3.7 Impact on Statewide Employment

As described in Sections 6.2.3.1 through 6.2.3.6, the Statewide CASE Team does not anticipate significant employment or financial impacts to any sector of the California economy. This is not to say that the proposed change would not have modest impacts on employment in California. In Section 6.2.4, the Statewide CASE Team estimated the proposed change requiring mixing valves would affect statewide employment and economic output directly and indirectly through its impact on builders, designers and energy consultants, and building inspectors. In addition, the Statewide CASE Team estimated how energy savings associated with the proposed change in requiring mixing valves would lead to modest ongoing financial savings for California residents, which would then be available for other economic activities.

6.2.4 Economic Impacts

For the 2025 code cycle, the Statewide CASE Team used the IMPLAN model software⁵⁹, along with economic information from published sources, and professional judgement to develop estimates of the economic impacts associated with each of the proposed code changes. Conceptually, IMPLAN estimates jobs created as a function of incoming cash flow in different sectors of the economy, due to implementing a code or a standard. The jobs created are typically categorized into direct, indirect, and induced employment. For example, cash flow into a manufacturing plant captures direct employment (jobs created in the manufacturing plant), indirect employment (jobs created in the sectors that provide raw materials to the manufacturing plant) and

⁵⁹ IMPLAN employs economic data and advanced economic impact modeling to estimate economic impacts for interventions like changes to the California Title 24, Part 6 code. For more information on the IMPLAN modeling process, see www.IMPLAN.com.

induced employment (jobs created in the larger economy due to purchasing habits of people newly employed in the manufacturing plant). Eventually, IMPLAN computes the total number of jobs created due to a code. The assumptions of IMPLAN include constant returns to scale, fixed input structure, industry homogeneity, no supply constraints, fixed technology, and constant byproduct coefficients. The model is also static in nature and is a simplification of how jobs are created in the macro-economy.

The economic impacts developed for this report are only estimates and are based on limited and to some extent speculative information. The IMPLAN model provides a relatively simple representation of the California economy and, though the Statewide CASE Team is confident that the direction and approximate magnitude of the estimated economic impacts are reasonable, it is important to understand that the IMPLAN model is a simplification of extremely complex actions and interactions of individual, businesses, and other organizations as they respond to changes in energy efficiency codes. In all aspect of this economic analysis, the CASE Authors rely on conservative assumptions regarding the likely economic benefits associated with the proposed code change. By following this approach, the economic impacts presented below represent lower bound estimates of the actual benefits associated with this proposed code change.

Adoption of this code change proposal would result in relatively modest economic impacts through the additional direct spending by those in the residential building and remodeling industry, as well as indirectly as residents spend all or some of the money saved through lower utility bills on other economic activities.⁶⁰ There may also be some nonresidential customers that are impacted by this proposed code change; however, the Statewide CASE Team does not anticipate such impacts to be materially important to the building owner and would have measurable economic impacts.

The Statewide CASE Team anticipates no direct effect on designers or energy consultants nor any impact on building inspectors, so the values in Table 163 and Table 164 are zeroed out to indicate this condition.

⁶⁰ For example, for the lowest income group, the Statewide CASE Team assumes 100 percent of money saved through lower energy bills would be spent, while for the highest income group, the Statewide CASE Team assumes only 64 percent of additional income would be spent.

Table 162: Estimated Impact that Adoption of the Proposed Measure would have on the California Residential Construction

Type of Economic Impact	Employment (Jobs)	Labor Income	Total Value Added	Output
Direct Effects (Additional spending by Residential Builders)	6.7	\$529,844	\$1,810,655	\$2,208,160
Indirect Effect (Additional spending by firms supporting Residential Builders)	2.1	\$156,185	\$254,382	\$438,693
Induced Effect (Spending by employees of firms experiencing “direct” or “indirect” effects)	2.5	\$169,643	\$303,719	\$483,406
Total Economic Impacts	11.2	\$855,672	\$2,368,757	\$3,130,258

Source: Statewide CASE Team analysis of data from the IMPLAN modeling software.⁶¹

Table 163: Estimated Impact that Adoption of the Proposed Measure would have on the California Building Designers and Energy Consultants Sectors

Type of Economic Impact	Employment (Jobs)	Labor Income	Total Value Added	Output
Direct Effects (Additional spending by Building Designers & Energy Consultants)	0.8	\$83,242	\$82,408	\$130,254
Indirect Effect (Additional spending by firms supporting Bldg. Designers & Energy Consultants)	0.3	\$24,785	\$34,446	\$55,452
Induced Effect (Spending by employees of firms experiencing “direct” or “indirect” effects)	0.5	\$31,063	\$55,627	\$88,538
Total Economic Impacts	1.5	\$139,089	\$172,481	\$274,244

Source: Statewide CASE Team analysis of data from the IMPLAN modeling software.

⁶¹ IMPLAN® model, 2020 Data, IMPLAN Group LLC, IMPLAN System (data and software), 16905 Northcross Dr., Suite 120, Huntersville, NC 28078 www.IMPLAN.com

Table 164: Estimated Impact that Adoption of the Proposed Measure would have on California Building Inspectors

Type of Economic Impact	Employment (Jobs)	Labor Income	Total Value Added	Output
Direct Effects (Additional spending by Building Inspectors)	0.1	\$13,998	\$16,600	\$20,173
Indirect Effect (Additional spending by firms supporting Building Inspectors)	0.0	\$1,296	\$2,019	\$3,517
Induced Effect (Spending by employees of Building Inspection Bureaus and Departments)	0.1	\$4,403	\$7,887	\$12,554
Total Economic Impacts	0.2	\$19,698	\$26,507	\$36,243

Source: Statewide CASE Team analysis of data from the IMPLAN modeling software.

6.2.4.1 Creation or Elimination of Jobs

The Statewide CASE Team does not anticipate that the measures proposed for the 2025 code cycle regulation would lead to the creation of new *types* of jobs or the elimination of *existing* types of jobs. In other words, the Statewide CASE Team’s proposed change would not result in economic disruption to any sector of the California economy. Rather, the estimates of economic impacts discussed in Section 6.2.4 would lead to modest changes in employment of existing jobs.

6.2.4.2 Creation or Elimination of Businesses in California

As stated in Section 6.2.4, the Statewide CASE Team’s proposed change would not result in economic disruption to any sector of the California economy. The proposed change represents a modest change to engineering design and piping installation which would not excessively burden or competitively disadvantage California businesses—nor would it necessarily lead to a competitive advantage for California businesses. Therefore, the Statewide CASE Team does not foresee any new businesses being created, nor does the Statewide CASE Team think any existing businesses would be eliminated due to the proposed code changes.

6.2.4.3 Competitive Advantages or Disadvantages for Businesses in California

The proposed code changes would apply to all businesses incorporated in California, regardless of whether the business is located inside or outside of the state.⁶² Therefore, the Statewide CASE Team does not anticipate that these measures proposed for the 2025 code cycle regulation would have an adverse effect on the competitiveness of

⁶² Gov. Code, §§ 11346.3(c)(1)(C), 11346.3(a)(2); 1 CCR § 2003(a)(3) Competitive advantages or disadvantages for California businesses currently doing business in the state.

California businesses. Likewise, the Statewide CASE Team does not anticipate businesses located outside of California would be advantaged or disadvantaged.

6.2.4.4 Increase or Decrease of Investments in the State of California

The Statewide CASE Team analyzed national data on corporate profits and capital investment by businesses that expand a firm’s capital stock (referred to as net private domestic investment, or NPDI).⁶³ As Table 165 shows, between 2017 and 2021, NPDI as a percentage of corporate profits ranged from a low of 18 in 2020 due to the worldwide economic slowdowns associated with the COVID 19 pandemic to a high of 35 percent in 2019, with an average of 26 percent. While only an approximation of the proportion of business income used for net capital investment, the Statewide CASE Team believes it provides a reasonable estimate of the proportion of proprietor income that would be reinvested by business owners into expanding their capital stock.

Table 165: Net Domestic Private Investment and Corporate Profits, U.S.

Year	Net Domestic Private Investment by Businesses, Billions of Dollars	Corporate Profits After Taxes, Billions of Dollars	Ratio of Net Private Investment to Corporate Profits (Percent)
2017	518.473	1882.460	28
2018	636.846	1977.478	32
2019	690.865	1952.432	35
2020	343.620	1908.433	18
2021	506.331	2619.977	19
5-Year Average	-	-	26

Source: (Federal Reserve Economic Data (FRED) n.d.)

The Statewide CASE Team does not anticipate that the economic impacts associated with the proposed measure would lead to significant change (increase or decrease) in investment, directly or indirectly, in any affected sectors of California’s economy. Nevertheless, the Statewide CASE Team can derive a reasonable estimate of the change in investment by California businesses based on the estimated change in economic activity associated with the proposed measure and its expected effect on proprietor income, which the Statewide CASE Team uses a conservative estimate of corporate profits, a portion of which the Statewide CASE Team assumes would be allocated to net business investment.⁶⁴

⁶³ Net private domestic investment is the total amount of investment in capital by the business sector that is used to expand the capital stock, rather than maintain or replace due to depreciation. Corporate profit is the money left after a corporation pays its expenses.

⁶⁴ 26 percent of proprietor income was assumed to be allocated to net business investment; see Table 165.

6.2.4.5 Incentives for Innovation in Products, Materials, or Processes

There are many mixing valves currently on the market that are specified for DHW master mixing in recirculation systems. The Statewide CASE Team does not expect the proposed code change would greatly incentivize for innovation. The only area where the MMV proposed measure requirements may have an impact to incentivize innovation is to ensure MMV are installed and commissioned appropriately. There are installation and commissioning cost savings that are inherent to digital MMVs versus mechanical MMVs or downstream mixing valves at the dwelling unit.

6.2.4.6 Effects on the State General Fund, State Special Funds, and Local Governments

The Statewide CASE Team does not expect the proposed code change would have a measurable impact on the California's General Fund, any state special funds, or local government funds.

Cost of Enforcement

Cost to the State: State government already has budget for code development, education, and compliance enforcement. While state government would be allocating resources to update the Title 24, Part 6 Standards, including updating education and compliance materials and responding to questions about the revised requirements, these activities are already covered by existing state budgets. The costs to state government are small when compared to the overall costs savings and policy benefits associated with the code change proposals.

Cost to Local Governments: All proposed code changes to Title 24, Part 6 would result in changes to compliance determinations. Local governments would need to train building department staff on the revised Title 24, Part 6 Standards. While this re-training is an expense to local governments, it is not a new cost associated with the 2025 code change cycle. The building code is updated on a triennial basis, and local governments plan and budget for retraining every time the code is updated. There are numerous resources available to local governments to support compliance training that can help mitigate the cost of retraining, including tools, training and resources provided by the IOU Codes and Standards program (such as Energy Code Ace). As noted in Section 6.1.5 and Appendix E, the Statewide CASE Team considered how the proposed code change might impact various market actors involved in the compliance and enforcement process and aimed to minimize negative impacts on local governments.

6.2.4.7 Impacts on Specific Persons

While the objective of any of the Statewide CASE Team's proposal is to promote energy efficiency, the Statewide CASE Team recognizes that there is the potential that a

proposed code change may result in unintended consequences. Refer to Section 6.6 for more details addressing energy equity and environmental justice.

6.2.5 Fiscal Impacts

6.2.5.1 Mandates on Local Agencies or School Districts

There are no relevant mandates to school districts, because this only impacts multifamily buildings. There are also no mandates for local agencies because the requirements would be specified at the statewide level through Title 24, Part 6.

6.2.5.2 Costs to Local Agencies or School Districts

There are no costs to school districts, because this only impacts multifamily buildings. For local agencies, the Statewide CASE Team does not anticipate any increase in work for building inspectors.

6.2.5.3 Costs or Savings to Any State Agency

There are no costs or savings to state agencies because they would not be involved in enforcement of the measure.

6.2.5.4 Other Non-Discretionary Cost or Savings Imposed on Local Agencies

There are no added non-discretionary costs or savings to local agencies.

6.2.5.5 Costs or Savings in Federal Funding to the State

There are no costs or savings to federal funding to the state due to the measure. The proposed measure is a relatively small cost which the market would bear. The state would not require federal funding to implement the proposed measure.

6.3 Energy Savings

6.3.1 Energy Savings Methodology

The Statewide CASE Team developed energy savings for this measure on a per-dwelling unit basis from results from lab testing at PG&E ATS. The DHW system testing involved operating a HP-based hot water system in various configurations including with no MMV, mechanical MMV, and digital MMV to test up to four main heating plant designs (Section 6.2.2.4) with distribution systems and draw stations that mimic hot water draws for a 44-dwelling unit building using a medium draw profile. The Statewide CASE Team used the lab testing results to estimate heating plant energy saving percentages for the various configurations and extrapolated the energy savings for all prototypes and other heating plant types. Since simulation software assumes perfect mixing, the Statewide CASE Team estimated energy use with digital MMV in all sixteen

climate zones using the 2025-0.3 Research Version of the CBECC software (California Energy Commission n.d.). The Statewide CASE Team then postprocessed the data using MMV lab testing data to account for the additional energy use changing from digital to mechanical MMV. For the base case, the Statewide CASE Team used the post processed energy saving results from lab testing for each heating plant to account for the additional energy use changing from digital to no MMV.

6.3.1.1 Key Assumptions for Energy Savings Analysis

The Statewide CASE Team used percentages of the different types of MMVs in their energy analysis for buildings, as shown in Table 166 below.

Table 166: MMV Assumptions

Measure	Base Case	Proposed	Prototypes
Prescriptive MMV	No MMV	Digital MMV	All

For the proposed prescriptive measure, the base case for buildings with centralized distribution systems is no MMV, and the proposed case is Digital MMV. The Statewide CASE Team completed post processing to measure energy savings per dwelling unit. For HPWH systems, the Statewide CASE Team used 10.5 percent energy savings with the use of a MMV (from lab testing) in the proposed case versus no MMV in the base case for all building prototypes and heating plant configurations. For gas-fired HWS, the Statewide CASE Team used a 3 percent energy savings with the use of a MMV. The gas energy savings was extrapolated from using lab testing results and references gas water heater efficiency versus water return temperature plots to determine the operating efficiency of the gas-fired hot water system, distribution system heat loss, and total energy use with and without mixing valves.

6.3.1.2 Energy Savings Methodology per Prototypical Building

The CEC directed the Statewide CASE Team to assess the energy impacts of proposed code change for four prototypical multifamily buildings, as shown in Table 167. First, savings are calculated by fuel type. Electricity savings are measured in terms of both energy usage and peak demand reduction. Natural gas savings are quantified in terms of energy usage. The Statewide CASE Team calculated annual site energy consumption for DHW plant by summing the hourly DHW plant energy consumption. The team calculated first-year site energy savings (Therms/yr for natural gas systems and kWh/yr for HPWH systems) of the proposed code change as the difference in annual site energy consumption between the proposed and base cases.

The annual peak electricity demand (kW) was calculated based on weighted average hourly kWh consumption during grid peak hours. Both peak hours and corresponding weighting factors are provided by the CEC. Annual peak reduction (kW) of the proposed

code change was calculated as the difference in annual peak electricity demand between the proposed and base cases.

Second, the Statewide CASE Team calculated Source Energy Savings. Source Energy represents the total amount of raw fuel required to operate a building. In addition to all energy used from on-site production, source energy incorporates all transmission, delivery, and production losses. The Statewide CASE Team calculated source energy use in kilo British thermal units per year (kBtu/yr) by applying source energy factors to hourly DHW plant energy consumption and summing the hourly results for the whole year. Source Energy Savings is calculated as the difference in source energy use between the proposed and base cases.

The hourly source energy values provided by the CEC are strongly correlated with GHG emissions.⁶⁵ The Statewide CASE Team calculated GHG emissions (metric tons of carbon dioxide emissions equivalent) by applying hourly GHG emissions factors to hourly DHW plant energy consumption and summing the hourly results for the whole year. GHG emissions reduction is calculated as the difference in GHG emissions between the proposed and base cases.

Finally, the Statewide CASE Team calculated LSC Savings, formerly known as TDV energy cost savings. LSC Savings are calculated using hourly LSC factors for both electricity and natural gas provided by the CEC. These LSCLSC hourly factors are projected over the 30-year life of the building and incorporate the hourly cost of marginal generation, transmission and distribution, fuel, capacity, losses, and cap-and-trade-based CO2 emissions.¹² The Statewide CASE Team applied 2025 LSC hourly factors to hourly DHW plant energy consumption and summed up hourly results for the whole year to obtain LSC in 2026 PV\$. LSC Savings are the difference in LSC between the proposed and base cases.

⁶⁵ See hourly factors for source energy, LSC, and GHG emissions at <https://www.energy.ca.gov/files/2025-energy-code-hourly-factors>

Table 167: Prototype Buildings Used for Energy, Demand, Cost, and Environmental Impacts Analysis

Prototype Name	Number of Stories	Floor Area (Square Feet)	Description
LowRise Garden	2	7,680	8-unit apartment building. Gas fired and HPWH central DHW heater serving a central recirculation loop. Water heater is located on one end the of building at the ground level. Distribution piping runs horizontally in ceiling of ground floor, vertically up four risers, and it returns in the ceiling of the second floor. ⁶⁶
Loaded Corridor	3	40,000	36-unit apartment building. Gas fired and HPWH central DHW heater serving a central recirculation loop. Water heater is located in a mechanical room at the ground level. Distribution piping runs horizontally in ceiling of ground floor, vertically up 13 risers, and it returns in the ceiling of the third floor.
MidRise MixedUse	5	113,100	(4-story residential, 1-story commercial), 88-unit building. Gas fired and HPWH central DHW heater serving dwelling units from a central recirculation loop. Water heater is located in a mechanical room at the ground level (commercial level). Distribution piping runs horizontally in ceiling of second floor (first residential level), vertically up 22 risers, and it returns in the ceiling of the fifth floor
HighRise MixedUse	10	125,400	10-story (9-story residential, 1-story commercial), Gas fired and HPWH central DHW heater serving dwelling units from a central recirculation loop. Water heater is located on the roof. Distribution piping runs horizontally in ceiling of top floor, vertically down 26 risers. There are two pressure zones divided vertically, each with horizontal supply and return piping.

There are no existing requirements in Title 24, Part 6 that cover the DHW distribution and heating plant system. The Statewide CASE Team modified the Standard Design to calculate energy impacts of the most common current design practice, or industry standard practice.

The Statewide CASE Team calculates whole-building energy consumption for every hour of the year measured in kilowatt-hours per year (kWh/yr) and therms per year (therms/yr). It then applies the 2025 LSC hourly factors to calculate LSC in 2026 PV\$, source energy factors to calculate source energy use in kilo British thermal units per

⁶⁶ This DHW Distribution CASE topic and the Central HPWH CASE topic are analyzing a central system in the Low-Rise Garden prototype. The Low-Rise Garden prototype for other CASE topics assumes individual water heaters for each dwelling unit.

year (kBtu/yr), and hourly GHG emissions factors to calculate annual GHG emissions (metric tons of carbon dioxide emissions equivalent).

The energy impacts of the proposed code change do not vary by climate zone. The lab testing estimates the heating plant energy savings per dwelling unit, which the Statewide CASE Team assumed to be the same across all climate zones. Since savings do not vary by climate zone, the Statewide CASE Team used the statewide average LSC hourly factors when calculating energy and energy cost impacts.

Per-unit energy impacts for multifamily buildings are presented in savings per residential unit. Annual energy and peak demand impacts for each prototype building were translated into impacts per dwelling unit by dividing by the number of dwelling units in the prototype building. This step enables a calculation of statewide savings using the construction forecast that is published in terms of number of multifamily dwelling units by climate zone.

6.3.1.3 Statewide Energy Savings Methodology

The per-unit energy impacts were extrapolated to statewide impacts using the Statewide Construction Forecasts that the CEC provided. The Statewide Construction Forecasts estimate new construction/additions that would occur in 2026, the first year that the 2025 Title 24, Part 6 requirements are in effect. They also estimate the amount of total existing building stock in 2026, which the Statewide CASE Team used to approximate savings from building alterations. The construction forecast provides construction (new construction/additions and existing building stock) by building type and climate zone, as shown in Appendix A.

Appendix A presents additional information about the methodology and assumptions used to calculate statewide energy impacts.

6.3.2 Per-Unit Energy Impacts Results

Energy savings and peak demand reductions per unit are presented in Table 168 through Table 174. The per-unit energy savings figures do not account for naturally occurring market adoption or compliance rates.

For Prescriptive HPWH Master Mixing Valve LowRiseGarden, per-unit annual savings are expected to range from 91 to 141 kWh/unit depending upon climate zones. There is no per-unit natural gas savings. Demand reductions are expected to range between 41 kW and 60 kW depending on the climate zone.

For Prescriptive HPWH Master Mixing Valve LoadedCorridor, per-unit annual savings are expected to range from 70 to 118 kWh/unit depending upon climate zones. There is no per-unit natural gas savings. Demand reductions are expected to range between 45 kW and 63 kW depending on the climate zone.

For Prescriptive HPWH Master Mixing Valve MidRiseMixedUse, per-unit annual savings are expected to range from 85 to 167 kWh/unit depending upon climate zones. There is no per-unit natural gas savings. Demand reductions are expected to range between 62 kW and 79 kW depending on the climate zone.

For Prescriptive HPWH Master Mixing Valve HighRiseMixedUse, per-unit annual savings are expected to range from 60 to 128 kWh/unit depending upon climate zones. There is no per-unit natural gas savings. Demand reductions are expected to range between 49 kW and 66 kW depending on the climate zone.

For Prescriptive Gas Master Mixing Valve LowRiseGarden, there is no per-unit electricity savings. The per-unit annual natural gas savings are expected to range from 496 to 1004 kWh/unit. There are no demand reductions.

For Prescriptive Gas Master Mixing Valve LoadedCorridor, there is no per-unit electricity savings. The per-unit annual natural gas savings are expected to range from 223 to 1044 kWh/unit. There are no demand reductions.

For Prescriptive Gas Master Mixing Valve MidRiseMixedUse, there is no per-unit electricity savings. The per-unit annual natural gas savings are expected to range from 930 to 1411 kWh/unit. There are no demand reductions.

For Prescriptive Gas Master Mixing Valve HighRiseMixedUse, there is no per-unit electricity savings. The per-unit annual natural gas savings are expected to range from 692 to 1078 kWh/unit. There are no demand reductions.

Table 168: Annual Electricity Savings (kWh) Per Dwelling Unit by Climate Zone (CZ), Prescriptive HPWH - Master Mixing Valve

Prototype	CZ 1	CZ 2	CZ 3	CZ 4	CZ 5	CZ 6	CZ 7	CZ 8	CZ 9	CZ 10	CZ 11	CZ 12	CZ 13	CZ 14	CZ 15	CZ 16
LowRiseGarden	140	129	126	122	126	113	112	109	110	109	114	120	111	116	91	141
LoadedCorridor	118	107	104	101	104	92	91	88	89	88	93	99	90	94	70	118
MidRiseMixedUse	148	132	129	125	130	114	112	109	110	108	115	122	111	118	85	167
HighRiseMixedUse	110	98	95	92	96	83	81	78	79	78	84	90	81	87	60	128

Table 169: Annual Peak Demand Reduction (kW) Per Dwelling Unit by Climate Zone (CZ), Prescriptive HPWH - Master Mixing Valve

Prototype	CZ 1	CZ 2	CZ 3	CZ 4	CZ 5	CZ 6	CZ 7	CZ 8	CZ 9	CZ 10	CZ 11	CZ 12	CZ 13	CZ 14	CZ 15	CZ 16
LowRiseGarden	55	52	54	60	51	42	41	43	46	47	54	53	52	55	46	43
LoadedCorridor	57	56	56	63	54	46	45	48	50	51	59	58	57	61	51	48
MidRiseMixedUse	70	72	72	79	71	62	62	66	68	69	76	75	75	77	68	75
HighRiseMixedUse	56	59	59	66	58	49	49	52	55	56	64	61	61	65	56	60

Table 170: Annual Source Energy Savings (kBtu) Per Dwelling Unit by Climate Zone (CZ), Prescriptive HPWH - Master Mixing Valve

Prototype	CZ 1	CZ 2	CZ 3	CZ 4	CZ 5	CZ 6	CZ 7	CZ 8	CZ 9	CZ 10	CZ 11	CZ 12	CZ 13	CZ 14	CZ 15	CZ 16
LowRiseGarden	243	229	220	220	221	196	194	193	196	195	211	217	204	216	169	251
LoadedCorridor	196	182	174	174	175	152	150	149	152	150	166	171	159	170	127	202
MidRiseMixedUse	230	210	203	201	203	178	175	172	175	173	190	198	183	198	143	289
HighRiseMixedUse	170	154	148	145	147	127	125	122	125	123	139	144	132	147	100	221

Table 171: Annual LSC Savings (2026 PV\$) Per Dwelling Unit by Climate Zone (CZ), Prescriptive HPWH - Master Mixing Valve

Prototype	CZ 1	CZ 2	CZ 3	CZ 4	CZ 5	CZ 6	CZ 7	CZ 8	CZ 9	CZ 10	CZ 11	CZ 12	CZ 13	CZ 14	CZ 15	CZ 16
LowRiseGarden	2,483	2,234	2,206	2,295	2,103	1,620	1,944	1,747	1,722	1,759	2,153	2,100	2,017	1,952	1,573	1,927
LoadedCorridor	2,419	2,225	2,150	2,316	2,059	1,637	1,958	1,815	1,764	1,828	2,245	2,185	2,112	2,063	1,745	1,986
MidRiseMixedUse	4,056	3,616	3,674	3,728	3,553	2,968	3,342	3,441	3,367	3,521	4,093	3,782	4,056	3,611	3,685	4,074
HighRiseMixedUse	3,188	3,078	2,917	3,204	2,826	2,545	2,751	2,873	2,875	3,006	3,496	3,172	3,456	3,203	3,653	3,210

Table 172: Annual Natural Gas Savings (kBtu) Per Dwelling Unit by Climate Zone (CZ), Prescriptive Gas - Master Mixing Valve

Prototype	CZ 1	CZ 2	CZ 3	CZ 4	CZ 5	CZ 6	CZ 7	CZ 8	CZ 9	CZ 10	CZ 11	CZ 12	CZ 13	CZ 14	CZ 15	CZ 16
LowRiseGarden	1,004	862	846	782	836	733	738	695	694	679	730	785	707	695	496	909
LoadedCorridor	1116	1,044	1,028	963	1,020	961	912	921	923	752	768	825	786	763	658	907
MidRiseMixedUse	1,411	1,310	1,293	1,251	1,300	1,181	1,167	1,139	1,149	1,132	1,166	1,230	1,139	1,177	930	1378
HighRiseMixedUse	1,078	997	984	950	989	894	883	860	868	854	882	933	860	891	692	1052

Table 173: Annual Source Energy Savings (kBtu) Per Dwelling Unit by Climate Zone (CZ), Prescriptive Gas - Master Mixing Valve

Prototype	CZ 1	CZ 2	CZ 3	CZ 4	CZ 5	CZ 6	CZ 7	CZ 8	CZ 9	CZ 10	CZ 11	CZ 12	CZ 13	CZ 14	CZ 15	CZ 16
LoadedCorridor	954	819	804	743	795	692	694	657	656	642	694	746	671	656	469	858
LowRiseGarden	1,030	964	949	890	942	882	834	845	847	690	709	762	726	700	604	833
MidRiseMixedUse	1,300	1,207	1,192	1,154	1,198	1,083	1,066	1,044	1,053	1,038	1,077	1,134	1,051	1,080	854	1,263
HighRiseMixedUse	984	910	898	867	903	811	798	781	788	775	806	852	786	808	629	954

Table 174: Annual LSC Savings (2026 PV\$) Per Dwelling Unit by Climate Zone (CZ), Prescriptive Gas - Master Mixing Valve

Prototype	CZ 1	CZ 2	CZ 3	CZ 4	CZ 5	CZ 6	CZ 7	CZ 8	CZ 9	CZ 10	CZ 11	CZ 12	CZ 13	CZ 14	CZ 15	CZ 16
LowRiseGarden	1,260	1,084	1,063	986	1,049	920	929	876	875	857	925	992	896	881	631	1,815
LoadedCorridor	1,764	1,679	1,657	1,582	1,646	1,577	1,521	1,530	1,533	1,326	1,351	1,418	1,373	1,344	1,215	2,215
MidRiseMixedUse	1,840	1,679	1,634	1,604	1,634	1,447	1,427	1,399	1,420	1,404	1,502	1,571	1,451	1,516	1,147	2,011
HighRiseMixedUse	1,388	1,235	1,213	1,178	1,217	1,094	1,081	1,052	1,064	1,048	1,097	1,156	1,066	1,108	852	1,650

6.4 Cost and Cost-Effectiveness

6.4.1 Energy Cost Savings Methodology

Energy cost savings were calculated by applying the LSC hourly factors to the energy savings estimates that were derived using the methodology described in Section 6.3.1. LSC hourly factors are a normalized metric to calculate energy cost savings that accounts for the variable cost of electricity and natural gas for each hour of the year, along with how costs are expected to change over the 30-year period of analysis.

The CEC requested LSC savings over the 30-year period of analysis in both 2026 PV\$ and nominal dollars. The cost-effectiveness analysis uses LSC values in 2026 PV\$. Costs and cost-effectiveness using 2026 PV\$ are presented in Section 6.4.5 of this report. The CEC uses results in nominal dollars to complete the Economic and Fiscal Impacts Statement (From 399) for the entire package of proposed change to Title 24, Part 6. Appendix G: Energy Cost Savings in Nominal Dollars presents LSC savings results in nominal dollars.

This proposed code change relating to MMVs does not apply to additions and/or alterations.

6.4.2 Energy Cost Savings Results

Per-unit energy cost savings for newly constructed buildings, in terms of LSC savings that are realized over the 30-year period of analysis are presented 2026 PV\$ in Table 175 through Table 182.

The LSC methodology allows peak electricity savings to be valued more than electricity savings during non-peak periods.

Any time code changes impact cost, there is potential to disproportionately impact DIPs. Refer to Section 6.6 for more details addressing energy equity and environmental justice.

Table 175: 2026 PV 30-year LSC Savings – Per Dwelling Unit – New Construction and Additions – LowRiseGarden - Prescriptive HPWH - Master Mixing Valve

Climate Zone	30-Year LSC Electricity Savings (2026 PV \$)	30-Year LSC Gas Savings (2026 PV \$)	Total 30-Year LSC Savings (2026 PV \$)
1	2483	0	2483
2	2234	0	2234
3	2206	0	2206
4	2295	0	2295
5	2103	0	2103
6	1620	0	1620
7	1944	0	1944
8	1747	0	1747
9	1722	0	1722
10	1759	0	1759
11	2153	0	2153
12	2100	0	2100
13	2017	0	2017
14	1952	0	1952
15	1573	0	1573
16	1927	0	1927

Table 176: 2026 PV 30-year LSC Savings – Per Dwelling Unit – New Construction and Additions – LoadedCorridor - Prescriptive HPWH - Master Mixing Valve

Climate Zone	30-Year LSC Electricity Savings (2026 PV \$)	30-Year LSC Gas Savings (2026 PV \$)	Total 30-Year LSC Savings (2026 PV \$)
1	2419	0	2419
2	2225	0	2225
3	2150	0	2150
4	2316	0	2316
5	2059	0	2059
6	1637	0	1637
7	1958	0	1958
8	1815	0	1815
9	1764	0	1764
10	1828	0	1828
11	2245	0	2245
12	2185	0	2185
13	2112	0	2112
14	2063	0	2063
15	1745	0	1745
16	1986	0	1986

Table 177: 2026 PV 30-year LSC Savings – Per Dwelling Unit – New Construction and Additions – MidRiseMixedUsed - Prescriptive HPWH - Master Mixing Valve

Climate Zone	30-Year LSC Electricity Savings (2026 PV \$)	30-Year LSC Gas Savings (2026 PV \$)	Total 30-Year LSC Savings (2026 PV \$)
1	4056	0	4056
2	3616	0	3616
3	3674	0	3674
4	3728	0	3728
5	3553	0	3553
6	2968	0	2968
7	3342	0	3342
8	3441	0	3441
9	3367	0	3367
10	3521	0	3521
11	4093	0	4093
12	3782	0	3782
13	4056	0	4056
14	3611	0	3611
15	3685	0	3685
16	4074	0	4074

Table 178: 2026 PV 30-year LSC Savings – Per Dwelling Unit – New Construction and Additions – HighRiseMixedUsed - Prescriptive HPWH - Master Mixing Valve

Climate Zone	30-Year LSC Electricity Savings (2026 PV \$)	30-Year LSC Gas Savings (2026 PV \$)	Total 30-Year LSC Savings (2026 PV \$)
1	3188	0	3188
2	3078	0	3078
3	2917	0	2917
4	3204	0	3204
5	2826	0	2826
6	2545	0	2545
7	2751	0	2751
8	2873	0	2873
9	2875	0	2875
10	3006	0	3006
11	3496	0	3496
12	3172	0	3172
13	3456	0	3456
14	3203	0	3203
15	3653	0	3653
16	3210	0	3210

Table 179: 2026 PV 30-year LSC Savings – Per Dwelling Unit – New Construction and Additions – LowRiseGarden - Prescriptive Gas - Master Mixing Valve

Climate Zone	30-Year LSCLSC Electricity Savings (2026 PV \$)	30-Year LSC Gas Savings (2026 PV \$)	Total 30-Year LSC Savings (2026 PV \$)
1	0	1260	1260
2	0	1084	1084
3	0	1063	1063
4	0	986	986
5	0	1049	1049
6	0	920	920
7	0	929	929
8	0	876	876
9	0	875	875
10	0	857	857
11	0	925	925
12	0	992	992
13	0	896	896
14	0	881	881
15	0	631	631
16	0	1815	1815

Table 180: 2026 PV 30-year LSC Savings – Per Dwelling Unit – New Construction and Additions – LoadedCorridor - Prescriptive Gas - Master Mixing Valve

Climate Zone	30-Year LSC Electricity Savings (2026 PV \$)	30-Year LSC Gas Savings (2026 PV \$)	Total 30-Year LSC Savings (2026 PV \$)
1	0	1764	1764
2	0	1679	1679
3	0	1657	1657
4	0	1582	1582
5	0	1646	1646
6	0	1577	1577
7	0	1521	1521
8	0	1530	1530
9	0	1533	1533
10	0	1326	1326
11	0	1351	1351
12	0	1418	1418
13	0	1373	1373
14	0	1344	1344
15	0	1215	1215
16	0	2215	2215

Table 181: 2026 PV 30-year LSC Savings – Per Dwelling Unit – New Construction and Additions – MidRiseMixedUse - Prescriptive Gas - Master Mixing Valve

Climate Zone	30-Year LSC Electricity Savings (2026 PV \$)	30-Year LSC Gas Savings (2026 PV \$)	Total 30-Year LSC Savings (2026 PV \$)
1	0	1840	1840
2	0	1679	1679
3	0	1634	1634
4	0	1604	1604
5	0	1634	1634
6	0	1447	1447
7	0	1427	1427
8	0	1399	1399
9	0	1420	1420
10	0	1404	1404
11	0	1502	1502
12	0	1571	1571
13	0	1451	1451
14	0	1516	1516
15	0	1147	1147
16	0	2011	2011

Table 182: 2026 PV 30-year LSC Savings – Per Dwelling Unit – New Construction and Additions – HighRiseMixedUse - Prescriptive Gas - Master Mixing Valve

Climate Zone	30-Year LSC Electricity Savings (2026 PV \$)	30-Year LSC Gas Savings (2026 PV \$)	Total 30-Year LSC Savings (2026 PV \$)
1	0	1388	1388
2	0	1235	1235
3	0	1213	1213
4	0	1178	1178
5	0	1217	1217
6	0	1094	1094
7	0	1081	1081
8	0	1052	1052
9	0	1064	1064
10	0	1048	1048
11	0	1097	1097
12	0	1156	1156
13	0	1066	1066
14	0	1108	1108
15	0	852	852
16	0	1650	1650

6.4.3 Incremental First Cost

Incremental first cost is the initial cost to adopt more efficient equipment or building practices as compared to the cost of an equivalent baseline project. The Statewide CASE Team considers first costs in evaluating overall measure Cost-Effectiveness. Incremental first costs are based on data currently available, and they can change over time as markets evolve and professionals become familiar with new technology and building practices.

The Statewide CASE Team developed a basis of design for each prototype described in Section 6.3.1.2 and worked with two mechanical contractors to estimate costs for each: the basis of design and the proposed case. The mechanical contractors provided material and labor cost estimates for complete installation of the cold and hot water distribution piping, heating plant piping and associated appurtenances, fittings with all the piping, general conditions and overhead, design and engineering, permit, testing, and inspection, and a contractor profit or market factor.

The Statewide CASE Team designed DHW heating plant plumbing systems for each of the prototype buildings according to best engineering practices observed in our plans review, as well as input the Statewide CASE Team received from interviews of several plumbing designers. Based on the DHW heating plant designs, the Statewide CASE Team determined the number and type of MMVs for each prototype building in the base case and the proposed case shown in Table 183 and Table 184. Sizing for MMV can be done several ways, Appendix A maximum flow rates, ASPE rate per ASPE Plumbing Design Engineering Handbook Vol. II, and occupancy rate using building maximum occupancy. The plans review process showed that the overwhelming majority of the piping designs employed CPC Appendix A only and thus the Statewide CASE Team used CPC Appendix A as the basis for sizing.

Table 183: Total Component Count and Type (Proposed Mechanical MMV, not fully analyzed)

Building Type	Attribute	Master Mixing Valve
Low-Rise Garden	Manufacturer	Leonard
	Model No.	TM-520B-LF-DT
	# Components	1
Low-Rise Loaded Corridor	Manufacturer	Leonard
	Model No.	TM-1520B-LF-DT
	# Components	1
Mid-Rise Mixed Use	Manufacturer	Leonard
	Model No.	TM-2020B-2PS-LF
	# Components	1
High-Rise Mixed Use	Manufacturer	Leonard
	Model No.	TM-1520B-2PS-LF
	# Components	2

Table 184: Total Component Count and Type (Proposed Digital MMV, fully analyzed)

Building Type	Attribute	Master Mixing Valve
Low-Rise Garden	Manufacturer	Caleffi
	Model No.	LEGIOMIX 3/4"
	# Components	1
Low-Rise Loaded Corridor	Manufacturer	Caleffi
	Model No.	LEGIOMIX 1"
	# Components	1
Mid-Rise Mixed Use	Manufacturer	Caleffi
	Model No.	LEGIOMIX 1.5"
	# Components	2
High-Rise Mixed Use	Manufacturer	Caleffi
	Model No.	LEGIOMIX 2"
	# Components	2

The Statewide CASE Team received MMV costs and labor hours for both the high-low mechanical and digital MMVs from a mechanical contractor as shown in Table 185 and Table 186. The material costs include the valves as well as other installation materials, and the labor hours are those to install the valves. The base case is no mixing valve installed, whereas the proposed case is a digital mixing valve. Costs were collected for mechanical high-low mixing valves; however, the digital valves were found to be lower cost as can be seen in Table 186 and Table 187. Thus, the Statewide CASE Team selected these valves for use in the Cost-Effectiveness analysis. More and less expensive versions of both the high-low mechanical and the digital MMV's exist on the

market however it was determined by The Statewide CASE Team subject matter expert that the digital MMV best represented a mid-cost range option.

Table 185: MMV Material and Labor Costs for Base Case (CZ Average)

MF Building Type	Material	Labor Hours	Labor Rate	Total
Low-Rise Garden Style	\$0	0	\$100	\$0
Low-Rise Loaded Corridor	\$0	0	\$100	\$0
Mid-Rise Mixed Use	\$0	0	\$100	\$0
High-Rise Mixed Use	\$0	0	\$100	\$0

Table 186: MMV Mechanical High- Low Valve Material and Labor Costs for Proposed Case (CZ Average) (Not used for full analysis)

MF Building Type	Material	Labor Hours	Labor Rate	Total
Low-Rise Garden Style	\$3,253	20	\$100	\$5,256
Low-Rise Loaded Corridor	\$4,339	20	\$100	\$6,342
Mid-Rise Mixed Use	\$11,444	24	\$100	\$13,847
High-Rise Mixed Use	\$20,688	36	\$100	\$24,291

Table 187: MMV Digital Valve Material and Labor Costs for Proposed Case (CZ Average)

MF Building Type	Material	Labor Hours	Labor	Total
Low-Rise Garden Style	\$2,263	8	\$100	\$3,064
Low-Rise Loaded Corridor	\$2,383	8	\$100	\$3,183
Mid-Rise Mixed Use	\$5,038	16	\$100	\$6,640
High-Rise Mixed Use	\$5,311	16	\$100	\$6,912

Using the provided material and labor costs, the Statewide CASE Team was able to calculate total installed costs for the base case and both proposed cases. From those installed costs, the Statewide CASE Team was able to estimate an incremental cost of installation for each multifamily building prototype as well as an average incremental cost per dwelling unit, as shown in Table 188.

Table 188: Incremental Costs for Base Case vs Proposed Case – Prescriptive HPWH - Master Mixing Valve and Gas – Master Mixing Valve

MF Building Type	Base Case	Proposed Case	Total Incremental Cost	Average Incremental Cost Per Dwelling Unit
Low-Rise Garden Style	\$0	\$3,064	\$3,064	\$383
Low-Rise Loaded Corridor	\$0	\$3,183	\$3,183	\$88
Mid-Rise Mixed Use	\$0	\$6,640	\$6,640	\$75
High-Rise Mixed Use	\$0	\$6,912	\$6,912	\$59

6.4.4 Incremental Maintenance and Replacement Costs

Incremental maintenance cost is the incremental cost of replacing the equipment or parts of the equipment, as well as periodic maintenance required to keep the equipment operating relative to current practices over the 30-year period of analysis. The present value of equipment maintenance costs (or savings) was calculated using a three percent discount rate (d), which is consistent with the discount rate used when developing the 2025 Lifecycle Cost Hourly Factors.

The present value of maintenance costs that occurs in the nth year is calculated as follows:

$$\text{Present Value of Maintenance Cost} = \text{Maintenance Cost} \times \left[\frac{1}{1 + d} \right]^n$$

Most digital MMV are designed to operate with daily descaling function that exercises the valve from fully closed to fully open position, such that the scaling typically seen on standard mechanical MMV is virtually eliminated. However, the majority of manufacturers recommend an annual maintenance program to inspect the MMV for removal of debris in the filters, check functionality of unit and check valves, and descaling if necessary. The Statewide CASE Team determined that the average inspection to take 1 hour per year as part of a larger annual maintenance program over the life of the unit. The above present value formula was applied to every year of analysis cost, summed then adjusted by the appropriate climate zone. Table 189 is the average cost across all climate zones for all building prototypes (all building prototypes incur the same cost).

It is assumed that building operators in the majority of cases install water softeners upstream of heating plants, especially since condensing gas-fired heaters and HPWH are especially sensitive to scale caused by hardwater conditions. However, the majority of manufacturers recommend an annual maintenance program to inspect the MMV for removal of debris in the filters, check functionality of unit and check valves, and descaling if necessary. The Statewide CASE Team determined that the average inspection to take 1 hour per year as part of a larger annual maintenance program over the life of the unit. The above present value formula was applied to every year of analysis cost, summed then adjusted by the appropriate climate zone. Table 189 is the average cost across all climate zones for all building prototypes (all building prototypes incur the same cost).

Results from the PV incremental maintenance cost analysis were factored into the Cost-Effectiveness analysis.

Table 189: Digital or Mechanical MMV 2026 PV\$ Incremental Maintenance Costs Over the Buildings Analysis Period (30 Years)

MF Building Type	Base Case Maintenance Material Cost	Base Case Maintenance Labor Cost	Proposed Maintenance Material Cost	Proposed Maintenance Labor Cost	Incremental Maintenance Cost
Low-Rise Garden Style	\$0	\$0	\$0	\$1,794	\$1,794
Low-Rise Loaded Corridor	\$0	\$0	\$0	\$1,794	\$1,794
Mid-Rise Mixed Use	\$0	\$0	\$0	\$1,794	\$1,794
High-Rise Mixed Use	\$0	\$0	\$0	\$1,794	\$1,794

The Statewide CASE Team determined by anecdotal means that replacement of MMVs would occur at an average of every fifteen years. This being the case The Statewide CASE Team developed the following tables to quantify the incremental costs associated with the replacement of the equipment. The Team assumed that material costs would be 80 percent of what the material costs are currently and that labor hours would increase 25 percent.

Table 190: Replacement Material and Labor Costs for Base Case

MF Building Type	Average Material Cost	Material Labor Hours	Labor Rate	Total Cost
Low-Rise Garden Style	\$0	0	0	\$0
Low-Rise Loaded Corridor	\$0	0	0	\$0
Mid-Rise Mixed Use	\$0	0	0	\$0
High-Rise Mixed Use	\$0	0	0	\$0

Table 191: Replacement Material and Labor Costs for Proposed Case

MF Building Type	Average Material Cost	Material Labor Hours	Labor Rate	Total Cost
Low-Rise Garden Style	\$1,810	10	\$100	\$2,810
Low-Rise Loaded Corridor	\$1,906	10	\$100	\$2,906
Mid-Rise Mixed Use	\$4,030	20.01	\$100	\$6,031
High-Rise Mixed Use	\$4,249	20.01	\$100	\$6,050

Table 192: Incremental Replacement Costs for Base Case vs Proposed Case

MF Building Type	Base Case	Proposed Case	Total Incremental Cost	Average Incremental Cost per Dwelling Unit
Low-Rise Garden Style	\$0	\$2,810	\$2,810	\$351
Low-Rise Loaded Corridor	\$0	\$2,906	\$2,906	\$81
Mid-Rise Mixed Use	\$0	\$6,031	\$6,031	\$69
High-Rise Mixed Use	\$0	\$6,050	\$6,050	\$52

6.4.5 Cost-Effectiveness

This measure proposes a prescriptive requirement. As such, a cost analysis is required to demonstrate that the measure is cost effective over the 30-year period of analysis.

The CEC establishes the procedures for calculating Cost-Effectiveness. The Statewide CASE Team collaborated with CEC staff to confirm that the methodology in this report is consistent with their guidelines, including which costs were included in the analysis. The incremental first cost and incremental maintenance costs over the 30-year period of analysis were included. The LSC savings from electricity and natural gas were also included in the evaluation. Design costs were not included nor were the incremental costs of code compliance verification.

According to the CEC's definitions, a measure is cost effective if the B/C ratio is greater than 1.0. The B/C ratio is calculated by dividing the cost benefits realized over 30 years by the total incremental costs, which includes maintenance costs for 30 years. The B/C ratio was calculated using 2026 PV costs and cost savings.

Results of the per-unit, cost-effectiveness analyses are presented in Table 193 and Table 194 for new construction buildings. Benefits and costs are defined as follows:

- **Benefits: 30-year LSC Savings + Other PV Savings:** Benefits include LSC savings over the 30-year period of analysis (California Energy Commission 2022). Other savings are discounted at a real (nominal – inflation) three percent rate. Other PV savings include incremental first-cost savings if proposed first cost is less than current first cost, incremental PV maintenance cost savings if PV of proposed maintenance costs is less than PV of current maintenance costs, and incremental residual value if proposed residual value is greater than current residual value at end of CASE analysis period.
- **Costs: Total Incremental Present Valued Costs:** Costs include incremental equipment, replacement, and maintenance costs over the period of analysis if PV of proposed costs is greater than PV of current costs. Costs are discounted at a real (inflation-adjusted) three percent rate. If incremental maintenance cost is negative, it is treated as a positive benefit. If there are no total incremental PV costs, the B/C ratio is infinite.

Table 193: 30-Year Cost-Effectiveness Summary Per Dwelling Units – New Construction/Additions – Prescriptive HPWH - Master Mixing Valve

Climate Zone	Benefits 30-year LSC Savings + Other PV Cost Savings (2026 PV\$/dwelling unit)	Costs Total Incremental PV Costs (2026 PV\$/dwelling unit)	B/C Ratio
1	\$3,400	\$155	22
2	\$3,068	\$170	18
3	\$3,066	\$167	18
4	\$3,172	\$173	18
5	\$2,957	\$176	17
6	\$2,448	\$160	15
7	\$2,792	\$163	17
8	\$2,801	\$158	18
9	\$2,740	\$157	17
10	\$2,858	\$159	18
11	\$3,367	\$160	21
12	\$3,149	\$164	19
13	\$3,294	\$164	20
14	\$3,007	\$154	19
15	\$2,954	\$154	19
16	\$3,245	\$156	21

Table 194: 30-Year Cost-Effectiveness Summary Per Dwelling Units – New Construction/Additions – Prescriptive Gas - Master Mixing Valve

Climate Zone	Benefits 30-year LSC Savings + Other PV Cost Savings (2026 PV\$/dwelling unit)	Costs Total Incremental PV Costs (2026 PV\$/dwelling unit)	B/C Ratio
1	\$1,768	\$143	12
2	\$1,632	\$157	10
3	\$1,597	\$154	10
4	\$1,551	\$160	10
5	\$1,593	\$162	10
6	\$1,451	\$148	10
7	\$1,420	\$150	9
8	\$1,403	\$146	10
9	\$1,417	\$145	10
10	\$1,339	\$147	9
11	\$1,409	\$147	10
12	\$1,477	\$152	10
13	\$1,384	\$152	9
14	\$1,415	\$143	10
15	\$1,135	\$143	8
16	\$2,046	\$144	14

6.5 Annual Statewide Impacts

6.5.1 Statewide Energy and Energy Cost Savings

The Statewide CASE Team calculated the first-year statewide savings for new construction and additions by multiplying the per-unit savings, which are presented in Section 6.3.2, by assumptions about the percentage of newly constructed buildings that would be impacted by the proposed code. The statewide new construction forecast for 2026 is presented in Appendix A, as are the Statewide CASE Team's assumptions about the percentage of new construction that would be impacted by the proposal (by climate zone and building type).

The first-year energy impacts represent the first-year annual savings from all buildings that were completed in 2026. The 30-year energy cost savings represent the energy cost savings over the entire 30-year analysis period. The statewide savings estimates do not take naturally occurring market adoption or compliance rates into account.

Table 195 presents the first-year statewide energy and energy cost savings from newly constructed buildings for the proposed prescriptive option by climate zone. While a statewide analysis is crucial to understanding broader effects of code change proposals, there is potential to disproportionately impact DIPs that needs to be considered. Refer to Section 6.6 for more details addressing energy equity and environmental justice.

Table 195: Statewide Energy and Energy Cost Impacts – New Construction and Additions – Master Mixing Valve

Climate Zone	Statewide New Construction & Additions Impacted by Proposed Change in 2026 Dwelling Units	Annual ^a Electricity Savings (GWh)	Annual Peak Electrical Demand Reduction (MW)	Annual Natural Gas Savings (Million Therms)	Annual Source Energy Savings (Million kBtu)	30-Year Present Valued LSC Savings (Million 2026 PV\$)
1	96	0.002	0.001	0.001	0.097	\$0.20
2	923	0.019	0.01	0.009	0.871	\$1.73
3	5,110	0.104	0.057	0.05	4.751	\$9.45
4	2,268	0.045	0.028	0.021	2.023	\$4.15
5	189	0.004	0.002	0.002	0.176	\$0.35
6	1,489	0.027	0.014	0.013	1.262	\$2.41
7	3,422	0.06	0.032	0.03	2.826	\$5.66
8	5,708	0.098	0.057	0.049	4.659	\$9.37
9	6,837	0.119	0.07	0.059	5.619	\$11.24
10	2,858	0.049	0.03	0.023	2.204	\$4.57
11	779	0.014	0.009	0.006	0.623	\$1.36
12	3,675	0.071	0.042	0.032	3.113	\$6.48
13	670	0.012	0.008	0.006	0.529	\$1.15
14	960	0.018	0.011	0.008	0.768	\$1.62
15	248	0.003	0.003	0.002	0.159	\$0.36
16	124	0.003	0.001	0.001	0.118	\$0.28
Total	35,354	0.65	0.38	0.31	29.8	\$60.40

a. First-year savings from all buildings completed statewide in 2026.

6.5.2 Statewide GHG Emissions Reductions

The Statewide CASE Team calculated avoided GHG emissions associated with energy consumption using the hourly GHG emissions factors that the CEC developed along with the 2025 LSC hourly factors and an assumed cost of \$123.15 per metric tons of carbon dioxide equivalent emissions metric tons CO₂e.

The 2025 monetary value of avoided GHG emissions is based on a proxy for permit costs (not social costs).⁶⁷ The cost-effectiveness analysis presented in Section 6.4.2 of

⁶⁷ The permit cost of carbon is equivalent to the market value of a unit of GHG emissions in the California Cap-and-Trade program, while social cost of carbon is an estimate of the total economic value of damage done per unit of GHG emissions. Social costs tend to be greater than permit costs. See more on the Cap-and-Trade Program on the California Air Resources Board website: <https://ww2.arb.ca.gov/our-work/programs/cap-and-trade-program>.

this report does not include the cost savings from avoided GHG emissions. To demonstrate the cost savings of avoided GHG emissions, the Statewide CASE Team disaggregated the value of avoided GHG emissions from the other economic impacts.

Table 196 presents the estimated first-year avoided GHG emissions of the proposed prescriptive code measure. During the first year, GHG emissions of 2,468 metric tons CO2e would be avoided.

Table 196: Annual Statewide GHG Emissions Impacts - Master Mixing Valve

Measure	Electricity Savings ^a (GWh/yr)	Reduced GHG Emissions from Electricity Savings ^a (Metric Tons CO2e)	Natural Gas Savings ^a (Million Therms/yr)	Reduced GHG Emissions from Natural Gas Savings ^a (Metric Tons CO2e)	Total Reduced GHG Emissions ^b (Metric Ton CO2e)	Total Monetary Value of Reduced GHG Emissions ^c (\$)
MMV	0.65	299	0.31	2,169	2,468	\$303,881

- First-year savings from all applicable newly constructed buildings, additions, and alterations completed statewide in 2026.
- GHG emissions were calculated using hourly GHG emissions factors published alongside the LSC hourly factors published by the CEC here: <https://www.energy.ca.gov/files/2025-energy-code-hourly-factors>
- The monetary value of avoided GHG emissions is based on a proxy for permit costs (not social costs) derived from the 2022 TDV UpMa

6.5.3 Statewide Water Use Impacts

The proposed code change would not result in water savings.

6.5.4 Statewide Material Impacts

Based on the proposed code change, the impact on material is analyzed for this measure and resulted in increased consumption for Lead and Copper. See Appendix D for more details.

Table 197: Annual Statewide Impacts on Material Use – Master Mixing Valves

Material	Impact	Per-Unit Impacts (Pounds per Square Foot)	Annual ^a Statewide Impacts (Pounds)
Lead	Increase	0.002033	108
Copper	Increase	1.24333	66,228
TOTAL	-	-	-

- First-year savings from all buildings completed statewide in 2026.

6.5.5 Other Non-Energy Impacts

MMV non-energy impacts include health and safety benefits by reducing the scalding and pathogen risks to the dwelling unit occupants.

6.6 Addressing Energy Equity and Environmental Justice

The Statewide CASE Team assessed the potential impacts of the proposed measure on DIPs. See Section 2 for a summary of research methods and potentially impacted populations, as well as other general potential equity impacts (DC Fiscal Policy Institute 2017) (CALEPA 2022).

6.6.1 Potential Impacts

This measure would result in higher construction costs, a reduction in energy costs, and improved hot water delivery, which are discussed in detail in Section 2.2.2, with impacts on potentially impacted populations as described in Section 2.2.1.

6.6.1.1 Job Creation

These two measures may create more installation and commissioning jobs for plumbers.

7. Central HPWH Clean-up

7.1 Measure Description

7.1.1 Proposed Code Change

This measure would include the following prescriptive requirement for new construction multifamily buildings:

- Revise the existing prescriptive requirement to use single-pass HPWH as the primary HPWH equipment in DHW plant design, remove primary storage tank plumbing configuration requirement to allow design flexibility, and clean-up recirculation loop tank heater requirements.
- Add alternative prescriptive pathway leveraging NEEA's Advanced Water Heating Specification V8.0 for commercial HPWH system to allow design flexibility, ensure system efficiency, and provide reliability using the prescriptive pathway. The alternative prescriptive requirement would require HPWH systems meeting NEEA AWHS V8.0 Tier 2.

This measure would not modify the standard central HPWH model in the compliance software.

7.1.2 Justification and Background Information

7.1.2.1 Justification

With federal, state, local, and utility incentive programs, and a cultural drive towards reducing carbon emissions, the market for HPWHs in California has increased significantly over the last few years. Water heating accounts for 40 percent of natural gas consumption in the residential sector, representing 7 percent of the state's total GHG emissions (E3 2019). Water heating energy use in multifamily buildings can account for 27 to 32 percent of total energy use based on 2015 Residential Energy Consumption Survey by U.S. EIA. In 2022, Governor Gavin Newsom announced plans to expand California's climate change programs through the California Air Resources Board (CARB) and the CEC, with goals to install six million heat pumps (including HPWHs) by 2030 (Newsom 2022).

HPWH systems use electricity to produce hot water by transferring heat energy from one source, typically air, to potable water. This process can be two to three times more energy efficient than a fossil/gas or electric-resistance water heating system.

The 2022 Title 24 Statewide All-Electric CASE research suggested central DHW systems are common in most multifamily buildings, except for those with a small

number of dwelling units. Central HPWH systems are an important technology to decarbonize multifamily buildings.

2022 Title 24, Section 170.2 (d)2 already provides the alternative pathway for central HPWH systems, but the variety of system and configurations capable of being modeled were limited when the Statewide CASE Team developed the 2022 code requirements in 2019. Since 2019, the central HPWH technology and applications have evolved significantly. With state regulations and local mandates moving to decarbonize buildings, many state and federal sponsored efforts have recently made performance data available to support evaluation of a wider range of system and configurations, incentivized manufacturers to improve product availability and reliability, and created awareness and knowledge of the technology amount the design communities and building owners including:

- Industry adoption of the central HPWH technology increased significantly in the past three years, and manufacturers have increased product offering and improved market delivery approach.
- National and regional efforts to advance knowledge of the technology, including the CEC-funded EPIC research program, U.S. DOE funded programs, NEEA's effort to expand advanced water heating specifications to commercial HPWH, and the Advanced Water Heating Initiative, led by the New Buildings Institute.
- Lab-testing results of central HPWH equipment and system configurations funded by investor-owned utilities become available.

The proposed language provides projects with a variety of efficient configurations for central HPWH plant designs, including single pass primary with swing tank, single pass primary with multi-pass secondary, single pass return to primary, and multi-pass return to primary. The proposal provides a prescriptive pathway for potentially a wide range of configuration of the central HPWH system design supported by HPWH manufacturers. Contractors can select heat pump water heater systems that meet the configuration requirement in the proposed code language.

The proposal is based largely on the requirements listed in Section 170.2(d)2 of the 2022 Title 24 code.

7.1.2.2 Background Information

Under the 2019 Title 24, the CEC provided an Executive Director Determination Pursuant to Section 150.1 (c)8C that allows central HPWH systems that meet specified design and installation criteria to show compliance with 2019 Title 24, Part 6 under the prescriptive path (California Energy Commission 2019). For the 2022 code cycle, the Statewide CASE Team developed an alternate compliance pathway for central HPWH systems. The 2022 Title 24 code requires the Standard Design be a central HPWH

system if the Proposed Design uses central electric water heating and a gas central water heater if the Proposed Design uses natural gas. The 2022 code requirements establish a foundational structure for future code improvement.

The 2022 prescriptive requirements include basic equipment, plumbing, control, and design documentation requirements to ensure minimum performance of the system. Building on the existing requirements, this measure proposal would investigate providing prescriptive pathway(s) for additional central HPWH plant design and control approaches.

The 2022 code includes JA 14, which provides qualification requirements for a performance pathway for central HPWH systems. JA14 includes product performance testing requirements, as well as plumbing, control, and design documentation requirements. The initial 2022 code proposal included establishing minimum efficiency requirements for central HPWH as part of the prescriptive requirement. However, the product data and interview results revealed that a big barrier to requiring minimum efficiency is the lack of a standardized testing method and a performance rating metric. With the performance data requirement by JA14 under the 2022 code, the Statewide CASE Team proposed to revisit the proposal to establish a minimum system level efficiency requirement for central HPWH design. NEEA developed a widely referenced Advance Water Heating Specification (AWHS) that originally only covered residential HPWHs, and they are currently developing their AWHS 8.0 to include multifamily central HPWH products (NEEA 2022). The specification includes commercial system efficiency calculation and requirements that consider performance of connected water heating, the primary plant, and temperature maintenance equipment. The Statewide CASE Team would leverage the NEEA AWHS 8.0 for code development of efficiency requirement.

7.1.3 Summary of Proposed Changes to Code Documents

The sections below summarize how the standards, Reference Appendices, ACM Reference Manuals, and compliance forms would be modified by the proposed change.⁶⁸ See Section 11 of this report for detailed proposed revisions to code language.

7.1.3.1 Specific Purpose and Necessity of Proposed Code Changes

Each proposed change to language in Title 24, Part 1 and Part 6 as well as the reference appendices to Part 6 are described below. See Section 11.2 of this report for marked-up code language.

⁶⁸ Visit EnergyCodeAce.com for trainings, tools and resources to help people understand existing code requirements.

Section: Section 170.2(d)2

Specific Purpose: The specific purpose is to update the existing prescriptive requirement for central HPWH systems to ensure minimum efficiency requirements. In addition, to add an alternative performance compliance pathway to leverage NEEA AWH 8.0 and provide paths that feature a variety of central HPWH systems and configurations with minimum efficiency requirements.

Necessity: These changes are necessary to increase building energy efficiency via cost-effective building design standards, as mandated by California Public Resources Code, Section 25213 and 25402

7.1.3.2 Specific Purpose and Necessity of Changes to the Nonresidential and Multifamily ACM Reference Manual

The purpose and necessity of proposed changes to the Nonresidential and Multifamily ACM Reference Manual are described below. See Section 11.411.4 of this report for the detailed proposed revisions to the text of the ACM Reference Manual.

Section: Section 6.12.3

Specific Purpose: The proposed measure does not require changes to ACM reference manual.

Necessity: n/a

7.1.3.3 Summary of Changes to the Nonresidential and Multifamily Compliance Manual

Chapter 11 of the Nonresidential and Multifamily Compliance Manual would need to be revised.

- Description of the variety of central HPWH system configurations and impacts of energy performance.
- Description of system efficiency calculation approach

Section: Section 11.6

Specific Purpose: The specific purpose is to modify the contents associated with the central HPWH to make it consistent with code changes.

Necessity: These changes are necessary to increase building energy efficiency vs. cost-effective building design standards.

7.1.3.4 Summary of Changes to Compliance Forms

The proposed code change would modify the compliance forms listed below. Examples of the revised forms are presented in Section 11.5.

- 2022-LMCC-PLB-E: Low-Rise Multifamily Certificate of Compliance Domestic Water Heating:
 - Update primary central HPWH prescriptive requirement per proposed code change.
 - Adds an alternative prescriptive option for central HPWH whether the selected system product is on the NEEA AWHS Tier 2 qualified product list.
- 2022-NRCC-PLB-E: Nonresidential Certificate of Compliance Domestic Water Heating:
 - Update primary central HPWH prescriptive requirement per proposed code change.
 - Adds an alternative prescriptive option for central HPWH whether the selected system product is on the NEEA AWHS Tier 2 qualified product list.
- 2022-LMCI-PLB-E: Low-Rise Multifamily Certificate of Inspection Domestic Water Heating:
 - Update primary central HPWH prescriptive requirement per proposed code change.
 - Adds an alternative prescriptive option for central HPWH whether the selected system product is on the NEEA AWHS Tier 2 qualified product list.
- 2022-NRCI-PLB-E: Nonresidential Certificate of Inspection Domestic Water Heating:
 - Update primary central HPWH prescriptive requirement per proposed code change.
 - Adds an alternative prescriptive option for central HPWH whether the selected system product is on the NEEA AWHS Tier 2 qualified product list.

7.1.4 Regulatory Context

7.1.4.1 Determination of Inconsistency or Incompatibility with Existing State Laws and Regulations

The 2022 Title 24 includes an alternate compliance pathway for central HPWH systems serving multiple dwelling units. The prescriptive requirements include basic equipment,

plumbing, control, and design documentation requirements to ensure the minimum performance of the system.

This proposal is not relevant to other parts of the California Energy Code (<https://www.dgs.ca.gov/BSC/Codes>). Changes outside of Title 24, Part 6 are not needed.

As of January 2023, 69 local jurisdictions have adopted local ordinances that encourage or require the use of electric water heating in residential and/or nonresidential applications (Gable 2021). The Statewide CASE Team has not identified inconsistency or incompatibility with any reach code.

7.1.4.2 Duplication or Conflicts with Federal Laws and Regulations

There is no federal efficiency standard for commercial HPWHs, which are commonly used in central HPWH system design. The U.S. DOE defines commercial HPWH as a water heater (including all ancillary equipment such as fans, blowers, pumps, storage tanks, piping, and controls, as applicable) that uses a refrigeration cycle, such as vapor compression, to transfer heat from a low-temperature source to a higher-temperature sink for the purpose of heating potable water, and it has a rated electric power input greater than 12 kW (10 CFR § 431.102 2022).

7.1.4.3 Difference From Existing Model Codes and Industry Standards

There are no relevant requirements for central HPWH in national model codes, such as the International Energy Conservation Code (IECC) and the ASHRAE Standard 90.1 and ASHRAE 189.1 or voluntary rating systems, such as Leadership in Energy and Environmental Design.

There are several industry standards and voluntary rating systems for HPWH testing procedure:

- Commercial HPWHs, having a rated electric power input greater than 12 KW (10 CFR § 431.102 2022), can be rated according to Code of Federal Regulation (CFR) Title 10 Appendix E to Subpart G of Part 431.106—Uniform Test Method for the Measurement of Energy Efficiency of Commercial Heat Pump Water Heaters (10 CFR § 431.106 2022), but there is not an associated minimum efficiency standard for commercial size HPWHs suitable for multifamily building applications⁶⁹. Responses from manufacturer interviews indicated that the federal test procedure does not reflect operating conditions of central HPWH systems, and the manufacturers were either not aware of it or did not test to these conditions and procedures.

⁶⁹ U.S. DOE has a test procedure and efficiency standards for HPWHs with rated storage volume less than 120 gallons.

- Commercial HPWHs can be rated according to ANSI/AHRI Standard 1301 Performance Rating of Commercial Heat Pump Water Heaters.
- Commercial HPWHs can be rated according to the AWHs 8.0 (NEEA 2022). AWHs 8.0 provides qualified piping configurations for central HPWH systems, based on the recommendations of manufacturers. EcoSim is a commercial HPWH system modeling software, created by Ecotope, which simulates one year of HPWH system operation on a minute-by-minute basis to predict an average annual system coefficient of performance (SysCOP). EcoSim provides an annual simulation for every combination of qualified piping configurations specified in NEEA AWHs 8.0, 16 IECC climate zones relevant to the United States, and four different multifamily building prototypes. AWHs administrators utilized the estimated annual SysCOP predicted by EcoSim to define the commercial HPWH system efficiency tiers. NEEA developed the commercial multifamily HPWH qualified products list (NEEA 2022), which specifies the list of certified commercial HPWH products, according to the AWHs 8.0.
- ENERGY STAR® rating system refers to the commercial HPWH definition from 10 CFR § 431.102, with the certification criteria requiring the coefficient of performance (COP) of the commercial HPWH being equal or larger than 3.0. The testing method also follows the 10 CFR Part 431.106, Subpart G, Appendix E (Energy Star 2018).
- AHRI is developing AHRI Standard 1430P. This is an analogous standard for residential electric resistance and HPWHs, but with a broader objective to establish a more comprehensive standard and to consolidate various patchwork requirements within the industry for water heaters. The timeline for the standard is unknown.

However, most of the HPWH manufacturers interviewed by the Statewide CASE Team suggested that there is no clear CFR classification for the HPWH products most relevant to this proposal, and most manufacturers test their products using an in-house procedure that is not publicly available.

The Statewide CASE Team leveraged the NEEA AWHs 8.0 for code development of efficiency requirements.

7.1.5 Compliance and Enforcement

When developing this proposal, the Statewide CASE Team considered methods to streamline the compliance and enforcement process and how negative impacts on market actors who are involved in the process could be mitigated or reduced. This section describes how to comply with the proposed code change. It also describes the compliance verification process. Section 7.2 presents how the proposed changes could impact various market actors.

The compliance verification activities related to this measure that need to occur during each phase of the project are described below:

- **Design Phase:** Design engineers (generally plumbing engineers) specify HPWH equipment and recirculation system design according to engineering analysis and manufacturer guidelines. Designers specify the equipment footprint, clearance requirements, and structural support needed for large storage tanks. This practice is similar to current practice for conventional gas-fired water heater systems, and it would require coordination among different trades in the design team. The design drawings show additional design features and details for ventilation requirements and condensate pipe. They would also need to coordinate with electrical designers for electrical sizing. When performance compliance is used, design engineers provide modeling inputs for the central HPWH system in the compliance software and information on system designs and features on the certificate of compliance documents. Activities designers would perform associated with the proposed code change include:
 - Decide central HPWH system configurations for the projects. They should consider energy performance, cost, space requirements, and equipment location for making the decision. The plumbing engineer would perform the same task when designing gas or central HPWH systems, but with added modeling capability to compliance software, plumbing engineers would be able to make more informed decisions for a wider range of configurations.
 - Work with energy consultants to ensure the proposed design meets minimum efficiency.
- **Permit Application Phase:** Plan examiners perform plan check reviews on equipment location, check recirculation system design, and verify that the building adheres to the performance budget or is designed according to prescriptive standards. Plans examiners would check for system efficiency in addition to required designed features such as equipment location, loop counts, and lengths and diameters, and they would ensure that all meet code requirements. Specific changes the plan examiners should check related to the proposed code change include:
 - If the project uses the primary central HPWH prescriptive pathway, the equipment selection and plumbing configurations should meet the updated requirement per proposed code change.
 - If the project uses the alternative prescriptive option for central HPWH, the selected system product is on the NEEA AWHS Tier 2 qualified product list.

- **Construction Phase:** Plumbing contractors install the central HPWH system including the heat pump, storage tanks, plumbing components, and specialties including mixing valves and control sensors—as designed and per manufacturer instructions. Electrical contractors install electrical services as design. After installation, either a design engineering team member or a contracted third party would confirm space requirements and perform necessary commissioning testing to ensure the system and controls are installed and function as designed.
- **Inspection Phase:** Plumbing contractors populate LMCI/NRCI forms and schedule on-site verifications. HERS Raters or ATTs perform on-site verification to ensure that the equipment, system design, piping configurations, and controls are in alignment with submitted plans and code requirements. HERS Raters or ATTs submit LMCV/NRCV forms accordingly.

Due to the increased intricacies and complexities of HPWHs compared to gas-fired systems, the compliance process for central HPWH systems requires a higher degree of design engineer and energy consultant coordination during the design phase, closer contractor adherence to the design details during bid and installation, and continued oversight from design engineers throughout and after installation, compared to a similar gas-fired system.

7.2 Market Analysis

7.2.1 Current Market Structure

The Statewide CASE Team performed a market analysis with the goals of identifying current technology availability, current product availability, and market trends. It then considered how the proposed standard may impact the market in general as well as individual market actors. Information was gathered about the incremental cost of complying with the proposed measure. Estimates of market size and measure applicability were identified through research and outreach with stakeholders including utility program staff, CEC staff, and a wide range of industry actors. In addition to conducting personalized outreach, the Statewide CASE Team discussed the current market structure and potential market barriers during a public stakeholder meeting(s) that the Statewide CASE Team held on February 24, 2023. Add presentation and notes to the bibliography and add an in-text citation to referenced material.

The main market actors include building owners/developers, design engineers, architects, contractors, equipment manufacturers, and energy consultants.

- **Building owners/developers:** Owners and developers are the ultimate decision-makers on the type of systems that go into their buildings. For an emerging technology like central HPWH system to become widely adopted, owners and developers must become acquainted with it and feel confident that the systems

would perform to make the investment. Currently, developers work alongside designers to determine whether HPWHs are an option for their designs.

- **Design engineers and consultants:** Design engineers (generally plumbing engineers) and consultants are responsible for designing plumbing systems, including central HPWH. Once the HPWH option passes through concept design stage, designers work directly with select manufacturers to design the system and specify equipment. In addition to technical design aspects, designers must consider a myriad of site and project details. Site-level needs include building electrical upgrades, physical space for hosting storage tanks, and space and location to provide adequate ventilation. Plumbing designers need to coordinate with other trades such as electrical engineers to meet such needs. Designers and installation contractors must also collaborate to meet permitting and compliance requirements and balance performance and budget objectives. As of December 2022, 69 local jurisdictions have adopted local ordinances that encourage or require the use of electric water heating in residential and/or nonresidential applications. These professionals need to follow reach code requirements and would need to learn how energy-efficient and cost-effective design of central HPWH systems differs from that of traditional, gas-fired DHW systems.
- **Architects:** Architects design the buildings and plan for the spaces where central HPWH systems are installed. Decisions made by architects on the size and location of mechanical/plumbing areas, as well as other aspects of building layout, can significantly impact the feasibility of central HPWH systems. For example, insufficient space for central HPWH storage tanks would mean the system would need more heat pumps, increasing system cost. Locating the hot water system on the roof, versus on the ground floor, may require increased structural requirements to support large storage tanks. Insufficient compressor ventilation air would decrease the performance of the central HPWH system, lowering the energy saving and Cost-Effectiveness. Other considerations include room and building acoustics.
- **Manufacturers:** Equipment manufacturers develop, market, and sell central HPWH equipment. For central HPWH to be widely adopted, these companies would need to increase production, California distribution, and support for central HPWH equipment.
- **Distributors and Manufacturers Representatives:** Distributors and manufacturer representatives (reps) provide design, installation, and commissioning assistance for a manufacturer's equipment line. These reps are usually limited in scope to the products they carry. They would need to increase their familiarity with the considerations of central HPWH systems to support wider adoption of these systems.

- **Contractors:** Central HPWH equipment is usually installed by the plumbing contractor, with some coordination by a general contractor with other trades such as electricians and mechanical contractors. When ducting is required for ventilation, mechanical contractors would need to be involved to install ductwork and associated mechanical equipment such as fans and louvers. After installation, depending on the type of work, maintenance and repairs of central HPWH equipment may need to be performed by a mechanical contractor or other licensed professionals to work with refrigerant-containing components.
- **Energy Consultants:** Energy consultants both complete energy code-compliance modeling and advise design teams on improved design approaches. These professionals would need to learn how the design and modeling of central HPWH systems is different from gas systems, so they can appropriately advise design teams and accurately model the systems for code compliance. Note that there are current local reach codes that already require all electric construction, and energy consultants need to be aware of the compliance options for electric systems.

In addition to traditional market actors, because central HPWH is a growing market, state and local government agencies with regulatory and program activities play an important role in the direction, pace, and rules around central HPWH's adoption. These market actors and their activities are listed below.

- a. **IOUs:** The Statewide CASE Team is funding the lab-testing of central HPWH equipment to help the CEC develop performance curves and algorithms to accurately model the performance of central HPWH equipment. IOUs also provide educational classes at venues such as the PG&E Pacific Energy Center in San Francisco and the SCE Energy Education Center in Irwindale. These education centers, along with online educational resources, are critical to ensuring all market actors have access to training on best practices and approaches to central HPWH systems.
- b. **Program implementers: Community choice aggregators and municipal utilities** have been some of the earliest actors to create incentives and programs to assist developers in design and installation of central HPWH systems. Entities include SMUD, East Bay Community Energy, and regional energy networks offer ratepayer-funded incentives for central HPWH retrofit projects that involve fuel substitution, subject to the CPUC's Fuel Substitution Test. Other entities, such as the Bay Area Air Quality Management District and South Coast Air Quality Management District are creating programs offering non-ratepayer funded incentives for replacing gas equipment with heat pump technology, including central HPWH, to reduce local air pollution.
- c. **Researchers:** Research groups are studying the design and performance aspects of central HPWH systems and are helping to inform new industry standards and

best practices for design and operation of these systems. Examples of such groups are:

- NEEA, who developed the AWHs 8.0 for commercial/multifamily water heating systems.
 - CEC-funded EPIC research program, including:
 - i. Grant Funding Opportunity 15-308, led by Build It Green (Franklin Energy), studying design and implementation of central HPWH systems in affordable multifamily buildings; and
 - ii. EPIC 19-030 project led by the Association for Energy Affordability (AEA) to install and test the performance of low-global warming potential (GWP) central heat pump water heating systems at five multifamily buildings located in disadvantaged or low-income communities. The project would develop design configurations for easier adoption, provide best practices to ensure continued performance, and educate the design community to promote confidence in this emerging technology. The project is slated to wrap up by the end of 2023 (California Energy Commission 2023).
 - NEEA and PG&E funded lab testing of various central HPWH design options and ventilation strategies. The PG&E funded central HPWH equipment lab-testing would help the CEC develop performance curves and algorithms to accurately model the performance of central HPWH equipment. This research and updated modeling work would guide central HPWH Plant measure development in the 2025 code cycle.
- d. **State regulatory agencies:** State regulatory agencies like the CEC and CPUC create and maintain the rules that govern the installation and incentives for central HPWH systems. New and updated policies from these agencies, such as the CPUC's revision of the Three-Prong Test to the Fuel Substitution Test, have the potential to help move the market in the direction of energy-efficient, low-carbon systems like central HPWH.
- e. **Local governments:** Local governments in jurisdictions such as the Cities of San Jose, Berkeley, San Luis Obispo, and Carlsbad have passed electric-favoring reach codes, and some local jurisdictions such as Alameda, Cupertino, and Palo Alto have been developing all-electric reach codes and/or gas bans for new construction that would accelerate the adoption of central HPWH systems. Some local governments are executing public awareness and industry education campaigns to make people in their community more aware of and comfortable with central HPWH and other all-electric technologies.

7.2.2 Technical Feasibility and Market Availability

Three types of HPWH system designs are viable for implementation in multifamily buildings: individual, central, and clustered. Central and clustered designs both have HPWH equipment serving multiple dwelling units. For this study, the Statewide CASE Team defined *clustered* systems as HPWH designs that serve between two to eight dwelling units each with no recirculation system and identified *central* systems as designs that serve more than eight dwelling units and use a recirculation system. This definition is consistent with Title 24, Part 6 requirements. Most central HPWH systems use one water heating plant and distribution system for the entire building. However, a building may employ multiple central systems to serve the whole building. For example, a building might have one central system per floor, each with its own distribution and recirculation network. For this measure, the Statewide CASE Team is considering the central HPWH systems, not the clustered systems.

The Statewide CASE Team primarily used the following approaches to gather information about the current state of market and technical feasibility:

- Interview designers, contractors, and manufacturers
- Review design drawings and compliance forms from utility programs database, HERS providers, and design consultants
- Leverage lab testing data of central HPWH equipment and system configurations funded by PG&E to evaluate central HPWH design options. The lab-testing provides insights into the performance of central HPWH configurations under different load and operating conditions.
- Investigate field performance data from monitored real-world projects provided by Ecotope.

The Statewide CASE Team compiled a list of recently constructed multifamily buildings with HPWH systems to understand current HPWH design practice and the application trends. For project data, the Statewide CASE Team collected information from review of design drawings and specifications from various data sources, including utility programs Building Initiative for Low-Emissions Development Program (California Energy Commission 2020), Advanced Energy Build Program (Sonoma Clean Power 2020), California Multifamily New Homes program (Pacific Gas and Electric Company 2013), Dodge (Dodge Data & Analytics n.d.), EPIC Program (California Energy Commission n.d.), AEA (Association for Energy Affordability n.d.), SMUD (Sacramento Municipal Utility District n.d.), research demonstration projects, and the project database from PG&E's California Multifamily New Homes program. Note that this is a limited dataset, as most projects are in Northern California.

While this data does not represent a full market characterization, it does provide insight into current design decisions. The data shows that while individual systems are most

common in buildings up to three stories, central HPWH systems are more common in buildings three stories or taller. This finding is consistent with results reported in 2022 code cycle.

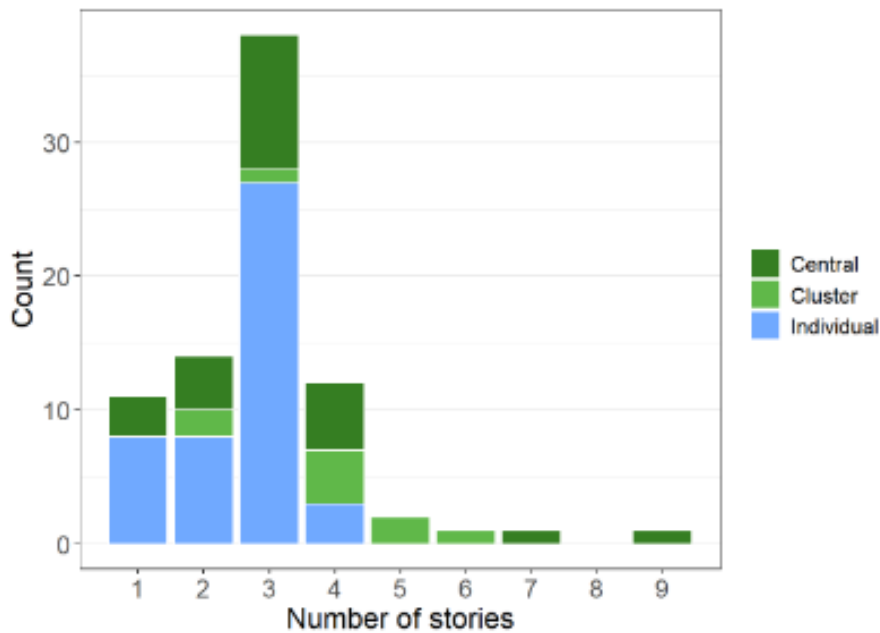

Figure 4: DHW distribution types of HPWH systems.

7.2.2.1 Equipment Features

Refrigerants

HPWHs use a range of refrigerant types, each with different thermodynamic properties, which impact their operation pressure, temperature requirements, and efficiency to move heat. This consequently impacts design and installation approaches such as the plumbing configuration, equipment location, and ventilation air quantity. The refrigerant can also dictate whether electric resistance backup, integrated or otherwise, is needed. A given refrigerant can achieve a certain heat transfer rate at an achievable pressure. If the heat transfer rate is insufficient under low outdoor temperatures or during certain draw periods (e.g., high total hot water usage), then electric resistance backup heating becomes necessary. The refrigerant likewise may be able to operate more efficiently at a higher pressure, negating the need for back up electric resistance; however, that pressure may not be achievable in the equipment's system. Therefore, the properties of the refrigerant play a big role in system design and capability.

Another metric used to differentiate refrigerants is GWP, which measures the GWP of the pollutant, as refrigerants are climate pollutants. CARB is proposing new regulations prohibiting use of high GWP refrigerants in a range of equipment types and end uses. As an example, the proposed regulation prohibits new stationary air-conditioning

equipment for residential and nonresidential end uses with refrigerants with a GWP of 750 or greater, effective January 1, 2023, (California Air Resources Board 2020). CARB's proposed regulations would drive technological development of low GWP refrigerant systems and impact central HPWH product availability, design considerations, and efficiency performance.

For the central HPWHs, currently the most used refrigerant by manufacturers is R-134a and R-410A. But the industry tends to move towards natural refrigerants when it is technically safe and available. CO₂ (R-744) has been a good candidate with a low GWP value of 1, which has a growing market in Asia, while propane (R-290), which has a GWP of 4, is under development and applied in small domestic applications in Europe. Both CO₂ and R-290 are well-suited for central HPWHs.

Based on review of existing HPWH product ⁷⁰, the Statewide CASE Team investigated the range of product performance data. The green bars in Figure 5 represent data within the upper and lower quartiles, while the lines indicate variability outside the upper and lower quartiles. And any point outside those lines or whiskers is considered as an outlier.

Figure 5 shows the relationship between refrigerant and minimal HPWH operating ambient air temperature, which indicates that R-744 has the lowest operating minimal ambient air temperature, followed by R-410A. In general, the R-134a minimal operating ambient air temperature is higher, around 30~40°F. Designers need to consider the minimum ambient air temperature the heat pump can operate in when deciding heat pump location and whether electric resistance back-up should be included. The annual system efficiency may decrease significantly when a heat pump with R-134a refrigerant is located outside, as it needs to engage electric resistance for a significant amount of time.

⁷⁰ Please note that the data points are limited due to the available product information.

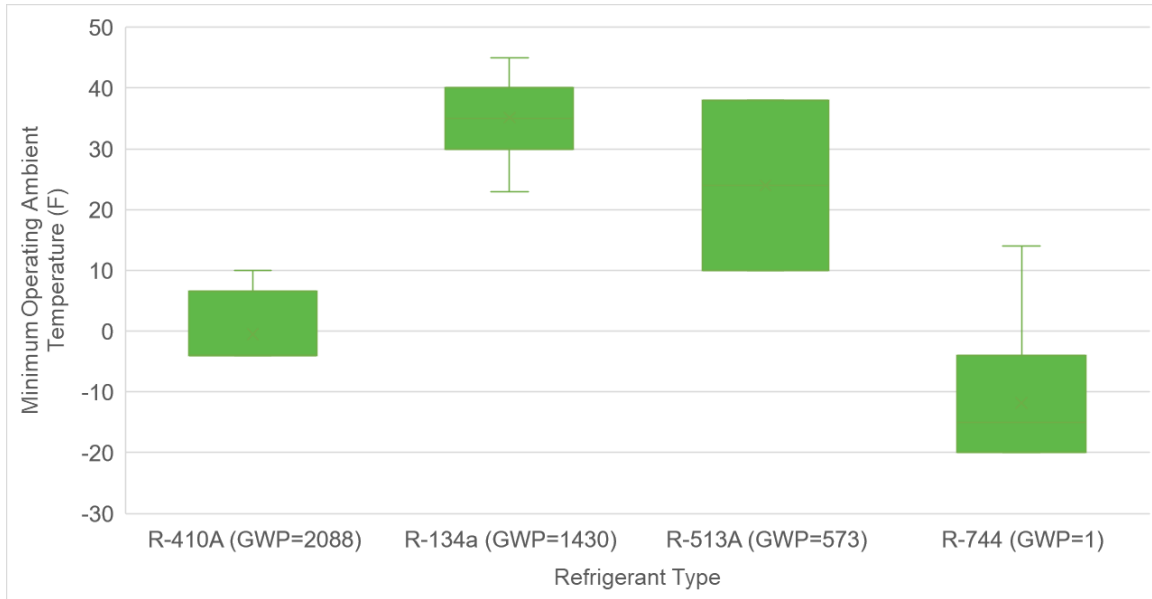

Figure 5: Refrigerant vs. minimal HPWH operating ambient air temperature.

Figure 6 shows the heat pump capacity ratio at ~40°F ambient air temperature, defined as the capacity at ~40°F over the capacity at ~70°F, which indicates that R-410A and R-744 have much higher minimal capacity ratios. The minimal capacity ratio for R-134a and R-513A are lower, indicating larger degradation when ambient air temperature drops to ~40°F. Designers need to consider the heat pump capacity ratio at ~40°F when deciding whether the heat pump can meet the hot water load (i.e., supply hot water at 120~140°F) when locating the heat pump outside. The capacity may drop significantly when a heat pump with R-134a refrigerant is located outside and cannot generate 120°F hot water and the ambient temperature drops to ~40°F.

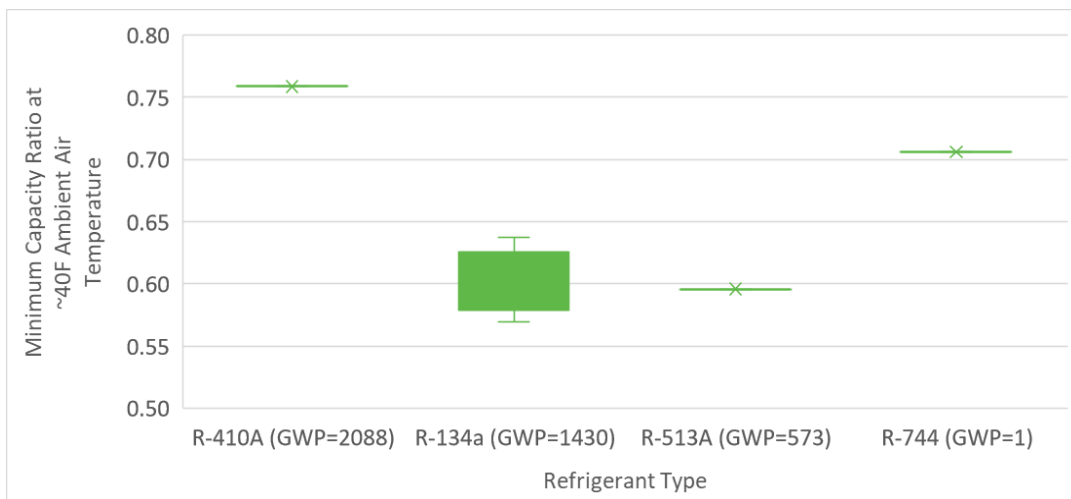

Figure 6: Heat pump heating capacity at ~40°F over capacity at ~70°F ambient air temperature for different refrigerants.

Figure 7 compares the HPWH heating COP at ~70°F with the COP at ~40°F, which shows that R-744 has the highest COP at ~70°F. For all refrigerants, the heating COP drops while the ambient air temperature decreases to ~40°F except R-410A. Designers need to consider the heat pump heating COP degradation with ambient temperature decreasing when deciding where to locate the heat pumps. The annual system efficiency may decrease significantly when a heat pump with R-134a refrigerant is located outside, as it needs to engage electric resistance for significant amount of time.

Please note that in Figure 6 and Figure 7, there is only one R-410A data point for heat pump capacity ratio at ~40°F and heating COP at ~70°F; therefore, the Statewide CASE Team may not be able to draw a reliable conclusion for it.

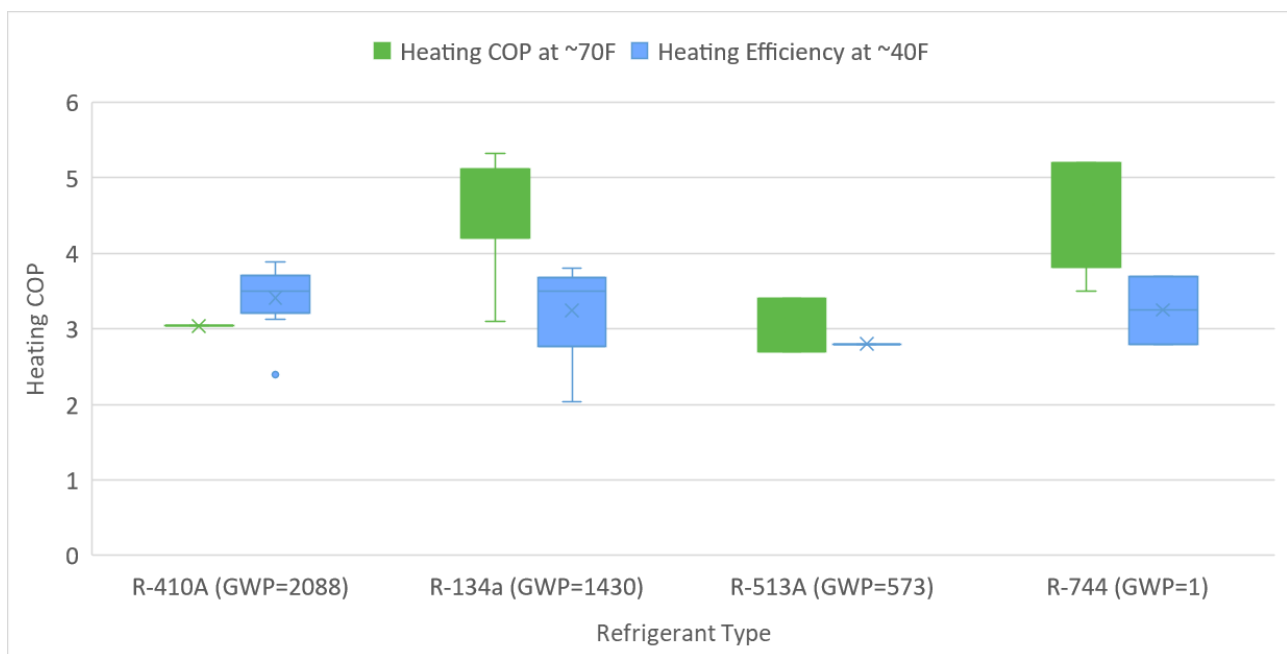

Figure 7: Heating COP at ~40°F ambient air temperature and at ~70°F ambient air temperature for different refrigerants.

Single-pass vs. Multi-pass

A key design feature of a central HPWH system is whether it has a single-pass or multi-pass piping configuration. In a single-pass HPWH system, the cold water passes through the heat pump(s) once and is heated to the intended storage temperature. In this type of system, the heat pump draws cold water from the bottom of the storage tank and delivers hot water to the top of the storage tank, resulting in a highly stratified tank. HPWH equipment that uses R744 requires single-pass configuration, since R744 requires a large (20°F+) water temperature increase through the heat pump. Some R134 and R410A systems can have single-pass configurations.

In a multi-pass HPWH system, the cold water passes through the heat pump(s) multiple times, each time gaining a 7-10°F temperature increase, until the tank reaches the intended storage temperature. In a multi-pass system, the heat pumps draw cold water from the bottom third of the storage tank and deliver hot water to just above where it is drawn. This piping configuration can still produce a stratified tank, but less so than in a single-pass configuration. HPWH equipment that uses R410A, R134a, and refrigerants other than R744 can have multi-pass configuration, since they can handle a small water temperature lift through the heat pump. Some R134a and R410A systems can have either single-pass or multi-pass configuration.

Some key differences between single-pass and multi-pass models are:

- With current HPWH product features, availability, and price points, single-pass models have higher reported COP values than multi-pass models.
- Most single-pass heat pumps do not operate well with warm incoming water temperatures (above approximately 110°F), while multi-pass systems performance does not degrade as much with warm incoming water temperature. This is a critical feature that impacts DHW system configuration. DHW systems typically supply water at 120-125°F and return water at 105-115°F. For single-pass heat pumps, integration with recirculation systems is a more complex and costly endeavor due to HPWH sensitivity to inlet water temperature. In contrast, multi-pass models integrated with the recirculation system better resemble the standard practice of gas-fired water heaters, which makes multi-pass models a more familiar and economic choice, albeit with a lower COP value.

Depending on the type of HPWH selected, designers must configure and control the plumbing system to ensure the HPWH operation stays in a favorable operation range.

7.2.2.2 System Plumbing Configurations

For HPWHs, many single-pass heat pumps do not operate well with warm incoming water temperatures (above approximately 110°F). A critical design feature of commercial HPWH systems with hot water circulation systems is to separate the two distinct building DHW loads: 1) primary water heating and 2) temperature maintenance of recirculating hot water due to heat loss in the distribution loop. In doing so, the DHW system design can prioritize delivering cool water to the HPWHs for peak performance while maintaining thermal stratification in the primary tanks. Separating primary heating load and temperature maintenance load can lessen heating equipment cycling and yield better system reliability. The drawbacks of having a decoupled temperature maintenance loop, as compared to having recirculation loop directly return to primary HPWH system, include increased plumbing and control complexity, space requirements, and associated costs. The energy efficiency of the overall system may

decrease or increase depending on equipment sizing strategy, control, and the efficiency of the distribution loop.

To separate the two loads, a key design practice is to use a temperature maintenance system separated from the thermally-stratified primary storage volume. A temperature maintenance system consists of a recirculation pump, a storage tank (the *loop tank*), and a temperature maintenance heat source. There are two different types of temperature maintenance systems: (1) a *swing tank* design, which uses a loop tank piped in series with the primary storage, illustrated in Figure 8, and (2) a *parallel loop tank* design, which uses a loop tank piped in parallel with the primary storage, illustrated in Figure 10.

For multi-pass heat pumps, there is little advantage having a decoupled temperature maintenance loop, because the heat pump equipment can handle warm incoming water temperatures with reasonable efficiency.

To summarize, the Statewide CASE Team investigated a wide range of plumbing configurations consistent with four of the seven qualified piping configurations listed in AWHs 8.0 (NEEA 2022):

- Single-pass primary with electric resistance water heater in series for temperature maintenance system (HPWH_SPST) (Figure 8). This configuration aligns with the 2022 Title 24 prescriptive requirements.
- Single-pass return to primary (HPWH_SPRetP) (Figure 9)
- Single-pass primary with multi-pass in parallel for temperature maintenance system (HPWH_SPwMPTM) (Figure 10)
- Multi-pass return to primary (HPWH_MPRetP) (Figure 11)

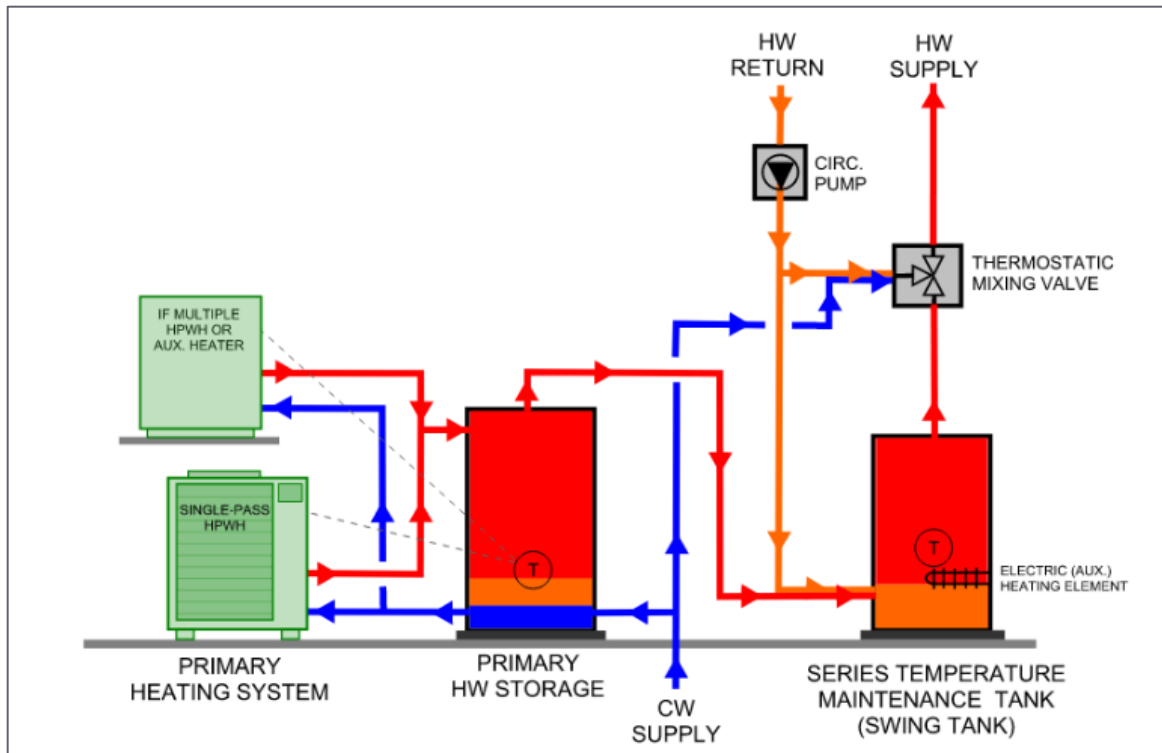

Figure 8: Single-pass primary with electric resistance water heater in series for temperature maintenance system (Ref: NEEA, 2022).

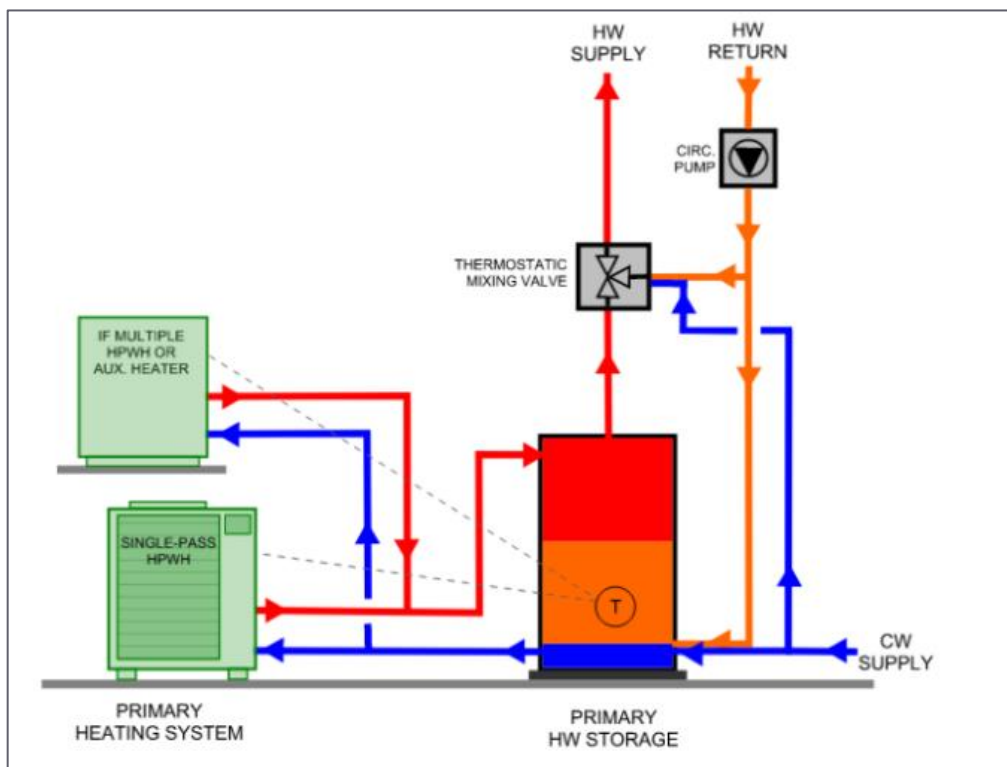

Figure 9: Single-pass return to primary (Ref: NEEA, 2022).

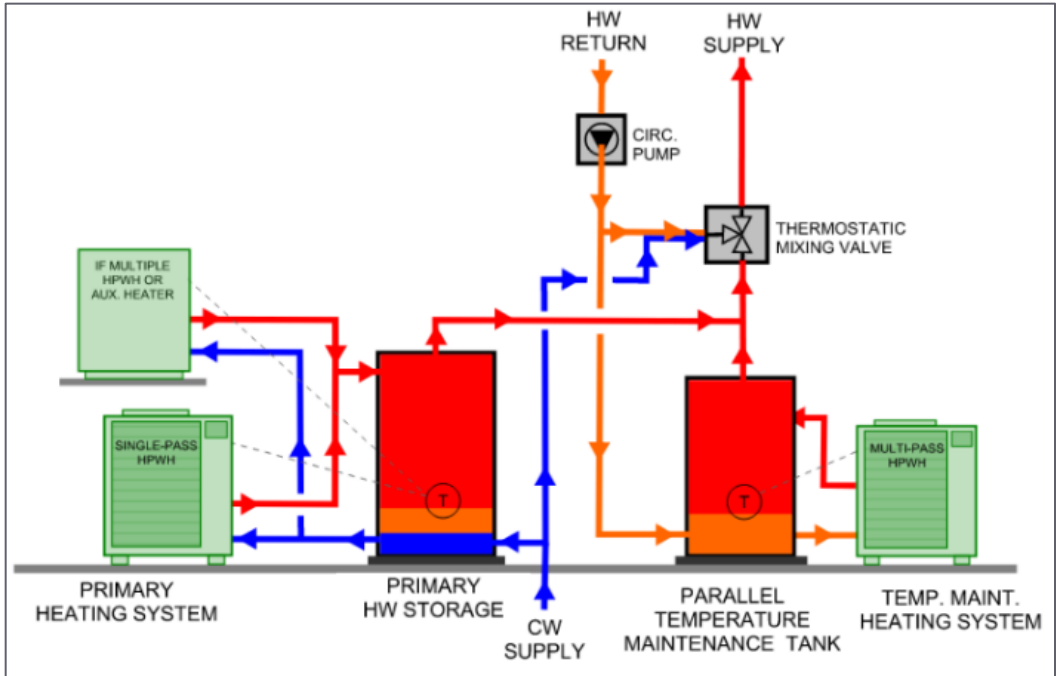

Figure 10: Single-pass primary with multi-pass in parallel for temperature maintenance system (Ref: NEEA, 2022).

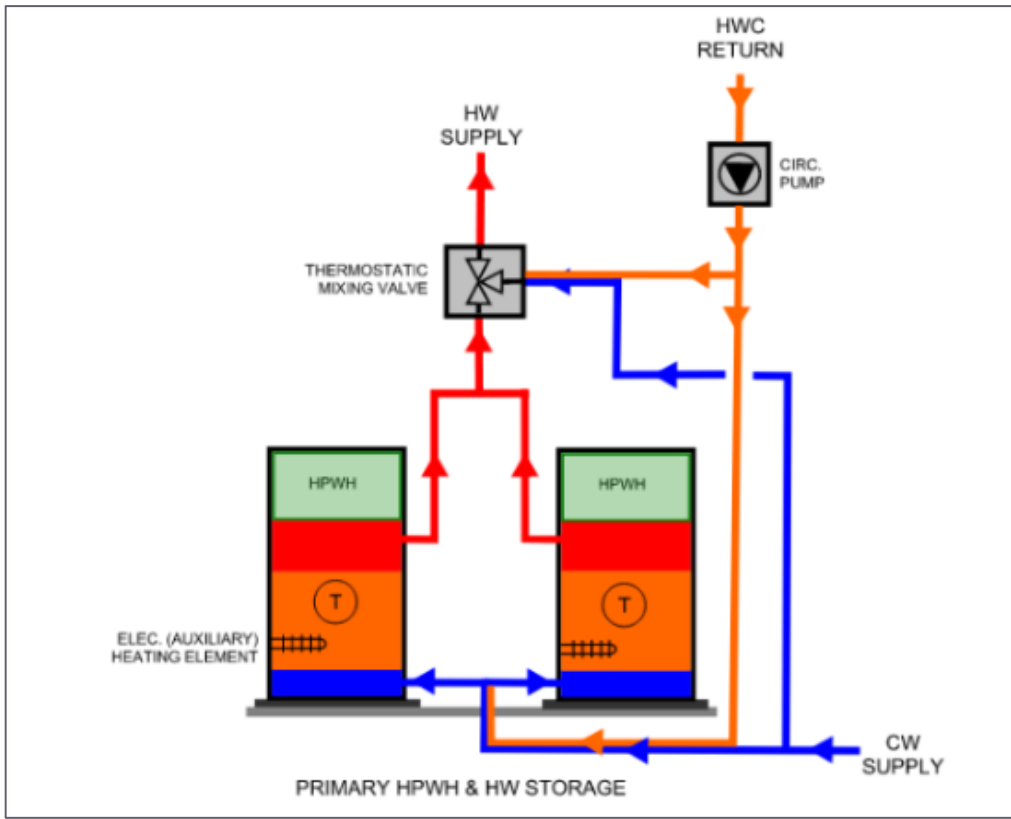

Figure 11: Multi-pass return to primary (Ref: NEEA, 2022).

Figure 12 shows the application of a single-pass system vs. a multi-pass system in multifamily buildings based on the program data, showing that single-pass systems are more common. Figure 13 indicates the different refrigerant types, which shows CO2 (R-744) is the most common. Figure 14 shows that most of the recirculation system is decoupled from the primary system, which aligns with our analysis that most of the primary systems are single-pass, since separating the recirculation system from primary would avoid warm water entering the primary HPWH system to improve its efficiency. Please note that the program data does not consist of all the information for each product, including single-pass/multi-pass, refrigerant type, and recirculation system. Therefore, the total numbers of applications plotted in Figure 12, Figure 13, and Figure 14 do not match each other.

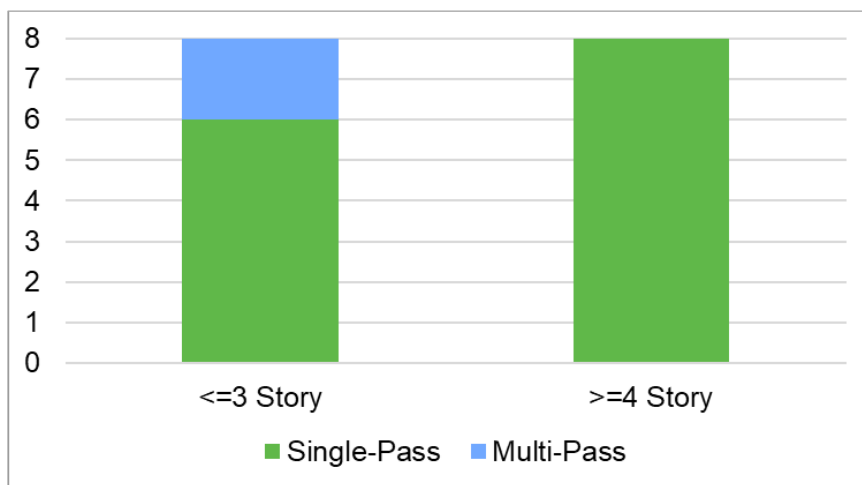

Figure 12: Single-pass vs. multi-pass application.

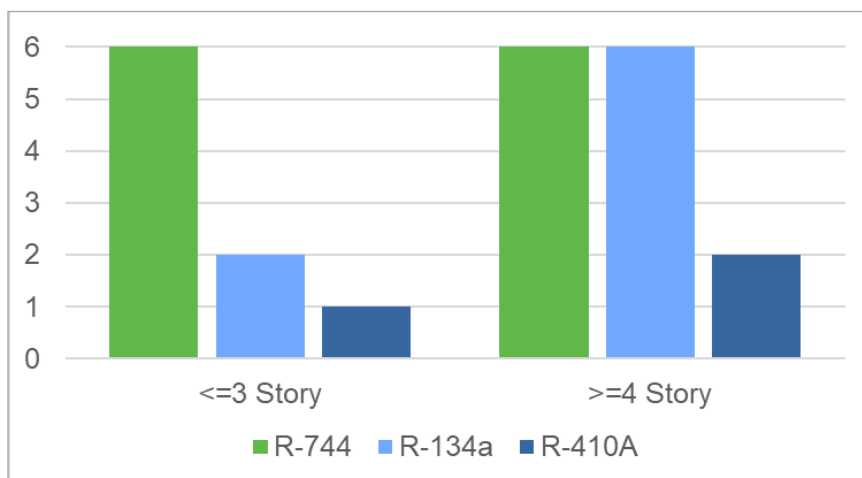

Figure 13: Different refrigerant types.

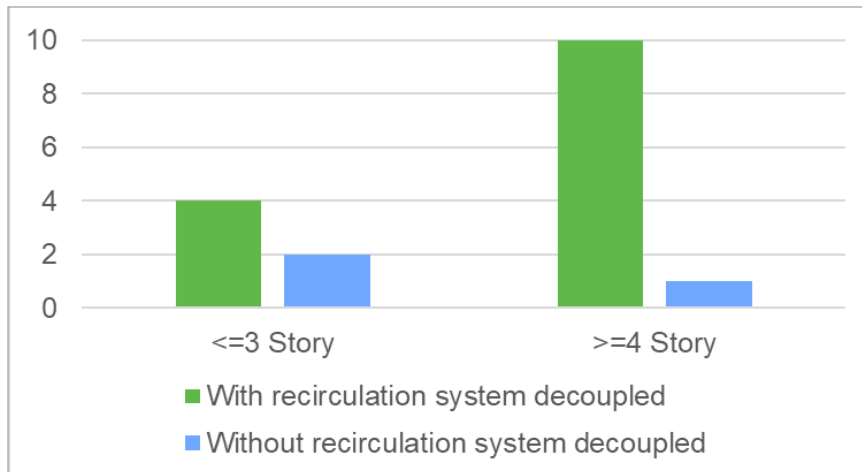

Figure 14: Whether recirculation system is decoupled or not.

7.2.2.3 Market Availability

The Statewide CASE Team performed a market analysis that covers commercial size HPWH units for central system design serving multiple dwelling units.

Under the 2022 code cycle, the Statewide CASE Team’s product research resulted in a list of over 150 air-source HPWH products from 17 manufacturers, of which 41 air-source HPWH were identified to be suitable for central HPWH application by applying the 20 kBtu/hr threshold, except for Sanden units.

The central heat pump water heating market in California is currently in a state of rapid growth and development. Based on the product review in this code cycle, Aermec, AO Smith, Colmac, Rheem, Nyle, Sanden units, Mitsubishi, Mayekawa, Lync, and Transom have products that are currently available in California or with near-term availability, see Figure 15. There are 57 currently or near-term available air-source HPWH that the Statewide CASE Team identified to be suitable for central HPWH application.

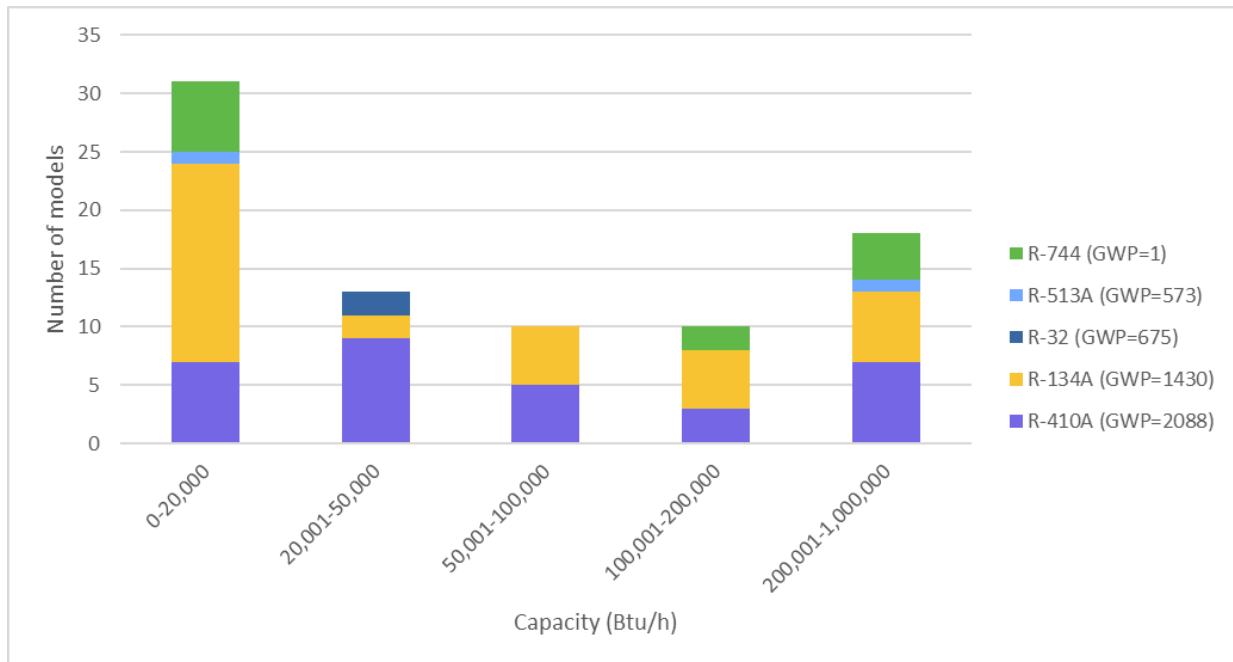

Figure 15: Air source HPWHs: refrigerant per system capacity.

The product offering for low-GWP heat pumps has been expanding. Based on the 2022 CASE Report, there were only 10 low-GWP air source HPWH products, and this number has doubled since 2019. There was only one manufacturer (Sanden) in 2019, which increased to five by 2022/2023:

- Nyle introduced e-series low GWP HPWHs e360 with R-513A refrigerant.
- Mitsubishi Electric Trane HVAC US introduced a large-capacity CO₂ Heat pump into U.S. market.
- Mayekawa also introduced UNIMO AW air heat source CO₂ heat pump into the U.S. market.
- Lync introduced Aegis A series air source CO₂ heat pump.
- Transom Hatch Air Sourced CO₂ heat pump, manufacturer indicated model to be available by 2023.

Multiple other companies that sell central HPWH equipment in other markets (such as Asia, Europe, and Australia) have indicated to the Statewide CASE Team that they would be bringing those products to the California market in the next two years, as well as working to develop additional products.

In addition to product development, many manufacturers are developing plug-and-play packages as a new market delivery method. Through interviews, multiple central HPWH practitioners expressed a desire for more robust design assistance and/or plug-and-play configurations with heat pump, storage tank(s), controls, and associated components to reduce the engineering burden and potential installation issues. Plug-and-play delivery

approaches can help reduce first cost of the system too. Examples of such ongoing effort include:

- Mitsubishi HEAT2O in plug-and-play skid-mounted package as Origin by Steffes.
- SanCO2 (formerly Sanden) is collaborating with skid manufacturers to create skid packages or site assembled HPWH systems.

7.2.2.4 NEEA AWHS

NEEA has recently expanded AWHS to include commercial, multifamily, and industrial water heating systems in addition to residential water heaters (NEEA 2022).

This specification addresses the performance of commercial and multifamily heat pump water heating systems. Commercial systems are defined by both product and application characteristics. Commercial systems are larger units applied to multiple loads. The specification is accomplished by creating a list of qualified HPWH product lines (Qualified Products List) that designers, contractors, and governing bodies can reference when designing, regulating, incentivizing, or comparing HPWH systems.

Commercial HPWH systems are rated based on an average annual SysCOP. For each product line, the open-source (under the terms of the GNU General Public License⁶ by the Free Software Foundation, version 3 or higher) Ecosim software provides an annual simulation for every combination of qualified piping configurations recommended by the manufacturer, 16 IECC climate zones relevant to the United States, and three different multifamily building prototypes. Most California climate zones are equivalent to IECC Zone 3-4, and the Minimum SysCOP for each NEEA Tier are listed in Figure 16 below.

	Minimum SysCOP			
	Hot Climate (IECC Zones 1-2)	Mild Climate (IECC Zones 3-4)	Cold Climates (IECC Zones 5-6)	Extremely Cold Climates (IECC Zones 7-8)
Tier 1	1.75	1.50	1.25	1.15
Tier 2	2.25	2.00	1.60	1.50
Tier 3	2.75	2.50	2.25	2.15
Tier 4	3.50	3.00	2.75	2.50

Figure 16: NEEA commercial HPWH system efficiency tiers.

7.2.3 Market Impacts and Economic Assessments

7.2.3.1 Impact on Builders

Builders of residential and commercial structures are directly impacted by many of the measures proposed by the Statewide CASE Team for the 2025 code cycle. It is within the normal practices of these businesses to adjust their building practices to changes in

building codes. When necessary, builders engage in continuing education and training to remain compliant with changes to design practices and building codes.

California’s construction industry comprises approximately 93,000 business establishments and 943,000 employees (see Table 263). For 2022, total estimated payroll would be about \$78 billion. Nearly 72,000 of these business establishments and 473,000 employees are engaged in the residential building sector, while another 17,600 establishments and 369,000 employees focus on the commercial sector. The remainder of establishments and employees work in industrial, utilities, infrastructure, and other heavy construction roles (the industrial sector).

Table 198: California Construction Industry, Establishments, Employment, and Payroll in 2022 (Estimated)

Building Type	Construction Sectors	Establishments	Employment	Annual Payroll (Billions \$)
Residential	All	71,889	472,974	31.2
Residential	Building Construction Contractors	27,948	130,580	9.8
Residential	Foundation, Structure, & Building Exterior	7,891	83,575	5.0
Residential	Building Equipment Contractors	18,108	125,559	8.5
Residential	Building Finishing Contractors	17,942	133,260	8.0
Commercial	All	17,621	368,810	35.0
Commercial	Building Construction Contractors	4,919	83,028	9.0
Commercial	Foundation, Structure, & Building Exterior	2,194	59,110	5.0
Commercial	Building Equipment Contractors	6,039	139,442	13.5
Commercial	Building Finishing Contractors	4,469	87,230	7.4
Industrial, Utilities, Infrastructure, & Other (Industrial+)	All	4,206	101,002	11.4
Industrial+	Building Construction	288	3,995	0.4
Industrial+	Utility System Construction	1,761	50,126	5.5
Industrial+	Land Subdivision	907	6,550	1.0
Industrial+	Highway, Street, and Bridge Construction	799	28,726	3.1
Industrial+	Other Heavy Construction	451	11,605	1.4

Source: (State of California n.d.)

The proposed change to central HPWH requirement would likely affect residential builders but would not impact firms that focus on construction and retrofit of industrial buildings, utility systems, public infrastructure, or other heavy construction. The effects on the residential and commercial building industry would not be felt by all firms and workers, but rather would be concentrated in specific industry subsectors. Table 199

shows the residential building the Statewide CASE Team expects to be impacted by the changes proposed in this report. The new code language would make builders and contractors adjust to and follow new code requirements that hadn't previously existed. The Statewide CASE Team's estimates of the magnitude of these impacts are shown in Section 7.2.4.

Table 199: Specific Subsectors of the California Residential Building Industry by Subsector in 2022 (Estimated)

Residential Building Subsector	Establishments	Employment	Annual Payroll (Billions \$)
New multifamily general contractors	421	6,344	0.7
New housing for-sale builders	189	3,969	0.5
Residential plumbing and HVAC contractors	9,852	75,404	5.1

Source: (State of California n.d.)

7.2.3.2 Impact on Building Designers and Energy Consultants

Adjusting design practices to comply with changing building codes is within the normal practices of building designers. Building codes (including Title 24, Part 6) are typically updated on a three-year revision cycle and building designers and energy consultants engage in continuing education and training in order to remain compliant with changes to design practices and building codes.

Businesses that focus on residential, commercial, institutional, and industrial building design are contained within the Architectural Services sector (NAICS 541310). Table 200 shows the number of establishments, employment, and total annual payroll for Building Architectural Services. The proposed code changes would potentially impact all firms within the Architectural Services sector. The Statewide CASE Team anticipates the impacts for central HPWH requirement to affect firms that focus on multifamily construction.

There is not an NAICS⁷¹ code specific to energy consultants. Instead, businesses that focus on consulting related to building energy efficiency are contained in the Building Inspection Services sector (NAICS 541350), which is comprised of firms primarily

⁷¹ NAICS is the standard used by federal statistical agencies in classifying business establishments for the purpose of collecting, analyzing, and publishing statistical data related to the U.S. business economy. NAICS was developed jointly by the U.S. Economic Classification Policy Committee (ECPC), Statistics Canada, and Mexico's Instituto Nacional de Estadística y Geografía, to allow for a high level of comparability in business statistics among the North American countries. NAICS replaced the Standard Industrial Classification (SIC) system in 1997.

engaged in the physical inspection of residential and nonresidential buildings.⁷² It is not possible to determine which business establishments within the Building Inspection Services sector are focused on energy efficiency consulting. The information shown in Table 200 provides an upper bound indication of the size of this sector in California.

Table 200: California Building Designer and Energy Consultant Sectors in 2022 (Estimated)

Sector	Establishments	Employment	Annual Payroll (Millions \$)
Architectural Services^a	4,134	31,478	3,623.3
Building Inspection Services^b	1,035	3,567	280.7

Source: (State of California n.d.)

- a. Architectural Services (NAICS 541310) comprises private-sector establishments primarily engaged in planning and designing residential, institutional, leisure, commercial, and industrial buildings and structures.
- b. Building Inspection Services (NAICS 541350) comprises private-sector establishments primarily engaged in providing building (residential & nonresidential) inspection services encompassing all aspects of the building structure and component systems, including energy efficiency inspection services.

7.2.3.3 Impact on Occupational Safety and Health

The proposed code change does not alter any existing federal, state, or local regulations pertaining to safety and health, including rules enforced by the California Division of Occupational Safety and Health (DOSH). All existing health and safety rules would remain in place. Complying with the proposed code change is not anticipated to have adverse impacts on the safety or health of occupants or those involved with the construction, commissioning, and maintenance of the building.

7.2.3.4 Impact on Building Owners and Occupants Including Homeowners and Potential First-Time Homeowners

Residential Buildings

According to data from the U.S. Census, American Community Survey (ACS), there were more than 14.5 million housing units in California in 2021 and nearly 13.3 million were occupied (see Table 201). Most housing units (nearly 9.42 million) were single family homes (either detached or attached), approximately 2 million homes were in

⁷² Establishments in this sector include businesses primarily engaged in evaluating a building's structure and component systems and includes energy efficiency inspection services and home inspection services. This sector does not include establishments primarily engaged in providing inspections for pests, hazardous wastes or other environmental contaminants, nor does it include state and local government entities that focus on building or energy code compliance/enforcement of building codes and regulations.

buildings containing two to nine units, and 2.5 million homes were in multifamily buildings containing 10 or more units. The California Department of Revenue estimated that building permits for 67,300 single family and 54,900 multifamily homes would be issued in 2022, up from 66,000 single family and 53,500 multifamily permits in 2021.

Table 201: California Housing Characteristics in 2021^a

Housing Measure	Estimate
Total housing units	14,512,281
Occupied housing units	13,291,541
Vacant housing units	1,220,740
Homeowner vacancy rate	0.7%
Rental vacancy rate	4.3%
Number of 1-unit, detached structures	8,388,099
Number of 1-unit, attached structures	1,030,372
Number of 2-unit structures	348,295
Number of 3- or 4-unit structures	783,663
Number of 5- to 9-unit structures	856,225
Number of 10- to 19-unit structures	740,126
Number of 20+ unit structures	1,828,547
Mobile home, RV, etc.	522,442

Sources: (United States Census Bureau n.d.), (Federal Reserve Economic Data (FRED) n.d.)

a. Total housing units as reported for 2021; all other housing measures estimated based on historical relationships.

Table 202 shows the distribution of California homes by vintage. About 15 percent of California homes were built in 2000 or later and another 11 percent built between 1990 and 1999. The majority of California’s existing housing stock (8.5 million homes – 59 percent of the total) were built between 1950 and 1989, a period of rapid population and economic growth in California. Finally, about 2.1 million homes in California were built before 1950. According to Kenney et al, 2019, more than half of California’s existing multifamily buildings (those with five or more units) were constructed before 1978 when there was no California Energy Code (Kenney 2019).

Table 202: Distribution of California Housing by Vintage in 2021 (Estimated)

Home Vintage	Units	Percent	Cumulative Percent
Built 2014 or later	348,296	2.4	2.4
Built 2010 to 2013	261,221	1.8	4.2
Built 2000 to 2009	1,581,839	10.9	15.1
Built 1990 to 1999	1,596,351	11.0	26.1
Built 1980 to 1989	2,191,354	15.1	41.2
Built 1970 to 1979	2,539,649	17.5	58.7
Built 1960 to 1969	1,915,621	13.2	71.9
Built 1950 to 1959	1,930,133	13.3	85.2
Built 1940 to 1949	841,712	5.8	91.0
Built 1939 or earlier	1,306,105	9.0	100.0
Total housing units	14,512,281	100.0	100.0

Sources: (United States Census Bureau n.d.), (Federal Reserve Economic Data (FRED) n.d.)

Table 203 shows the distribution of owner- and renter-occupied housing by household income. Overall, about 55 percent of California housing is owner-occupied and the rate of owner-occupancy generally increases with household income. The owner-occupancy rate for households with an income below \$50,000 is only 37 percent, whereas the owner occupancy rate is 71 percent for households earning \$100,000 or more.

Table 203: Owner- and Renter-Occupied Housing Units in California by Income in 2021 (Estimated)

Household Income	Total	Owner Occupied	Renter Occupied
Less than \$5,000	353,493	113,315	240,178
\$5,000 to \$9,999	254,304	74,939	179,366
\$10,000 to \$14,999	495,287	134,633	360,654
\$15,000 to \$19,999	412,498	144,064	268,435
\$20,000 to \$24,999	467,694	169,431	298,264
\$25,000 to \$34,999	906,996	355,968	551,028
\$35,000 to \$49,999	1,319,892	560,453	759,438
\$50,000 to \$74,999	2,036,560	990,769	1,045,791
\$75,000 to \$99,999	1,662,032	920,607	741,425
\$100,000 to \$149,999	2,307,889	1,490,247	817,642
\$150,000 or more	3,074,895	2,337,651	737,244
Total Housing Units	13,291,541	7,292,076	5,999,465

Source: (United States Census Bureau n.d.), (Federal Reserve Economic Data (FRED) n.d.)

Understanding the distribution of California residents by home type, home vintage, and household income is critical for developing meaningful estimates of the economic impacts associated with proposed code changes affecting residents. Many proposed code changes specifically target single family or multifamily residences, so the counts of housing units by building type shown in Table 201 through Table 203 provides the information necessary to quantify the magnitude of potential impacts. Likewise, impacts may differ for owners and renters, by home vintage, and by household income, information provided in Table 202 and Table 203.

Estimating Impacts

For California residents, the proposed code changes would result in lower energy bills. The Statewide CASE Team estimates that on average the proposed change to Title 24, Part 6 would increase construction cost by about \$207 per multifamily dwelling unit, but the measure would also result in an average savings of \$2,281 in energy and maintenance cost savings over 30 years. Assuming a six percent interest rate, this is roughly equivalent to a \$1.24 per month increase in payments for a 30-year mortgage and a \$6.33 per month reduction in energy costs. Overall, the Statewide CASE Team expects the 2025 Title 24, Part 6 Standards to save homeowners about \$61.08 per year relative to homeowners whose multifamily dwelling units are minimally compliant with the 2022 Title 24, Part 6 requirements. As discussed in Section 7.2.4.1, when homeowners or building occupants save on energy bills, they tend to spend it elsewhere thereby creating jobs and economic growth for the California economy. Energy cost savings can be particularly beneficial to low-income homeowners who typically spend a higher portion of their income on energy bills, often have trouble paying energy bills, and sometimes go without other necessities to save money for energy bills (Association, National Energy Assistance Directors 2011).

7.2.3.5 Impact on Building Component Retailers (Including Manufacturers and Distributors)

The Statewide CASE Team anticipates the proposed change would have no material impact on California component retailers.

7.2.3.6 Impact on Building Inspectors

Table 204 shows employment and payroll information for state and local government agencies in which many inspectors of residential and commercial buildings are employed. Building inspectors participate in continuing education and training to stay current on all aspects of building regulations, including energy efficiency. The Statewide CASE Team, therefore, anticipates the proposed change would have no impact on employment of building inspectors or the scope of their role conducting energy efficiency inspections.

Table 204: Employment in California State and Government Agencies with Building Inspectors in 2022 (Estimated)

Sector	Govt.	Establishments	Employment	Annual Payroll (Million \$)
Administration of Housing Programs ^a	State	18	265	29.0
	Local	38	3,060	248.6
Urban and Rural Development Admin ^b	State	38	764	71.3
	Local	52	2,481	211.5

Source: (State of California, Employment Development Department n.d.)

- a. Administration of Housing Programs (NAICS 925110) comprises government establishments primarily engaged in the administration and planning of housing programs, including building codes and standards, housing authorities, and housing programs, planning, and development.
- b. Urban and Rural Development Administration (NAICS 925120) comprises government establishments primarily engaged in the administration and planning of the development of urban and rural areas. Included in this industry are government zoning boards and commissions.

7.2.3.7 Impact on Statewide Employment

As described in Sections 7.2.3.1 through 7.2.3.6 , the Statewide CASE Team does not anticipate significant employment or financial impacts to any sector of the California economy. This is not to say that the proposed change would not have modest impacts on employment in California. In Section 7.2.4, the Statewide CASE Team estimated the proposed change in central HPWH requirement would affect statewide employment and economic output directly and indirectly through its impact on builders, designers and energy consultants, and building inspectors. In addition, the Statewide CASE Team estimated how energy savings associated with the proposed change in central HPWH requirement would lead to modest ongoing financial savings for California residents, which would then be available for other economic activities.

7.2.4 Economic Impacts

For the 2025 code cycle, the Statewide CASE Team used the IMPLAN model software⁷³, along with economic information from published sources and professional judgement, to develop estimates of the economic impacts associated with each of the proposed code changes. Conceptually, IMPLAN estimates jobs created as a function of incoming cash flow in different sectors of the economy, due to implementing a code or a standard. The jobs created are typically categorized into direct, indirect, and induced employment. For example, cash flow into a manufacturing plant captures direct employment (jobs created in the manufacturing plant), indirect employment (jobs

⁷³ IMPLAN employs economic data and advanced economic impact modeling to estimate economic impacts for interventions like changes to the California Title 24, Part 6 code. For more information on the IMPLAN modeling process, see www.IMPLAN.com.

created in the sectors that provide raw materials to the manufacturing plant) and induced employment (jobs created in the larger economy due to purchasing habits of people newly employed in the manufacturing plant). Eventually, IMPLAN computes the total number of jobs created due to a code. The assumptions of IMPLAN include constant returns to scale, fixed input structure, industry homogeneity, no supply constraints, fixed technology, and constant byproduct coefficients. The model is also static in nature and is a simplification of how jobs are created in the macro-economy.

The economic impacts developed for this report are only estimates and are based on limited and to some extent speculative information. The IMPLAN model provides a relatively simple representation of the California economy and, though the Statewide CASE Team is confident that the direction and approximate magnitude of the estimated economic impacts are reasonable, it is important to understand that the IMPLAN model is a simplification of extremely complex actions and interactions of individual, businesses, and other organizations as they respond to changes in energy efficiency codes. In all aspect of this economic analysis, the CASE Authors rely on conservative assumptions regarding the likely economic benefits associated with the proposed code change. By following this approach, the economic impacts presented below represent lower bound estimates of the actual benefits associated with this proposed code change.

Adoption of this code change proposal would result in relatively modest economic impacts through the additional direct spending those in the residential building and remodeling industry as well as indirectly as residents spend all or some of the money saved through lower utility bills on other economic activities.⁷⁴ There may also be some nonresidential customers that are impacted by this proposed code change; however, the Statewide CASE Team does not anticipate such impacts to be materially important to the building owner and would have measurable economic impacts.

Table 205: Estimated Impact that Adoption of the Proposed Measure would have on California Building Inspectors

Type of Economic Impact	Employment (Jobs)	Labor Income	Total Value Added	Output
Direct Effects (Additional spending by Building Inspectors)	0.9	\$98,808	\$117,174	\$142,389
Indirect Effect (Additional spending by firms supporting Building Inspectors)	0.1	\$9,151	\$14,252	\$24,823
Induced Effect (Spending by employees of Building Inspection Bureaus and Departments)	0.5	\$31,078	\$55,671	\$88,610
Total Economic Impacts	1.4	\$139,036	\$187,097	\$255,822

Source: Statewide CASE Team analysis of data from the IMPLAN modeling software.

⁷⁴ For example, for the lowest income group, the Statewide CASE Team assumes 100 percent of money saved through lower energy bills would be spent, while for the highest income group, the Statewide CASE Team assumes only 64 percent of additional income would be spent.

7.2.4.1 Creation or Elimination of Jobs

The Statewide CASE Team does not anticipate that the measures proposed for the 2025 code cycle regulation would lead to the creation of new *types* of jobs or the elimination of *existing* types of jobs. In other words, the Statewide CASE Team’s proposed change would not result in economic disruption to any sector of the California economy. Rather, the estimates of economic impacts discussed in Section 7.2.4 would lead to modest changes in employment of existing jobs.

7.2.4.2 Creation or Elimination of Businesses in California

As stated in Section 7.2.4.1, the Statewide CASE Team’s proposed change would not result in economic disruption to any sector of the California economy. The proposed change represents a modest change to code language which would not excessively burden or competitively disadvantage California businesses—nor would it necessarily lead to a competitive advantage for California businesses. Therefore, the Statewide CASE Team does not foresee any new businesses being created, nor does the Statewide CASE Team think any existing businesses would be eliminated due to the proposed code changes.

7.2.4.3 Competitive Advantages or Disadvantages for Businesses in California

The proposed code changes would apply to all businesses incorporated in California, regardless of whether the business is located inside or outside of the state.⁷⁵ Therefore, the Statewide CASE Team does not anticipate that these measures proposed for the 2025 code cycle regulation would have an adverse effect on the competitiveness of California businesses. Likewise, the Statewide CASE Team does not anticipate businesses located outside of California would be advantaged or disadvantaged.

7.2.4.4 Increase or Decrease of Investments in the State of California

The Statewide CASE Team analyzed national data on corporate profits and capital investment by businesses that expand a firm’s capital stock (referred to as net private domestic investment, or NPDI).⁷⁶ As Table 206 shows, between 2017 and 2021, NPDI as a percentage of corporate profits ranged from a low of 18 in 2020 due to the worldwide economic slowdowns associated with the COVID 19 pandemic to a high of 35 percent in 2019, with an average of 26 percent. While only an approximation of the proportion of business income used for net capital investment, the Statewide CASE

⁷⁵ Gov. Code, §§ 11346.3(c)(1)(C), 11346.3(a)(2); 1 CCR § 2003(a)(3) Competitive advantages or disadvantages for California businesses currently doing business in the state.

⁷⁶ Net private domestic investment is the total amount of investment in capital by the business sector that is used to expand the capital stock, rather than maintain or replace due to depreciation. Corporate profit is the money left after a corporation pays its expenses.

Team believes it provides a reasonable estimate of the proportion of proprietor income that would be reinvested by business owners into expanding their capital stock.

Table 206: Net Domestic Private Investment and Corporate Profits, U.S.

Year	Net Domestic Private Investment by Businesses, Billions of Dollars	Corporate Profits After Taxes, Billions of Dollars	Ratio of Net Private Investment to Corporate Profits (Percent)
2017	518.473	1882.460	28
2018	636.846	1977.478	32
2019	690.865	1952.432	35
2020	343.620	1908.433	18
2021	506.331	2619.977	19
5-Year Average	-	-	26

Source: (Federal Reserve Economic Data (FRED) n.d.)

The Statewide CASE Team does not anticipate that the economic impacts associated with the proposed measure would lead to significant change (increase or decrease) in investment, directly or indirectly, in any affected sectors of California’s economy. Nevertheless, the Statewide CASE Team can derive a reasonable estimate of the change in investment by California businesses based on the estimated change in economic activity associated with the proposed measure and its expected effect on proprietor income, which the Statewide CASE Team uses a conservative estimate of corporate profits, a portion of which the Statewide CASE Team assumes would be allocated to net business investment.⁷⁷

7.2.4.5 Incentives for Innovation in Products, Materials, or Processes

This proposed code includes an alternative prescriptive path that leverages NEEA AWHs specifications. Manufacturers need to submit performance data for their product and system designs to be included in the Qualified Product List. This option provides a compliance path to any HPWH type and encourages manufacturers to improve HPWH equipment and system design approach to meet a performance requirement.

7.2.4.6 Effects on the State General Fund, State Special Funds, and Local Governments

The Statewide CASE Team does not expect the proposed code changes would have a measurable impact on the California’s General Fund, any state special funds, or local government funds.

⁷⁷ 26 percent of proprietor income was assumed to be allocated to net business investment; see Table 272.

Cost of Enforcement

Cost to the State: State government already has budget for code development, education, and compliance enforcement. While state government would be allocating resources to update the Title 24, Part 6 Standards, including updating education and compliance materials and responding to questions about the revised requirements, these activities are already covered by existing state budgets. The costs to state government are small when compared to the overall costs savings and policy benefits associated with the code change proposals.

Cost to Local Governments: All proposed code changes to Title 24, Part 6 would result in changes to compliance determinations. Local governments would need to train building department staff on the revised Title 24, Part 6 Standards. While this re-training is an expense to local governments, it is not a new cost associated with the 2025 code change cycle. The building code is updated on a triennial basis, and local governments plan and budget for retraining every time the code is updated. There are numerous resources available to local governments to support compliance training that can help mitigate the cost of retraining, including tools, training and resources provided by the IOU Codes and Standards program (such as Energy Code Ace). As noted in Section 7.1.5 and Appendix E, the Statewide CASE Team considered how the proposed code change might impact various market actors involved in the compliance and enforcement process and aimed to minimize negative impacts on local governments.

7.2.4.7 Impacts on Specific Persons

While the objective of any of the Statewide CASE Team's proposal is to promote energy efficiency, the Statewide CASE Team recognizes that there is the potential that a proposed code change may result in unintended consequences. Refer to Section 7.6 for more details addressing energy equity and environmental justice.

7.2.5 Fiscal Impacts

7.2.5.1 Mandates on Local Agencies or School Districts

There are no relevant mandates to school districts, because this only impacts multifamily buildings. There are also no mandates for local agencies because the requirements would be specified at the statewide level through Title 24, Part 6.

7.2.5.2 Costs to Local Agencies or School Districts

There are no costs to school districts, because this only impacts multifamily buildings. For local agencies, The Statewide CASE Team does not anticipate any increase in work for building inspectors.

7.2.5.3 Costs or Savings to Any State Agency

There are no costs or savings to state agencies because they would not be involved in enforcement of the measure.

7.2.5.4 Other Non-Discretionary Cost or Savings Imposed on Local Agencies

There are no added non-discretionary costs or savings to local agencies.

7.2.5.5 Costs or Savings in Federal Funding to the State

There are no costs or savings to federal funding to the state due to the measure. The proposed measure is a relatively small cost which the market would bear. The state would not require federal funding to implement the proposed measure.

7.3 Energy Savings

The Statewide CASE Team gathered stakeholder input to inform the energy savings analysis, which was considered and analyzed in the technical feasibility and market availability section (Section 7.2.2). The Statewide CASE Team took those findings in Section 7.2.2 to create the following energy saving modeling assumptions and methodology for the Central HPWH measure. See Appendix F: Summary of Stakeholder Engagement for a summary of stakeholder engagement.

Energy savings benefits may have potential to disproportionately impact DIPs. Refer to Section 7.6 for more details addressing energy equity and environmental justice.

7.3.1 Energy Savings Methodology

7.3.1.1 Key Assumptions for Energy Savings Analysis

Build on research findings presented in Section 7.2.2 technical feasibility and market availability, the Statewide CASE Team worked with an experienced HPWH design consultant firm to develop the basis of design (BOD) for baseline and proposed central HPWH systems for the four multifamily prototype buildings. Key assumptions are summarized here, and in Appendix K: Central HPWH Clean-up Basis of Design, Modeling and Cost Analysis Details, which provides detailed system sizing criteria, equipment selection, and plumbing configurations. The sizing calculations were based on the 2022 Multifamily All-Electric Pathway CASE analysis, the Statewide CASE Team updated equipment selection and plumbing configurations.

The base case models are the Standard Design with modifications to reflect currently available HPWH products, since the Standard Design uses generic heat pump.⁷⁸ The proposed models represent common design approaches, which cover different configurations of central HPWH systems.

The Statewide CASE Team conducted energy savings analysis using the prototype building models using the 2025-0.3 Research Version of the CBECC software for both the baseline and proposed cases (California Energy Commission n.d.).

7.3.1.2 Energy Savings Methodology per Prototypical Building

The Statewide CASE Team measured per-unit energy savings expected from the proposed code changes in several ways to quantify key impacts. First, savings are calculated by fuel type. Electricity savings are measured in terms of both energy usage and peak demand reduction. Natural gas savings are quantified in terms of energy usage. Second, the Statewide CASE Team calculated Source Energy Savings. Source Energy represents the total amount of raw fuel required to operate a building. In addition to all energy used from on-site production, source energy incorporates all transmission, delivery, and production losses. The hourly source energy values provided by the CEC are strongly correlated with GHG emissions.⁷⁹ Finally, the Statewide CASE Team calculated LSC savings, formerly known as Time Dependent Valuation (TDV) energy cost savings. LSC Savings are calculated using hourly LSC factors for both electricity and natural gas provided by the CEC. These LSC hourly factors are projected over the 30-year life of the building, and they incorporate the hourly cost of marginal generation, transmission and distribution, fuel, capacity, losses, and cap-and-trade-based CO₂ emissions.¹²

The CEC directed the Statewide CASE Team to model the energy impacts using specific prototypical building models that represent typical building geometries for different types of buildings (California Energy Commission 2022). The prototype buildings that the Statewide CASE Team used in the analysis are presented in Table 207.

⁷⁸ 2022 Nonresidential and Multifamily ACM Reference Manual defines the generic heat pump, which is a heat pump based on the R-134 refrigerant operating cycle. The primary heat pump output capacity and the primary storage tank capacity are automatically sized with the assumption that the system runs for approximately sixteen hours so that the heat pump and primary storage volume jointly meet the peak water draw period used on the design day by the algorithm.

⁷⁹ See hourly factors for source energy, LSC, and GHG emissions at <https://www.energy.ca.gov/files/2025-energy-code-hourly-factors>

Table 207: Prototype Buildings Used for Energy, Demand, Cost, and Environmental Impacts Analysis

Prototype Name	Number of Stories	Floor Area (Square Feet)	Description
LowRiseGarden	2	7,680	2-story, 8-unit apartment building. Average dwelling unit size: 960 ft ² . Central HPWH DHW: HPWH_SPST
LoadedCorridor	3	40,000	3-story, 36-unit apartment building. Average dwelling unit size: 960 ft ² . Central HPWH DHW: HPWH_SPST
MidRiseMixedUse	5	113,100	4-story (4-story residential, 1-story commercial), 88-unit building. Avg dwelling unit size: 870 ft ² . Central HPWH DHW: HPWH_SPST
HighRiseMixedUse	10	125,400	10-story (9-story residential, 1-story commercial), 117-unit building. Avg dwelling unit size: 850 ft ² . Central HPWH DHW: HPWH_SPST

The Statewide CASE Team estimated LSC, Source Energy, electricity, natural gas, peak demand, and GHG impacts by simulating the proposed code change in EnergyPlus using prototypical buildings and rulesets from the 2025-0.3 Research Version of the CBECC software (California Energy Commission n.d.).

CBECC generates two models based on user inputs: the Standard Design and the Proposed Design.⁸⁰ The Standard Design represents the geometry of the prototypical building and a design that uses a set of features that result in a LSC budget and Source Energy budget that is minimally compliant with 2022 Title 24, Part 6 code requirements. Features used in the Standard Design are described in the 2022 Nonresidential and Multifamily ACM Reference Manual. The Proposed Design represents the same geometry as the Standard Design, but it assumes the energy features that the software user describes with user inputs. To develop savings estimates for the proposed code changes, the Statewide CASE Team created a Standard Design and Proposed Design for each prototypical building, with the Standard Design representing compliance with 2022 code and the Proposed Design representing compliance with the proposed requirements. Comparing the energy impacts of the Standard Design to the Proposed Design reveals the impacts of the proposed code change relative to a building that is minimally compliant with the 2022 Title 24, Part 6 requirements that follow industry typical practices.

⁸⁰ CBECC creates a third model, the Reference Design, that represents a building like the Proposed Design, but with construction and equipment parameters that are minimally compliant with the 2006 IECC. The Statewide CASE Team did not use the Reference Design for energy impacts evaluations.

The existing Title 24, Part 6 requirement covers the DHW systems that apply to new construction, so the Standard Design is minimally compliant with the 2022 Title 24, Part 6 requirements. The Statewide CASE Team used assumptions for DHW Standard Design based on the 2022 Title 24, Part 6 Nonresidential and Multifamily ACM Reference Manual with the following assumptions:

- The standard design has a HPWH_SPST configuration.
- The primary single-pass heat pump is a generic heat pump based on the R-134 refrigerant operating cycle.
- The secondary tank volume is 80 if there are up to 48 dwelling units or 120 if there are more than 48 dwelling units.
- Both the primary and secondary storage tanks have insulation R-values of 16 (°F ft² hr/Btu) insulation.
- The locations of the standard design storage tanks and heat pumps are the same as proposed design.
- The temperature setpoints are 140°F for primary single-pass HPWH and 136°F for secondary water heater.
- Thermostatic mixing valve outlet: 125°F.
- The efficiency and standby losses match the appropriate minimum federal requirements.

For both base case and proposed Central HPWH measures, the Statewide CASE Team worked with an experienced HPWH design consultant firm to develop the BOD for the central HPWHs for the four multifamily prototype buildings.

For the base case, the Statewide CASE Team made modifications to the standard design to replace the generic primary heat pump with a real product with the same refrigerant R-134a for buildings four stories and higher. For buildings three stories and lower, the team decided to use a product using R-410A refrigerant, because there is no appropriate product using R-134 refrigerant for the applications.

The proposed central HPWH systems design represents current common practice in the industry, including:

- Single-pass Primary with HPWH_SPST
- Single-pass Return to Primary (HPWH_SPRetP)
- Single-pass Primary with Multi-pass in parallel for Temperature Maintenance System (HPWH_SPwMPTM)
- Multi-pass Return to Primary (HPWH_MPRetP)

Table 208 summarizes the characteristics for the investigated Central HPWH configurations.

Table 208: Central HPWH Configuration Characteristics

Central HPWH System Components	HPWH_SPST (base model)	HPWH_SPST (proposed model)	HPWH_MPRetP (proposed model)	HPWH_SPRetP (proposed model)	HPWH_SPwMPTM (proposed model)
Primary HPWH type	Single-pass	Single-pass	Multi-pass	Single-pass	Single-pass
Primary system refrigerant	R-410A (3-story and lower);	R-744	R-410A (3-story and lower);	R-410A (3-story and lower);	R-744 (Only applicable for 4-story and higher)
	R-134a (4-story and higher)	R-744	R-134a (4-story and higher)	R-134a (4-story and higher)	R-744 (Only applicable for 4-story and higher)
Primary to TMS configuration	In series	In series	NA	NA	In parallel
TMS heater	Electric Resistance Water Heater	Electric Resistance Water Heater	NA	NA	Split HP with storage tank

Table 209 through Table 212 on the next pages present precisely which parameters were modified and what values were used in the Standard Design and Proposed Design for each prototype. Specifically, the proposed conditions assume four different qualified configurations based on AWHI 8.0.

Table 209: Modifications Made to Standard Design in LowRiseGarden Prototype to Simulate Proposed Code Change – All Climate Zones

Objects Modified	Parameter Name	Standard Design Parameter Value	Proposed Design Parameter Value 1	Proposed Design Parameter Value 2	Proposed Design Parameter Value 3
DHW System Data	Configuration	HPWH_SPST	HPWH_SPST	HPWH_SPRetP	HPWH_MPRetP
	Central / Recirculation	Central with Recirculation	Central with Recirculation	Central with Recirculation	Central with Recirculation
	Central Type	HPWH	HPWH	HPWH	HPWH
	Dwelling Unit Distribution	Standard	Standard	Standard	Standard
	Recirc Pump Power	85	85	85	85
Central HPWH	Central HPWH Primary System Type	Single Pass Primary	Single Pass Primary	Single Pass Primary	Multi Pass Primary
	HPWH/Compressor Model	Colmac CxV-5 (14kW cap @ 40F)	Sanden GS3-45HPA-US (4kW cap @40F)	Colmac CxV-5 (14kW cap @ 40F)	Colmac CxV-5 (MP, 14kW cap @ 40F)
	Compressor/Heater Count	1	1	1	2
	Total Tank Vol	119	119	119	119
	Tank Count	1	1.00	1.00	1
	Tank R-Value	R-16	R-16	R-16	R-16
	Tank Location	Conditioned zone	Conditioned zone	Conditioned zone	Conditioned zone
	Source Air From	Outside	Outside	Outside	Outside
	Secondary Tank Type	Series (Swing)	Series (Swing)	None (return to Primary)	None (return to Primary)
	Secondary Tank Type	Electric Resistance	Electric Resistance	NA	NA
	HPWH/Compressor Model	NA	NA	NA	NA
	Heater Count	1	1	NA	NA
	Total Tank Vol	80	80	NA	NA
	Tank Count	1	1	NA	NA
	Tank R-Value	16	R-16	NA	NA
	Tank Location	Conditioned zone	Conditioned zone	NA	NA
	Source Air From	NA	NA	NA	NA
Recirculation Loops	Number of Loops	1	1	1	1
	Loop Insulation Thickness	2	2	2	2
	Loop Location	Conditioned	Conditioned	Conditioned	Conditioned

Table 210: Modifications Made to Standard Design in LoadedCorridor Prototype to Simulate Proposed Code Change – All Climate Zones

Objects Modified	Parameter Name	Standard Design Parameter Value	Proposed Design Parameter Value 1	Proposed Design Parameter Value 2	Proposed Design Parameter Value 3
DHW System Data	Configuration	SP Primary with ERWH in series for TMS	SP Primary with ERWH in series for TMS	SP Return to Primary	MP Return to Primary
	Central / Recirculation	Central with Recirculation	Central with Recirculation	Central with Recirculation	Central with Recirculation
	Central Type	HPWH	HPWH	HPWH	HPWH
	Dwelling Unit Distribution	Standard	Standard	Standard	Standard
	Recirc Pump Power	150	150	150	150
Central HPWH	Central HPWH Primary System Type	Single Pass Primary	Single Pass Primary	Single Pass Primary	Multi Pass Primary
	HPWH/Compressor Model	Colmac CxV-5 (14kW cap @ 40F)	Sanden GS3-45HPA-US (4kW cap @40F)	Colmac CxV-5 (14kW cap @ 40F)	Colmac CxV-5 (MP, 14kW cap @ 40F)
	Compressor/Heater Count	3	5.00	3	6.00
	Total Tank Vol	294	294	370	432
	Tank Count	1	1	3	1
	Tank R-Value	R-16	R-16	R-16	R-16
	Tank Location	Zone F1 Mech Rm	Zone F1 Mech Rm	Zone F1 Mech Rm	Zone F1 Mech Rm
	Source Air From	Outside	Outside	Outside	Outside
	Secondary Tank Type	Series (Swing)	Series (Swing)	None (return to Primary)	None (return to Primary)
	Secondary Tank Type	Electric Resistance	Electric Resistance	NA	NA
	HPWH/Compressor Model	NA	NA	NA	NA
	Heater Count	1	1	NA	NA
	Total Tank Vol	120	120.00	NA	NA
	Tank Count	1	1	NA	NA
	Tank R-Value	R-16	R-16	NA	NA
	Tank Location	Zone F1 Mech Rm	Zone F1 Mech Rm	NA	NA
	Source Air From	NA	NA	NA	NA
Recirculation Loops	Number of Loops	1	1.00	1	1.00
	Loop Insulation Thickness	2	2	2	2
	Loop Location	Conditioned	Conditioned	Conditioned	Conditioned

Table 211: Modifications Made to Standard Design in MidRiseMixedUse Prototype to Simulate Proposed Code Change – All Climate Zones

Objects Modified	Parameter Name	Standard Design Parameter Value	Proposed Design Parameter Value 1	Proposed Design Parameter Value 2	Proposed Design Parameter Value 3	Proposed Design Parameter Value 4
DHW System Data	Configuration	SP Primary with ERWH in series for TMS	SP Primary with ERWH in series for TMS	SP Return to Primary	MP Return to Primary	SP Primary with MP in parallel for TMS
	Central / Recirculation	Central with Recirculation	Central with Recirculation	Central with Recirculation	Central with Recirculation	Central with Recirculation
	Central Type	HPWH	HPWH	HPWH	HPWH	HPWH
	Dwelling Unit Distribution	Standard	Standard	Standard	Standard	Standard
	Recirc Pump Power	179	179	179	179	179
Central HPWH	Central HPWH Primary System Type	Single Pass Primary	Single Pass Primary	Single Pass Primary	Single Pass Primary	Multi Pass Primary
	HPWH/ Compressor Model	Colmac CxA-20 (41kW cap @ 40F)	2 Mitsubishi Heat2O; Sanden GS3-45HPA-US (4kW cap @40F)	1 Mitsubishi Heat2O; Sanden GS3-45HPA-US (4kW cap @40F)	2 Nyle E360 in the model; Colmac CxA-20 (41kW cap @ 40F)	Colmac CxA-20 (MP, 41kW cap @ 40F)
	Compressor/Heater Count	2	11.00	8	3.00	3
	Total Tank Vol	720	720	830	864	1,000
	Tank Count	2	2	2	2	2
	Tank R-Value	R-16	R-16	R-16	R-16	R-16
	Tank Location	Zone UG Garage	Zone UG Garage	Zone UG Garage	Zone UG Garage	Zone UG Garage
	Source Air From	Zone UG Garage	Zone UG Garage	Zone UG Garage	Zone UG Garage	Zone UG Garage
	Secondary Tank Type	Series (Swing)	Series (Swing)	Parallel	None (return to Primary)	None (return to Primary)
	Secondary Tank Type	Electric Resistance	Electric Resistance	Multi Pass Primary	NA	NA
	HPWH/ Compressor Model	NA	NA	Colmac CxV-5 (MP, 14kW cap @ 40F)	NA	NA
	Heater Count	1	1	2	NA	NA
	Total Tank Vol	150	150.00	175	NA	NA
	Tank Count	1	1	1	NA	NA
	Tank Location	Zone UG Garage	Zone UG Garage	Zone UG Garage	NA	NA
Source Air From	NA	NA	Zone UG Garage	NA	NA	
Recirculation Loops	Number of Loops	1	1.00	1	1.00	1
	Loop Insulation Thickness	2	2	2	2	2
	Loop Location	Conditioned	Conditioned	Conditioned	Conditioned	Conditioned

Table 212: Modifications Made to Standard Design in HighRiseMixedUse Prototype to Simulate Proposed Code Change – All Climate Zones

Objects Modified	Parameter Name	Standard Design Parameter Value	Proposed Design Parameter Value 1	Proposed Design Parameter Value 2	Proposed Design Parameter Value 3	Proposed Design Parameter Value 4
DHW System Data	Configuration	SP Primary with ERWH in series for TMS	SP Primary with ERWH in series for TMS	SP Return to Primary	MP Return to Primary	SP Primary with MP in parallel for TMS
	Central / Recirculation	Central with Recirculation	Central with Recirculation	Central with Recirculation	Central with Recirculation	Central with Recirculation
	Central Type	HPWH	HPWH	HPWH	HPWH	HPWH
	Dwelling Unit Distribution	Standard	Standard	Standard	Standard	Standard
	Recirc Pump Power	96	96	96	96	96
Central HPWH	Central HPWH Primary System Type	Single Pass Primary	Single Pass Primary	Single Pass Primary	Single Pass Primary	Multi Pass Primary
	HPWH/Compressor Model	Colmac CxA-20 (41kW cap @ 40F)	Sanden GS3-45HPA-US (4kW cap @40F)	Sanden GS3-45HPA-US (4kW cap @40F)	Colmac CxA-20 (41kW cap @ 40F)	Colmac CxA-20 (MP, 41kW cap @ 40F)
	Compressor/Heater Count	3	13	11	3	3
	Total Tank Vol	930	930	830	1,000	1,269
	Tank Count	2	2	2	2	3
	Tank R-Value	R-16	R-16	R-16	R-16	R-16
	Tank Location	Zone UG Garage	Zone UG Garage	Zone UG Garage	Zone UG Garage	Zone UG Garage
	Source Air From	Zone UG Garage	Zone UG Garage	Zone UG Garage	Zone UG Garage	Zone UG Garage
	Secondary Tank Type	Series (Swing)	Series (Swing)	Parallel	None (return to Primary)	None (return to Primary)
	Secondary Tank Type	Electric Resistance	Electric Resistance	Multi Pass Primary	NA	NA
	HPWH/Compressor Model	NA	NA	Colmac CxV-5 (MP, 14kW cap @ 40F)	NA	NA
	Heater Count	2	2	4	NA	NA
	Total Tank Vol	300	300	238	NA	NA
	Tank Count	2	2	2	NA	NA
	Tank R-Value	R-16	R-16	R-16	NA	NA
	Tank Location	Zone UG Garage	Zone UG Garage	Zone UG Garage	NA	NA
	Source Air From	NA	NA	Zone UG Garage	NA	NA
Recirculation Loops	Number of Loops	1	1	1	1	1
	Loop Insulation Thickness	2	2	2	2	2
	Loop Location	Conditioned	Conditioned	Conditioned	Conditioned	Conditioned

CBECC calculates whole-building energy consumption for every hour of the year measured in kilowatt-hours per year (kWh/yr) and therms per year (therms/yr). It then applies the 2025 LSC hourly factors to calculate LSC in 2026 present value dollars (2026 PV\$), Source Energy hourly factors to calculate source energy use in kilo British thermal units per year (kBtu/yr), and hourly GHG emissions factors to calculate annual GHG emissions (metric tons of carbon dioxide emissions equivalent per year (MT or “tonnes” CO₂e/yr). CBECC also calculates annual peak electricity demand measured in kilowatts (kW).

The energy impacts of the proposed code change do vary by climate zone. The Statewide CASE Team simulated the energy impacts in every climate zone and applied the climate-zone specific LSC hourly factors when calculating energy and energy cost impacts.

Per-unit energy impacts for multifamily buildings are presented in savings per residential unit. Annual energy and peak demand impacts for each prototype building were translated into impacts per dwelling unit by dividing by the number of dwelling units in the prototype building. This step enables a calculation of statewide savings using the construction forecast that is published in terms of number of multifamily dwelling units by climate zone.

7.3.1.3 Statewide Energy Savings Methodology

The per-unit energy impacts were extrapolated to statewide impacts using the Statewide Construction Forecasts that the CEC provided. The Statewide Construction Forecasts estimate new construction/additions that would occur in 2026, the first year that the 2025 Title 24, Part 6 requirements are in effect (California Energy Commission 2022). They also estimate the amount of total existing building stock in 2026, which the Statewide CASE Team used to approximate savings from building alterations. The construction forecast provides construction (new construction/additions and existing building stock) by building type and climate zone, as shown in Appendix A.

Appendix A presents additional information about the methodology and assumptions used to calculate statewide energy impacts.

7.3.2 Per-Unit Energy Impacts Results

Energy savings and peak demand reductions per unit are presented in Table 213 through Table 232. The presented savings are from new construction. The per-unit energy savings figures do not account for naturally occurring market adoption or compliance rates.

7.3.2.1 Central HPWH_SPST

For LowRiseGarden, per-unit annual savings are expected to range from 207 to 417 kWh/yr depending upon climate zones. Per-unit annual natural gas usage increased 34 therms/yr in Climate Zone 16. There is no gas usage in all other climate zones for both base case and proposed case. Demand reductions are expected to range between -2 kW and 12 kW depending on climate zone.

For LoadedCorridor, per-unit annual savings are expected to range from 162 to 412 kWh/yr depending upon climate zones. Per-unit annual natural gas usage increased 5 therms/yr in Climate Zone 16. There is no gas usage in all other climate zones for both base case and proposed case. Demand reductions are expected to range between 26 kW and 37 kW depending on climate zone.

For MidRiseMixedUse, per-unit annual savings are expected to range from 204 to 674 kWh/yr depending upon climate zone. Per-unit annual natural gas usage increased 2 and 8 therms/yr in Climate Zone 1 and 16. There is no gas usage in all other climate zones for both base case and proposed case. Demand reductions/increases are expected to range between 7 kW and 31 kW depending on climate zone.

For HighRiseMixedUse, per-unit annual savings are expected to range from 166 to 591 kWh/yr depending upon climate zone. Per-unit annual natural gas usage increased 2 and 4 therms/yr in Climate Zone 1 and 16. There is no gas usage in all other climate zones for both base case and proposed case. Demand reductions/increases are expected to range between 3 kW and 23 kW depending on climate zone.

The per-unit savings for each prototype with Central HPWH_SPST measure are summarized in Table 213 through Table 217.

Please note that there is gas increase/decrease in 6 for LowRiseGarden and LoadedCorridor and 6 for MidRiseMixedUse and HighRiseMixedUse. It is because for LowRiseGarden and LoadedCorridor, the residential dwelling unit HVAC system uses SZAC + Furnace for 6 according to the 2022 energy code. For MidRiseMixedUse and HighRiseMixedUse, the residential dwelling unit HVAC system uses single zone dual-fuel heat pump for 6 based on the 2022 energy code. Therefore, there are gas consumption in these cases. With the HPWH tanks located in the conditioned zones, the heat transfer between the storage tanks and indoor air would slightly be different due to storage tank temperatures of different Central HPWH models. This explanation also applies to all other measures.

Table 213: Annual Electricity Savings (kWh) Per Dwelling Unit by Climate Zone (CZ) - Central – HPWH_SPST

Prototype	CZ 1	CZ 2	CZ 3	CZ 4	CZ 5	CZ 6	CZ 7	CZ 8	CZ 9	CZ 10	CZ 11	CZ 12	CZ 13	CZ 14	CZ 15	CZ 16
LowRiseGarden	417	386	382	359	384	339	335	314	317	306	316	348	301	313	207	407
LoadedCorridor	412	362	354	330	358	298	291	271	275	264	281	316	267	287	162	388
MidRiseMixedUse	492	440	432	402	437	376	367	344	350	337	348	388	328	362	204	674
HighRiseMixedUse	433	373	355	336	358	301	293	276	281	270	296	327	272	312	166	591

Table 214: Annual Peak Demand Reduction (kW) Per Dwelling Unit by Climate Zone (CZ) - Central - HPWH_SPST

Prototype	CZ 1	CZ 2	CZ 3	CZ 4	CZ 5	CZ 6	CZ 7	CZ 8	CZ 9	CZ 10	CZ 11	CZ 12	CZ 13	CZ 14	CZ 15	CZ 16
LowRiseGarden	(2)	0	6	1	7	11	11	12	12	7	(1)	4	1	(2)	5	(2)
LoadedCorridor	26	31	32	36	31	34	35	36	33	34	31	32	34	31	37	29
MidRiseMixedUse	7	13	13	15	14	23	24	20	21	20	14	15	18	15	31	25
HighRiseMixedUse	7	8	9	3	10	14	15	15	16	16	10	7	10	12	18	23

Table 215: Annual Natural Gas Savings (kBtu) Per Dwelling Unit by Climate Zone (CZ) - Central - HPWH_SPST

Prototype	CZ 1	CZ 2	CZ 3	CZ 4	CZ 5	CZ 6	CZ 7	CZ 8	CZ 9	CZ 10	CZ 11	CZ 12	CZ 13	CZ 14	CZ 15	CZ 16
LowRiseGarden	-	-	-	-	-	-	-	-	-	-	-	-	-	-	-	(34)
LoadedCorridor	-	-	-	-	-	-	-	-	-	-	-	-	-	-	-	(5)
MidRiseMixedUse	(2)	-	-	-	-	-	-	-	-	-	-	-	-	-	-	(8)
HighRiseMixedUse	(2)	-	-	-	-	-	-	-	-	-	-	-	-	-	-	(4)

Table 216: Annual Source Energy Savings (kBtu) Per Dwelling Unit by Climate Zone (CZ) - Central - HPWH_SPST

Prototype	CZ 1	CZ 2	CZ 3	CZ 4	CZ 5	CZ 6	CZ 7	CZ 8	CZ 9	CZ 10	CZ 11	CZ 12	CZ 13	CZ 14	CZ 15	CZ 16
LowRiseGarden	572	597	589	582	597	574	573	566	561	557	558	580	541	550	475	554
LoadedCorridor	759	692	666	652	673	554	542	526	539	526	586	629	557	602	383	716
MidRiseMixedUse	830	791	765	734	772	688	664	641	652	636	662	708	626	720	458	1375
HighRiseMixedUse	717	631	617	563	618	527	513	487	497	480	551	577	500	593	339	1166

Table 217: 30-year LSC Savings Cost Savings (2026 PV\$) Per Dwelling Unit by Climate Zone (CZ) - Central - HPWH_SPST

Prototype	CZ 1	CZ 2	CZ 3	CZ 4	CZ 5	CZ 6	CZ 7	CZ 8	CZ 9	CZ 10	CZ 11	CZ 12	CZ 13	CZ 14	CZ 15	CZ 16
LowRiseGarden	2808	2660	2601	2372	2626	2286	2368	2138	2129	2067	2098	2341	2005	2070	1463	2715
LoadedCorridor	2872	2604	2498	2203	2459	2027	2044	1832	1858	1795	1882	2093	1795	1959	1168	2701
MidRiseMixedUse	3280	3013	2922	2580	2923	2479	2500	2231	2265	2176	2204	2510	2084	2336	1385	4686
HighRiseMixedUse	2812	2467	2361	2062	2355	1933	1983	1742	1772	1694	1803	2016	1650	1963	1048	4053

7.3.2.2 Central HPWH_SPRetP

For LowRiseGarden, per-unit annual savings are expected to range from 67 to 117 kWh/yr depending upon climate zones. Per-unit annual natural gas usage increased 70 therms/yr in Climate Zone 16. There is no gas usage in all other climate zones for both base case and proposed case. Demand reductions are expected to range between 4 kW and 13 kW depending on climate zone.

For LoadedCorridor, per-unit annual savings are expected to range from 9 to 32 kWh/yr depending upon climate zones. Per-unit annual natural gas usage decreased 2 therms/yr in Climate Zone 16. There is no gas usage in all other climate zones for both base case and proposed case. Demand reductions are expected to range between 3 kW and 9 kW depending on climate zone.

For MidRiseMixedUse, per-unit annual savings are expected to range from 3 to 27 kWh/yr depending upon climate zone. Per-unit annual natural gas usage decreased 0.02 therms/yr in Climate Zone 1. There is no gas usage in all other climate zones for both base case and proposed case. Demand reductions are expected to range between -2 kW and 7 kW depending on climate zone.

For HighRiseMixedUse, per-unit annual savings are expected to range from -7 to 9 kWh/yr depending upon climate zone. Per-unit annual natural gas usage increased 0.09 therms/yr in Climate Zone 16. There is no gas usage in all other climate zones for both base case and proposed case. Demand reductions are expected to range between -8 kW and -1 kW depending on climate zone.

The per-unit savings for each prototype with Central HPWH_SPRetP measure are summarized in Table 218 through Table 222.

Table 218: Annual Electricity Savings (kWh) Per Dwelling Unit - Central - HPWH_SPRetP

Prototype	CZ 1	CZ 2	CZ 3	CZ 4	CZ 5	CZ 6	CZ 7	CZ 8	CZ 9	CZ 10	CZ 11	CZ 12	CZ 13	CZ 14	CZ 15	CZ 16
LowRiseGarden	67	76	79	79	77	91	93	95	93	94	90	84	93	87	117	77
LoadedCorridor	9	13	15	16	14	20	21	21	21	21	20	17	21	19	32	10
MidRiseMixedUse	12	14	16	17	16	18	19	19	19	20	18	17	20	15	27	3
HighRiseMixedUse	0	3	6	3	5	6	6	7	6	7	5	5	6	1	9	(7)

Table 219: Annual Peak Demand Reduction (kW) Per Dwelling Unit - Central - HPWH_SPRetP

Prototype	CZ 1	CZ 2	CZ 3	CZ 4	CZ 5	CZ 6	CZ 7	CZ 8	CZ 9	CZ 10	CZ 11	CZ 12	CZ 13	CZ 14	CZ 15	CZ 16
LowRiseGarden	6	5	9	7	8	9	11	9	9	8	6	7	8	6	13	4
LoadedCorridor	5	5	6	8	7	7	7	9	7	8	5	6	8	5	9	3
MidRiseMixedUse	0	4	4	3	4	4	4	4	5	5	4	6	6	(1)	7	(2)
HighRiseMixedUse	(4)	(4)	(3)	(5)	(1)	(3)	(3)	(4)	(3)	(2)	(8)	(4)	(6)	(8)	(1)	(7)

Table 220: Annual Natural Gas Savings (kBtu) Per Dwelling Unit - Central - HPWH_SPRetP

Prototype	CZ 1	CZ 2	CZ 3	CZ 4	CZ 5	CZ 6	CZ 7	CZ 8	CZ 9	CZ 10	CZ 11	CZ 12	CZ 13	CZ 14	CZ 15	CZ 16
LowRiseGarden	0	0	0	0	0	0	0	0	0	0	0	0	0	0	0	(70)
LoadedCorridor	0	0	0	0	0	0	0	0	0	0	0	0	0	0	0	2
MidRiseMixedUse	(0)	0	0	0	0	0	0	0	0	0	0	0	0	0	0	0
HighRiseMixedUse	0	0	0	0	0	0	0	0	0	0	0	0	0	0	0	(0)

Table 221: Annual Source Energy Savings (kBtu) Per Dwelling Unit - Central - HPWH_SPRetP

Prototype	CZ 1	CZ 2	CZ 3	CZ 4	CZ 5	CZ 6	CZ 7	CZ 8	CZ 9	CZ 10	CZ 11	CZ 12	CZ 13	CZ 14	CZ 15	CZ 16
LowRiseGarden	171	187	201	189	193	221	229	224	219	221	206	196	212	198	258	130
LoadedCorridor	58	62	65	67	63	74	73	74	74	74	71	68	72	68	88	54
MidRiseMixedUse	28	44	57	46	57	58	56	56	56	57	42	45	53	23	70	12
HighRiseMixedUse	(9)	(3)	10	(4)	8	12	14	14	15	15	(5)	5	12	(22)	23	(31)

Table 222: 30-year LSC Savings Cost Savings (2026 PV\$) Per Dwelling Unit - Central - HPWH_SPRetP

Prototype	CZ 1	CZ 2	CZ 3	CZ 4	CZ 5	CZ 6	CZ 7	CZ 8	CZ 9	CZ 10	CZ 11	CZ 12	CZ 13	CZ 14	CZ 15	CZ 16
LowRiseGarden	491	549	602	548	568	666	687	684	665	671	611	593	636	616	839	487
LoadedCorridor	82	116	127	121	111	159	146	173	173	176	144	123	166	151	243	87
MidRiseMixedUse	64	103	123	94	91	136	106	143	147	148	104	116	125	78	197	15
HighRiseMixedUse	(16)	(3)	1	(12)	26	21	(21)	26	34	32	(8)	14	18	(25)	56	(88)

7.3.2.3 Central HPWH_MPRetP

For LowRiseGarden, per-unit increased electricity use for the annual range from 93 to 295 kWh/yr depending upon climate zones. Per-unit annual natural gas usage increased 60 therms/yr in Climate Zone 16. There is no gas usage in all other climate zones for both base case and proposed case. Demand increases are expected to range between 7 kW and 21 kW depending on climate zone.

For LoadedCorridor, per-unit annual savings are expected to range from 156 to 332 kWh/yr depending upon climate zones. Per-unit annual natural gas usage increased 0.81 therms/yr in Climate Zone 16. There is no gas usage in all other climate zones for both base case and proposed case. Demand increases are expected to range between 7 kW and 23 kW depending on climate zone.

For MidRiseMixedUse, per-unit annual savings are expected to range from 90 to 213 kWh/yr depending upon climate zone. Per-unit annual natural gas usage decreased 0.84 and 1.3 therms/yr in Climate Zone 1 and 16. There is no gas usage in all other climate zones for both base case and proposed case. Demand increases are expected to range between 5 kW and 15 kW depending on climate zone.

For HighRiseMixedUse, per-unit annual savings are expected to range from 83 to 174 kWh/yr depending upon climate zone. Per-unit annual natural gas usage decreased 1 and 1.23 therms/yr in Climate Zone 1 and 16. There is no gas usage in all other climate zones for both base case and proposed case. Demand increases are expected to range between 7 kW and 15 kW depending on climate zone.

Table 223: Annual Electricity Savings (kWh) Per Dwelling Unit - Central - HPWH_MPRetP

Prototype	CZ 1	CZ 2	CZ 3	CZ 4	CZ 5	CZ 6	CZ 7	CZ 8	CZ 9	CZ 10	CZ 11	CZ 12	CZ 13	CZ 14	CZ 15	CZ 16
LowRiseGarden	(295)	(245)	(232)	(219)	(235)	(175)	(168)	(156)	(164)	(156)	(180)	(206)	(165)	(188)	(93)	(284)
LoadedCorridor	(332)	(286)	(274)	(262)	(277)	(223)	(218)	(207)	(214)	(207)	(229)	(251)	(217)	(236)	(156)	(328)
MidRiseMixedUse	(213)	(185)	(181)	(170)	(183)	(152)	(148)	(141)	(142)	(138)	(148)	(165)	(142)	(150)	(90)	(173)
HighRiseMixedUse	(174)	(152)	(149)	(142)	(151)	(128)	(126)	(120)	(122)	(119)	(125)	(137)	(120)	(125)	(83)	(134)

Table 224: Annual Peak Demand Reduction (kW) Per Dwelling Unit - Central - HPWH_MPRetP

Prototype	CZ 1	CZ 2	CZ 3	CZ 4	CZ 5	CZ 6	CZ 7	CZ 8	CZ 9	CZ 10	CZ 11	CZ 12	CZ 13	CZ 14	CZ 15	CZ 16
LowRiseGarden	(21)	(21)	(15)	(18)	(15)	(11)	(11)	(12)	(13)	(14)	(17)	(17)	(14)	(19)	(7)	(21)
LoadedCorridor	(23)	(20)	(17)	(14)	(17)	(11)	(10)	(11)	(12)	(10)	(16)	(16)	(12)	(18)	(7)	(21)
MidRiseMixedUse	(15)	(10)	(11)	(9)	(11)	(10)	(10)	(8)	(8)	(8)	(10)	(8)	(7)	(12)	(5)	(11)
HighRiseMixedUse	(15)	(12)	(12)	(12)	(13)	(10)	(10)	(11)	(10)	(10)	(14)	(13)	(13)	(12)	(7)	(14)

Table 225: Annual Natural Gas Savings (kBtu) Per Dwelling Unit - Central - HPWH_MPRetP

Prototype	CZ 1	CZ 2	CZ 3	CZ 4	CZ 5	CZ 6	CZ 7	CZ 8	CZ 9	CZ 10	CZ 11	CZ 12	CZ 13	CZ 14	CZ 15	CZ 16
LowRiseGarden	0	0	0	0	0	0	0	0	0	0	0	0	0	0	0	(60)
LoadedCorridor	0	0	0	0	0	0	0	0	0	0	0	0	0	0	0	(1)
MidRiseMixedUse	1	0	0	0	0	0	0	0	0	0	0	0	0	0	0	1
HighRiseMixedUse	1	0	0	0	0	0	0	0	0	0	0	0	0	0	0	1

Table 226: Annual Source Energy Savings (kBtu) Per Dwelling Unit - Central - HPWH_MPRetP

Prototype	CZ 1	CZ 2	CZ 3	CZ 4	CZ 5	CZ 6	CZ 7	CZ 8	CZ 9	CZ 10	CZ 11	CZ 12	CZ 13	CZ 14	CZ 15	CZ 16
LowRiseGarden	(440)	(385)	(337)	(349)	(344)	(228)	(211)	(213)	(235)	(224)	(300)	(326)	(261)	(325)	(128)	(501)
LoadedCorridor	(506)	(455)	(414)	(421)	(420)	(322)	(311)	(308)	(323)	(318)	(381)	(408)	(356)	(404)	(246)	(528)
MidRiseMixedUse	(346)	(321)	(308)	(304)	(309)	(251)	(249)	(244)	(251)	(242)	(256)	(292)	(247)	(274)	(160)	(253)
HighRiseMixedUse	(283)	(267)	(256)	(256)	(258)	(216)	(208)	(197)	(204)	(200)	(213)	(237)	(210)	(223)	(142)	(190)

Table 227: 30-year LSC Savings Cost Savings (2026 PV\$) Per Dwelling Unit - Central - HPWH_MPRetP

Prototype	CZ 1	CZ 2	CZ 3	CZ 4	CZ 5	CZ 6	CZ 7	CZ 8	CZ 9	CZ 10	CZ 11	CZ 12	CZ 13	CZ 14	CZ 15	CZ 16
LowRiseGarden	(2022)	(1711)	(1611)	(1514)	(1591)	(1154)	(1106)	(1040)	(1099)	(1050)	(1251)	(1404)	(1150)	(1288)	(696)	(2031)
LoadedCorridor	(2240)	(1955)	(1852)	(1748)	(1863)	(1449)	(1449)	(1348)	(1393)	(1349)	(1537)	(1691)	(1443)	(1564)	(1066)	(2208)
MidRiseMixedUse	(1469)	(1331)	(1257)	(1174)	(1310)	(1030)	(1041)	(936)	(947)	(920)	(1005)	(1130)	(958)	(1004)	(593)	(1142)
HighRiseMixedUse	(1175)	(1061)	(1029)	(977)	(1052)	(879)	(886)	(796)	(804)	(794)	(845)	(918)	(812)	(837)	(543)	(866)

7.3.2.4 Central HPWH_SPwMPTM

For MidRiseMixedUse, per-unit annual savings are expected to range from 206 to 671 kWh/yr depending upon climate zone. Per-unit annual natural gas usage increased 2 and 7 therms/yr in Climate Zone 1 and 16. There is no gas usage in all other climate zones for both base case and proposed case. Demand reductions are expected to range between -6 kW and 14 kW depending on climate zone.

For HighRiseMixedUse, per-unit annual savings are expected to range from 154 to 564 kWh/yr depending upon climate zone. Per-unit annual natural gas usage increased 2 and 4 therms/yr in Climate Zone 1 and 16. There is no gas usage in all other climate zones for both base case and proposed case. Demand reductions are expected to range between -3 kW and 11 kW depending on climate zone.

Table 228: Annual Electricity Savings (kWh) Per Dwelling Unit - Central - HPWH_SPwMPTM

Prototype	CZ 1	CZ 2	CZ 3	CZ 4	CZ 5	CZ 6	CZ 7	CZ 8	CZ 9	CZ 10	CZ 11	CZ 12	CZ 13	CZ 14	CZ 15	CZ 16
MidRiseMixedUse	486	426	417	390	420	361	353	332	337	326	340	377	321	352	206	671
HighRiseMixedUse	407	350	334	316	337	284	277	260	264	253	278	308	254	293	154	564

Table 229: Annual Peak Demand Reduction (kW) Per Dwelling Unit - Central - HPWH_SPwMPTM

Prototype	CZ 1	CZ 2	CZ 3	CZ 4	CZ 5	CZ 6	CZ 7	CZ 8	CZ 9	CZ 10	CZ 11	CZ 12	CZ 13	CZ 14	CZ 15	CZ 16
MidRiseMixedUse	(6)	(3)	(2)	(3)	(1)	0	1	(0)	1	(0)	(5)	(1)	(4)	(2)	1	14
HighRiseMixedUse	(1)	(1)	1	(2)	4	3	4	2	3	2	(2)	1	(3)	2	11	9

Table 230: Annual Natural Gas Savings (kBtu) Per Dwelling Unit - Central - HPWH_SPwMPTM

Prototype	CZ 1	CZ 2	CZ 3	CZ 4	CZ 5	CZ 6	CZ 7	CZ 8	CZ 9	CZ 10	CZ 11	CZ 12	CZ 13	CZ 14	CZ 15	CZ 16
MidRiseMixedUse	(2)	0	0	0	0	0	0	0	0	0	0	0	0	0	0	(7)
HighRiseMixedUse	(2)	0	0	0	0	0	0	0	0	0	0	0	0	0	0	(4)

Table 231: Annual Source Energy Savings (kBtu) Per Dwelling Unit - Central - HPWH_SPwMPTM

Prototype	CZ 1	CZ 2	CZ 3	CZ 4	CZ 5	CZ 6	CZ 7	CZ 8	CZ 9	CZ 10	CZ 11	CZ 12	CZ 13	CZ 14	CZ 15	CZ 16
MidRiseMixedUse	638	651	630	633	628	595	575	573	579	570	581	611	554	641	435	1223
HighRiseMixedUse	631	568	557	503	559	479	465	447	456	441	496	518	448	539	313	1093

Table 232: 30-year LSC Savings (2026 PV\$) Per Dwelling Unit - Central - HPWH_SPwMPTM

Prototype	CZ 1	CZ 2	CZ 3	CZ 4	CZ 5	CZ 6	CZ 7	CZ 8	CZ 9	CZ 10	CZ 11	CZ 12	CZ 13	CZ 14	CZ 15	CZ 16
MidRiseMixedUse	3087	2840	2742	2472	2738	2278	2271	2084	2111	2038	2119	2397	1999	2214	1334	4527
HighRiseMixedUse	2609	2280	2180	1928	2210	1783	1794	1618	1641	1566	1691	1898	1548	1828	966	3832

7.3.2.5 System Performance

The Statewide CASE Team evaluated the SysCOP for comparison with NEEA AWHs Tiers. Figure 17 presented annual SysCOP estimation from CBECC simulation for Climate Zone 12. The SysCOP for all configurations are above NEEA Tier 2 requirements, which has a COP of 2.0.

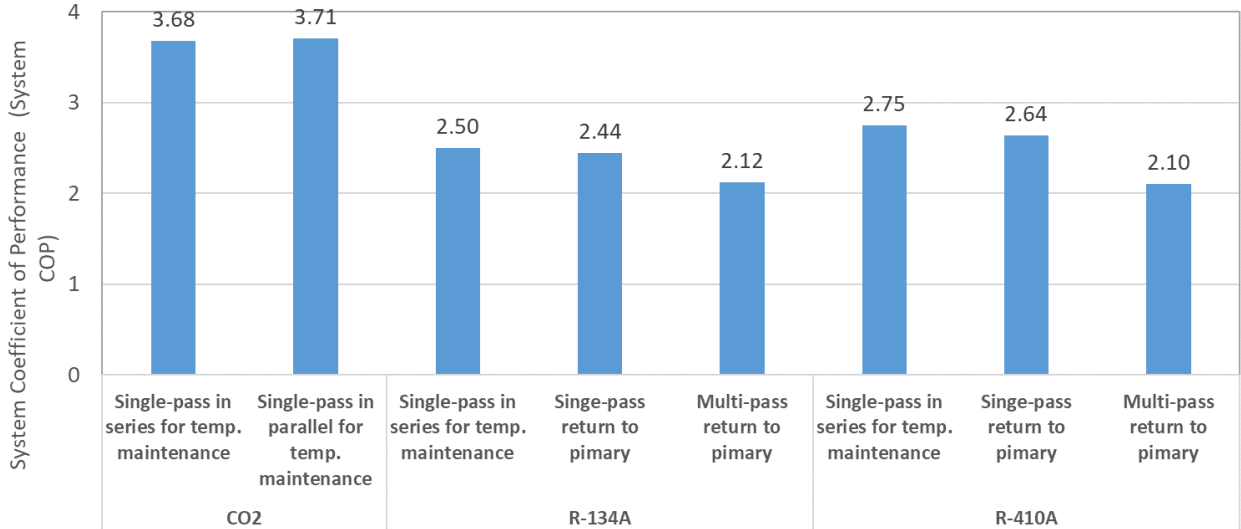

Figure 17: Example of annual HPWH SysCOP - Climate Zone 12.

Comparing the various plumbing configurations:

- Single-pass primary with electric resistance water heater in series for temperature maintenance system is efficient. With this configuration, the high efficiency single-pass primary HPWH can provide partial temperature maintenance load. It uses electric resistance for part of the load to maintain the hot water in the recirculation loop.
- The single-pass primary with multi-pass in parallel for temperature maintenance system has similar efficiency since it uses heat pumps for both primary and temperature maintenance load loops. The multi-pass heat pumps in the recirculation loop provide full temperature maintenance load. These system types are mostly applicable for multifamily buildings with four or more habitable stories because of the complexity of the design and associated cost.
- The multi-pass return to primary systems are less efficient compared to single-pass return to primary since the multi-pass HPWH has a lower temperature lift.

In addition to simulation, the Statewide CASE Team reviewed lab testing results and field performance data to evaluate energy use of different central HPWP equipment and design approaches. Note that lab testing data are only for SysCOP with ambient air temperature at constant temperature at 67°F, see Figure 18. It is not possible to directly

compare lab test data with field performance or simulation results because the system performance can vary significantly due to hot water draw profiles, equipment sizing, and distribution loop efficiency. Still, the lab testing data mostly align well with simulation results, except that lab data shows single-pass return to primary configurations are most efficient, because the highly efficient single-pass HPWH provide all hot water load. However, as discussed in Section 7.2.2, this plumbing configuration may not be the most reliable in real-world applications and some single-pass manufacturers do not support this design.

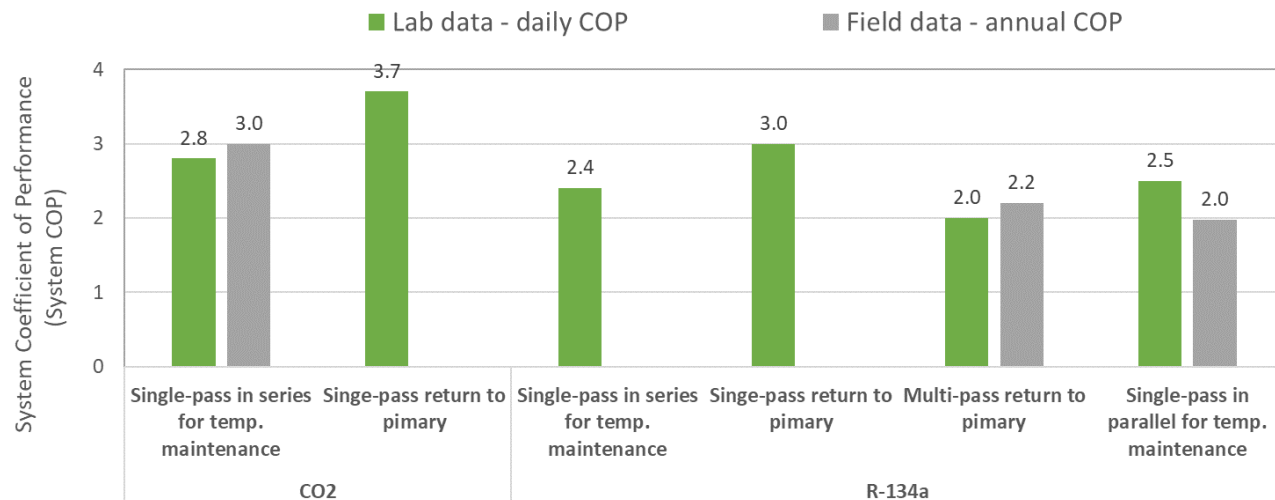

Figure 18: System COP for various HPWH configurations from lab test and real-world projects.

7.4 Cost and Cost-Effectiveness

7.4.1 Energy Cost Savings Methodology

Energy cost savings were calculated by applying the LSC hourly factors to the energy savings estimates that were derived using the methodology described in Section 7.3.1. LSC hourly factors are a normalized metric to calculate energy cost savings that accounts for the variable cost of electricity and natural gas for each hour of the year, along with how costs are expected to change over the 30-year period of analysis.

The CEC requested LSC savings over the 30-year period of analysis in both 2026 PV\$ and nominal dollars. The cost-effectiveness analysis uses LSC values in 2026 PV\$. Costs and cost-Effectiveness using 2026 PV\$ are presented in Section 7.4.5 of this report. The CEC uses results in nominal dollars to complete the Economic and Fiscal Impacts Statement (From 399) for the entire package of proposed change to Title 24, Part 6. Appendix G: Energy Cost Savings in Nominal Dollars presents LSC savings results in nominal dollars.

The proposed code change does not apply to additions and/or alterations.

7.4.2 Energy Cost Savings Results

Per-unit energy cost savings for newly constructed buildings in terms of LSC savings realized over the 30-year period of analysis are presented 2026 PV\$ in Table 233 through Table 250.

The LSC methodology allows peak electricity savings to be valued more than electricity savings during non-peak periods.

Any time code changes impact cost, there is potential to disproportionately impact DIPs. Refer to Section 7.6 for more details addressing energy equity and environmental justice.

Table 233: 2026 PV 30-year LSC Savings – New Construction and Additions – Central HPWH - HPWH_SPST – LowRiseGarden

Climate Zone	30-Year LSC Electricity Savings (2026 PV \$)	30-Year LSC Gas Savings (2026 PV \$)	Total 30-Year LSC Savings (2026 PV \$)
1	\$2,808	\$0	\$2,808
2	\$2,660	\$0	\$2,660
3	\$2,601	\$0	\$2,601
4	\$2,372	\$0	\$2,372
5	\$2,626	\$0	\$2,626
6	\$2,286	\$0	\$2,286
7	\$2,368	\$0	\$2,368
8	\$2,138	\$0	\$2,138
9	\$2,129	\$0	\$2,129
10	\$2,067	\$0	\$2,067
11	\$2,098	\$0	\$2,098
12	\$2,341	\$0	\$2,341
13	\$2,005	\$0	\$2,005
14	\$2,070	\$0	\$2,070
15	\$1,463	\$0	\$1,463
16	\$2,760	(\$44)	\$2,715
Total	\$2,272	(\$0.16)	\$2,272

Table 234: 2026 Present Value LSC Savings Per Dwelling Unit Over 30-Year Period of Analysis – New Construction & Additions – Central HPWH - HPWH_SPST – LoadedCorridor

Climate Zone	30-Year LSC Electricity Savings (2026 PV \$)	30-Year LSC Gas Savings (2026 PV \$)	Total 30-Year LSC Savings (2026 PV \$)
1	\$2,872	\$0	\$2,872
2	\$2,604	\$0	\$2,604
3	\$2,498	\$0	\$2,498
4	\$2,203	\$0	\$2,203
5	\$2,459	\$0	\$2,459
6	\$2,027	\$0	\$2,027
7	\$2,044	\$0	\$2,044
8	\$1,832	\$0	\$1,832
9	\$1,858	\$0	\$1,858
10	\$1,795	\$0	\$1,795
11	\$1,882	\$0	\$1,882
12	\$2,093	\$0	\$2,093
13	\$1,795	\$0	\$1,795
14	\$1,959	\$0	\$1,959
15	\$1,168	\$0	\$1,168
16	\$2,708	(\$6)	\$2,701
Total	\$2,039	(\$0.02)	\$2,039

Table 235: 2026 Present Value LSC Savings Per Dwelling Unit Over 30-Year Period of Analysis – New Construction & Additions – Central HPWH - HPWH_SPST – MidRiseMixedUse

Climate Zone	30-Year LSC Electricity Savings (2026 PV \$)	30-Year LSC Gas Savings (2026 PV \$)	Total 30-Year LSC Savings (2026 PV \$)
1	\$3,282	\$0	\$3,282
2	\$3,013	\$0	\$3,013
3	\$2,922	\$0	\$2,922
4	\$2,580	\$0	\$2,580
5	\$2,923	\$0	\$2,923
6	\$2,479	\$0	\$2,479
7	\$2,500	\$0	\$2,500
8	\$2,231	\$0	\$2,231
9	\$2,265	\$0	\$2,265
10	\$2,176	\$0	\$2,176
11	\$2,204	\$0	\$2,204
12	\$2,510	\$0	\$2,510
13	\$2,084	\$0	\$2,084
14	\$2,336	\$0	\$2,336
15	\$1,385	\$0	\$1,385
16	\$4,696	(\$9)	\$4,686
Total	\$2,450	(\$0.04)	\$2,450

Table 236: 2026 Present Value LSC Savings Per Dwelling Unit Over 30-Year Period of Analysis – New Construction & Additions – Central HPWH - HPWH_SPST – HighRiseMixedUse

Climate Zone	30-Year LSC Electricity Savings (2026 PV \$)	30-Year LSC Gas Savings (2026 PV \$)	Total 30-Year LSC Savings (2026 PV \$)
1	\$2,814	\$0	\$2,814
2	\$2,467	\$0	\$2,467
3	\$2,361	\$0	\$2,361
4	\$2,062	\$0	\$2,062
5	\$2,355	\$0	\$2,355
6	\$1,933	\$0	\$1,933
7	\$1,983	\$0	\$1,983
8	\$1,742	\$0	\$1,742
9	\$1,772	\$0	\$1,772
10	\$1,694	\$0	\$1,694
11	\$1,803	\$0	\$1,803
12	\$2,016	\$0	\$2,016
13	\$1,650	\$0	\$1,650
14	\$1,963	\$0	\$1,963
15	\$1,048	\$0	\$1,048
16	\$4,058	(\$5)	\$4,053
Total	\$1,948	(\$0.02)	\$1,948

Table 237: 2026 Present Value LSC Savings Per Dwelling Unit Over 30-Year Period of Analysis – New Construction & Additions – Central HPWH - HPWH_MPRetP – LowRiseGarden

Climate Zone	30-Year LSC Electricity Savings (2026 PV \$)	30-Year LSC Gas Savings (2026 PV \$)	Total 30-Year LSC Savings (2026 PV \$)
1	(\$2,022)	\$0	(\$2,022)
2	(\$1,711)	\$0	(\$1,711)
3	(\$1,611)	\$0	(\$1,611)
4	(\$1,514)	\$0	(\$1,514)
5	(\$1,591)	\$0	(\$1,591)
6	(\$1,154)	\$0	(\$1,154)
7	(\$1,106)	\$0	(\$1,106)
8	(\$1,040)	\$0	(\$1,040)
9	(\$1,099)	\$0	(\$1,099)
10	(\$1,050)	\$0	(\$1,050)
11	(\$1,251)	\$0	(\$1,251)
12	(\$1,404)	\$0	(\$1,404)
13	(\$1,150)	\$0	(\$1,150)
14	(\$1,288)	\$0	(\$1,288)
15	(\$696)	\$0	(\$696)
16	(\$1,954)	(\$77)	(\$2,031)
Total	(\$1,251)	(\$0.27)	(\$1,252)

Table 238: 2026 Present Value LSC Savings Per Dwelling Unit Over 30-Year Period of Analysis – New Construction & Additions – Central HPWH - HPWH_MPRetP – LoadedCorridor

Climate Zone	30-Year LSC Electricity Savings (2026 PV \$)	30-Year LSC Gas Savings (2026 PV \$)	Total 30-Year LSC Savings (2026 PV \$)
1	(\$2,240)	\$0	(\$2,240)
2	(\$1,955)	\$0	(\$1,955)
3	(\$1,852)	\$0	(\$1,852)
4	(\$1,748)	\$0	(\$1,748)
5	(\$1,863)	\$0	(\$1,863)
6	(\$1,449)	\$0	(\$1,449)
7	(\$1,449)	\$0	(\$1,449)
8	(\$1,348)	\$0	(\$1,348)
9	(\$1,393)	\$0	(\$1,393)
10	(\$1,349)	\$0	(\$1,349)
11	(\$1,537)	\$0	(\$1,537)
12	(\$1,691)	\$0	(\$1,691)
13	(\$1,443)	\$0	(\$1,443)
14	(\$1,564)	\$0	(\$1,564)
15	(\$1,066)	\$0	(\$1,066)
16	(\$2,207)	(\$1)	(\$2,208)
Total	(\$1,539)	(\$0.004)	(\$1,539)

Table 239: 2026 Present Value LSC Savings Per Dwelling Unit Over 30-Year Period of Analysis – New Construction & Additions – Central HPWH - HPWH_ MPRetP – MidRiseMixedUse

Climate Zone	30-Year LSC Electricity Savings (2026 PV \$)	30-Year LSC Gas Savings (2026 PV \$)	Total 30-Year LSC Savings (2026 PV \$)
1	(\$1,470)	\$0	(\$1,470)
2	(\$1,331)	\$0	(\$1,331)
3	(\$1,257)	\$0	(\$1,257)
4	(\$1,174)	\$0	(\$1,174)
5	(\$1,310)	\$0	(\$1,310)
6	(\$1,030)	\$0	(\$1,030)
7	(\$1,041)	\$0	(\$1,041)
8	(\$936)	\$0	(\$936)
9	(\$947)	\$0	(\$947)
10	(\$920)	\$0	(\$920)
11	(\$1,005)	\$0	(\$1,005)
12	(\$1,130)	\$0	(\$1,130)
13	(\$958)	\$0	(\$958)
14	(\$1,004)	\$0	(\$1,004)
15	(\$593)	\$0	(\$593)
16	(\$1,143)	\$2	(\$1,142)
Total	(\$1,049)	\$0.01	(\$1,049)

Table 240: 2026 Present Value LSC Savings Per Dwelling Unit Over 30-Year Period of Analysis – New Construction & Additions – Central HPWH - HPWH_ MPRetP – HighRiseMixedUse

Climate Zone	30-Year LSC Electricity Savings (2026 PV \$)	30-Year LSC Gas Savings (2026 PV \$)	Total 30-Year LSC Savings (2026 PV \$)
1	(\$1,176)	\$0	(\$1,176)
2	(\$1,061)	\$0	(\$1,061)
3	(\$1,029)	\$0	(\$1,029)
4	(\$977)	\$0	(\$977)
5	(\$1,052)	\$0	(\$1,052)
6	(\$879)	\$0	(\$879)
7	(\$886)	\$0	(\$886)
8	(\$796)	\$0	(\$796)
9	(\$804)	\$0	(\$804)
10	(\$794)	\$0	(\$794)
11	(\$845)	\$0	(\$845)
12	(\$918)	\$0	(\$918)
13	(\$812)	\$0	(\$812)
14	(\$837)	\$0	(\$837)
15	(\$543)	\$0	(\$543)
16	(\$868)	\$2	(\$866)
Total	(\$878)	\$0.01	(\$878)

Table 241: 2026 Present Value LSC Savings Per Dwelling Unit Over 30-Year Period of Analysis – New Construction & Additions – Central HPWH - HPWH_SPRetP – LowRiseGarden

Climate Zone	30-Year LSC Electricity Savings (2026 PV \$)	30-Year LSC Gas Savings (2026 PV \$)	Total 30-Year LSC Savings (2026 PV \$)
1	\$491	\$0	\$491
2	\$549	\$0	\$549
3	\$602	\$0	\$602
4	\$548	\$0	\$548
5	\$568	\$0	\$568
6	\$666	\$0	\$666
7	\$687	\$0	\$687
8	\$684	\$0	\$684
9	\$665	\$0	\$665
10	\$671	\$0	\$671
11	\$611	\$0	\$611
12	\$593	\$0	\$593
13	\$636	\$0	\$636
14	\$616	\$0	\$616
15	\$839	\$0	\$839
16	\$577	(\$91)	\$487
Total	\$641	(\$0.32)	\$640

Table 242: 2026 Present Value LSC Savings Per Dwelling Unit Over 30-Year Period of Analysis – New Construction & Additions – Central HPWH - HPWH_SPRetP – LoadedCorridor

Climate Zone	30-Year LSC Electricity Savings (2026 PV \$)	30-Year LSC Gas Savings (2026 PV \$)	Total 30-Year LSC Savings (2026 PV \$)
1	\$82	\$0	\$82
2	\$116	\$0	\$116
3	\$127	\$0	\$127
4	\$121	\$0	\$121
5	\$111	\$0	\$111
6	\$159	\$0	\$159
7	\$146	\$0	\$146
8	\$173	\$0	\$173
9	\$173	\$0	\$173
10	\$176	\$0	\$176
11	\$144	\$0	\$144
12	\$123	\$0	\$123
13	\$166	\$0	\$166
14	\$151	\$0	\$151
15	\$243	\$0	\$243
16	\$84	\$3	\$87
Total	\$151	\$0.01	\$151

Table 243: 2026 Present Value LSC Savings Per Dwelling Unit Over 30-Year Period of Analysis – New Construction & Additions – Central HPWH - HPWH_SPRetP – MidRiseMixedUse

Climate Zone	30-Year LSC Electricity Savings (2026 PV \$)	30-Year LSC Gas Savings (2026 PV \$)	Total 30-Year LSC Savings (2026 PV \$)
1	\$64	\$0	\$64
2	\$103	\$0	\$103
3	\$123	\$0	\$123
4	\$94	\$0	\$94
5	\$91	\$0	\$91
6	\$136	\$0	\$136
7	\$106	\$0	\$106
8	\$143	\$0	\$143
9	\$147	\$0	\$147
10	\$148	\$0	\$148
11	\$104	\$0	\$104
12	\$116	\$0	\$116
13	\$125	\$0	\$125
14	\$78	\$0	\$78
15	\$197	\$0	\$197
16	\$15	\$0	\$15
Total	\$127	\$0.0001	\$127

Table 244: 2026 Present Value LSC Savings Per Dwelling Unit Over 30-Year Period of Analysis – New Construction & Additions – Central HPWH - HPWH_SPRetP – HighRiseMixedUse

Climate Zone	30-Year LSC Electricity Savings (2026 PV \$)	30-Year LSC Gas Savings (2026 PV \$)	Total 30-Year LSC Savings (2026 PV \$)
1	(\$16)	\$0	(\$16)
2	(\$3)	\$0	(\$3)
3	\$1	\$0	\$1
4	(\$12)	\$0	(\$12)
5	\$26	\$0	\$26
6	\$21	\$0	\$21
7	(\$21)	\$0	(\$21)
8	\$26	\$0	\$26
9	\$34	\$0	\$34
10	\$32	\$0	\$32
11	(\$8)	\$0	(\$8)
12	\$14	\$0	\$14
13	\$18	\$0	\$18
14	(\$25)	\$0	(\$25)
15	\$56	\$0	\$56
16	(\$87)	(\$0.12)	(\$88)
Total	\$13	\$0.00	\$13

Table 245: 2026 Present Value LSC Savings Per Dwelling Unit Over 30-Year Period of Analysis – New Construction & Additions – Central HPWH - HPWH_SPwMPTM – MidRiseMixedUse

Climate Zone	30-Year LSC Electricity Savings (2026 PV \$)	30-Year LSC Gas Savings (2026 PV \$)	Total 30-Year LSC Savings (2026 PV \$)
1	\$3,090	\$0	\$3,090
2	\$2,840	\$0	\$2,840
3	\$2,742	\$0	\$2,742
4	\$2,472	\$0	\$2,472
5	\$2,738	\$0	\$2,738
6	\$2,278	\$0	\$2,278
7	\$2,271	\$0	\$2,271
8	\$2,084	\$0	\$2,084
9	\$2,111	\$0	\$2,111
10	\$2,038	\$0	\$2,038
11	\$2,119	\$0	\$2,119
12	\$2,397	\$0	\$2,397
13	\$1,999	\$0	\$1,999
14	\$2,214	\$0	\$2,214
15	\$1,334	\$0	\$1,334
16	\$4,537	(\$9.40)	\$4,527
Total	\$2,296	(\$0.04)	\$2,296

Table 246: 2026 Present Value LSC Savings Per Dwelling Unit Over 30-Year Period of Analysis – New Construction & Additions – Central HPWH - HPWH_SPwMPTM – HighRiseMixedUse

Climate Zone	30-Year LSC Electricity Savings (2026 PV \$)	30-Year LSC Gas Savings (2026 PV \$)	Total 30-Year LSC Savings (2026 PV \$)
1	\$2,611	\$0	\$2,611
2	\$2,280	\$0	\$2,280
3	\$2,180	\$0	\$2,180
4	\$1,928	\$0	\$1,928
5	\$2,210	\$0	\$2,210
6	\$1,783	\$0	\$1,783
7	\$1,794	\$0	\$1,794
8	\$1,618	\$0	\$1,618
9	\$1,641	\$0	\$1,641
10	\$1,566	\$0	\$1,566
11	\$1,691	\$0	\$1,691
12	\$1,898	\$0	\$1,898
13	\$1,548	\$0	\$1,548
14	\$1,828	\$0	\$1,828
15	\$966	\$0	\$966
16	\$3,837	(\$4.66)	\$3,832
Total	\$1,805	(\$0.02)	\$1,805

Table 247: Average 2026 PV 30-year LSC Savings – New Construction and Additions –Central HPWH – HPWH_SPST – All Prototypes

Climate Zone	30-Year LSC Electricity Savings (2026 PV\$)	30-Year LSC Natural Gas Savings (2026 PV\$)	Total 30-Year LSC Savings (2026 PV\$)
1	\$3,100	(\$2)	\$3,098
2	\$2,832	\$0	\$2,832
3	\$2,736	\$0	\$2,736
4	\$2,417	\$0	\$2,417
5	\$2,725	\$0	\$2,725
6	\$2,291	\$0	\$2,291
7	\$2,314	\$0	\$2,314
8	\$2,068	\$0	\$2,068
9	\$2,097	\$0	\$2,097
10	\$2,018	\$0	\$2,018
11	\$2,070	\$0	\$2,070
12	\$2,337	\$0	\$2,337
13	\$1,961	\$0	\$1,961
14	\$2,179	\$0	\$2,179
15	\$1,297	\$0	\$1,297
16	\$3,922	(\$10)	\$3,912
Total	\$2,278	(\$0.04)	\$2,278

Table 248: Average 2026 PV 30-year LSC Savings – New Construction and Additions –Central HPWH – HPWH_SPRetP – All Prototypes

Climate Zone	30-Year LSC Electricity Savings (2026 PV\$)	30-Year LSC Natural Gas Savings (2026 PV\$)	Total 30-Year LSC Savings (2026 PV\$)
1	\$84	\$0	\$84
2	\$120	\$0	\$120
3	\$138	\$0	\$138
4	\$117	\$0	\$117
5	\$115	\$0	\$115
6	\$160	\$0	\$160
7	\$137	\$0	\$137
8	\$170	\$0	\$170
9	\$172	\$0	\$172
10	\$174	\$0	\$174
11	\$133	\$0	\$133
12	\$133	\$0	\$133
13	\$155	\$0	\$155
14	\$120	\$0	\$120
15	\$232	\$0	\$232
16	\$57	(\$3)	\$54
Total	\$151	(\$0.01)	\$151

Table 249: Average 2026 PV 30-year LSC Savings – New Construction and Additions –Central HPWH – HPWH_MPRetP – All Prototypes

Climate Zone	30-Year LSC Electricity Savings (2026 PV\$)	30-Year LSC Natural Gas Savings (2026 PV\$)	Total 30-Year LSC Savings (2026 PV\$)
1	(\$1,729)	\$1	(\$1,729)
2	(\$1,536)	\$0	(\$1,536)
3	(\$1,455)	\$0	(\$1,455)
4	(\$1,366)	\$0	(\$1,366)
5	(\$1,489)	\$0	(\$1,489)
6	(\$1,164)	\$0	(\$1,164)
7	(\$1,168)	\$0	(\$1,168)
8	(\$1,067)	\$0	(\$1,067)
9	(\$1,092)	\$0	(\$1,092)
10	(\$1,059)	\$0	(\$1,059)
11	(\$1,181)	\$0	(\$1,181)
12	(\$1,314)	\$0	(\$1,314)
13	(\$1,117)	\$0	(\$1,117)
14	(\$1,190)	\$0	(\$1,190)
15	(\$750)	\$0	(\$750)
16	(\$1,512)	(\$3)	(\$1,514)
Total	(\$1,208)	(\$0.01)	(\$1,208)

Table 250: Average 2026 PV 30-year LSC Savings – New Construction and Additions –Central HPWH – HPWH_SPwMPTM – All Prototypes

Climate Zone	30-Year LSC Electricity Savings (2026 PV\$)	30-Year LSC Natural Gas Savings (2026 PV\$)	Total 30-Year LSC Savings (2026 PV\$)
1	\$1,913	(\$2)	\$1,912
2	\$1,752	\$0	\$1,752
3	\$1,690	\$0	\$1,690
4	\$1,522	\$0	\$1,522
5	\$1,689	\$0	\$1,689
6	\$1,402	\$0	\$1,402
7	\$1,399	\$0	\$1,399
8	\$1,282	\$0	\$1,282
9	\$1,299	\$0	\$1,299
10	\$1,253	\$0	\$1,253
11	\$1,307	\$0	\$1,307
12	\$1,477	\$0	\$1,477
13	\$1,230	\$0	\$1,230
14	\$1,368	\$0	\$1,368
15	\$817	\$0	\$817
16	\$2,810	(\$6)	\$2,804
Total	\$1,414	(\$0.02)	\$1,414

7.4.3 First Cost

Incremental first cost is the initial cost to adopt more efficient equipment or building practice when compared to the cost of an equivalent baseline project. Therefore, it was important that the Statewide CASE Team consider first costs in evaluating overall measure Cost-Effectiveness. Incremental first costs are based on data available today and can change over time as markets evolve and professionals become familiar with new technology and building practices.

For both the base case and proposed systems defined in Table 207, the Statewide CASE Team gathered costs for the entire central HPWH systems. The difference between the baseline and proposed systems costs is the incremental costs.

The Statewide CASE Team developed a BOD for each prototype described in Section 7.3.1.2 and worked with two mechanical contractors to get cost estimates. The mechanical contractors provided material and labor cost estimates for the entire central HPWH systems, disaggregated by the central HPWH equipment itself; DHW plant piping; commissioning and startup; general conditions and overhead; design and engineering; and a contractor profit or market factor. Incremental costs for each prototype include material and installation cost for the following items:

Equipment, including heaters, tanks, pumps, heat exchangers, mixing valves, etc.

- Material, including piping, insulation.
- Plumbing, including pumps, valves, and fittings.
- Commissioning and start-up
- Markups for overhead and profit

For structural, electrical and controls costs, the Statewide CASE Team assumes that they are same for base case and proposed cases.

When calculating the installed cost for all the base design and proposed designs, the Statewide CASE Team averaged the total equipment cost and the total material cost between the two contractors. The installed costs for the baseline and proposed designs are presented in Table 251 through Table 254. The details about the incremental cost breakdown can be found in Appendix H.

Table 251: Installed Cost for Baseline and Proposed Central HPWH Designs for LowRiseGarden

Cost	HPWH Base	HPWH_SPST	HPWH_SPRetP	HPWH_MPRetP
Equipment Total	\$58,089	\$35,221	\$57,024	\$98,535
Labor Total	\$8,365	\$8,365	\$8,335	\$10,533
Total	\$66,454	\$43,586	\$65,359	\$109,068
Total Per Dwelling Unit Cost	\$8,307	\$5,448	\$8,170	\$13,633
Incremental Cost per Dwelling Unit	NA	-\$2,858	-\$137	\$5,327

Table 252: Installed Cost for Baseline and Proposed Central HPWH Designs for LoadedCorridor

Cost	HPWH Base	HPWH_SPST	HPWH_SPRetP	HPWH_MPRetP
Equipment Total	\$148,654	\$82,352	\$105,894	\$273,205
Labor Total	\$13,113	\$16,713	\$8,985	\$18,405
Total	\$161,766	\$99,065	\$114,879	\$291,610
Total Per Dwelling Unit Cost	\$4,494	\$2,752	\$3,191	\$8,100
Incremental Cost per Dwelling Unit	NA	-\$1,742	-\$1,302	\$3,607

Table 253: Installed Cost for Baseline and Proposed Central HPWH Designs for MidRiseMixedUse

Cost	HPWH Base	HPWH_SPST	HPWH_SPRetP	HPWH_MPRetP	HPWH_SPwMPTM
Equipment Total	\$362,880	\$139,985	\$206,682	\$316,960	\$362,880
Labor Total	\$31,783	\$21,493	\$16,138	\$19,628	\$31,783
Total	\$394,663	\$161,477	\$222,820	\$336,588	\$394,663
Total Per Dwelling Unit Cost	\$4,485	\$1,835	\$2,532	\$3,825	\$4,485
Incremental Cost per Dwelling Unit	NA	-\$2,650	-\$1,953	-\$660	NA

Table 254: Installed Cost for Baseline and Proposed Central HPWH Designs for HighRiseMixedUse

Cost	HPWH Base	HPWH_SPST	HPWH_SPRetP	HPWH_MPRetP	HPWH_SPwMPTM
Equipment total	\$422,589	\$160,707	\$300,631	\$328,040	\$304,901
Labor total	\$36,205	\$24,090	\$20,238	\$24,088	\$28,985
Total	\$458,794	\$184,797	\$320,868	\$352,128	\$333,886
Total Per Dwelling Unit Cost	\$3,921	\$1,579	\$2,742	\$3,010	\$2,854
Incremental Cost per Dwelling Unit	NA	-\$2,342	-\$1,179	-\$912	-\$1,068

7.4.4 Incremental Maintenance and Replacement Costs

Incremental maintenance cost is the incremental cost of replacing the equipment or parts of the equipment, as well as periodic maintenance required to keep the equipment operating relative to current practices over the 30-year period of analysis. The present value of equipment maintenance costs (or savings) was calculated using a three percent discount rate (d), which is consistent with the discount rate used when developing the 2025 Lifecycle Cost Hourly Factors. The present value of maintenance costs that occurs in the nth year is calculated as follows:

$$Present\ Value\ of\ Maintenance\ Cost = Maintenance\ Cost \times \left[\frac{1}{1 + d} \right]^n$$

The Statewide CASE Team assumed that the expected useful life of the DHW measures is 15 years, and that after this time, the DHW equipment would have to be replaced. The Statewide CASE Team assumed that the supporting infrastructure would not need to be replaced.

The Statewide CASE Team assumed that maintenance costs are the same between system types, and therefore, did not account for any incremental maintenance costs.

The Statewide CASE Team assumed that the primary HPWH equipment needs to be replaced every 15 years. The Statewide CASE Team also averaged the replacement cost across the two contractors. Table 255 through Table 258 summarizes the replacement and maintenance cost during the 30-year period of analysis.

Table 255: Replacement and Maintenance Nominal Cost for Baseline and Proposed Single-Pass Central DWH Designs for LowRiseGarden

Incremental Cost	Year	HPWH_ SPST - Baseline	HPWH_ SPST - Proposed	HPWH_ SPRetP	HPWH_ MPRetP
Heat Pump Water Heaters	15	\$39,142	\$18,882	\$39,142	\$78,283

Table 256: Replacement and Maintenance Nominal Cost for Baseline and Proposed Single-Pass Central DWH Designs for LoadedCorridor

Incremental Cost	Year	HPWH_ SPST - Baseline	HPWH_ SPST - Proposed	HPWH_ SPRetP	HPWH_ MPRetP
Heat Pump Water Heaters	15	\$117,425	\$52,190	\$80,017	\$234,849

Table 257: Replacement and Maintenance Nominal Cost for Baseline and Proposed Single-Pass Central DWH Designs for MidRiseMixedUse

Incremental Cost	Year	HPWH_ SPST - Baseline	HPWH_ SPST - Proposed	HPWH_ SPRetP	HPWH_ MPRetP	HPWH_ SPwMPT M
Heat Pump Water Heaters	15	\$273,991	\$56,070	\$160,035	\$258,416	\$28,035

Table 258: Replacement and Maintenance Nominal Cost for Baseline and Proposed Single-Pass Central DWH Designs for HighRiseMixedUse

Incremental Cost	Year	HPWH_ SPST - Baseline	HPWH_ SPST - Proposed	HPWH_ SPRetP	HPWH_ MPRetP	HPWH_ SPwMPT M
Water Heaters, Primary Storage Tanks	15	\$313,132	\$56,070	\$240,052	\$258,416	\$56,070

7.4.5 Cost-Effectiveness

This measure does not propose mandatory requirement or a revision to the primary prescriptive requirements. A cost analysis is not necessary because the measure is not proposed to be part of the baseline level of stringency. The Statewide CASE Team has provided information about the Cost-Effectiveness of the measure in Table 259 through Table 262, even though the CEC does not require a cost-effectiveness analysis for the measure to be adopted. Benefits and costs are defined as follows:

- Benefits: 30-year LSC Savings + Other PV Savings:** Benefits include LSC savings over the 30-year period of analysis (California Energy Commission 2022). Other savings are discounted at a real (nominal – inflation) three percent rate. Other PV savings include incremental first-cost savings if proposed first cost is less than current first cost, incremental PV maintenance cost savings if PV of proposed maintenance costs is less than PV of current maintenance costs, and incremental residual value if proposed residual value is greater than current residual value at end of CASE analysis period.
- Costs: Total Incremental Present Valued Costs:** Costs include incremental equipment, replacement, and maintenance costs over the period of analysis if PV of proposed costs is greater than PV of current costs. Costs are discounted at a real (inflation-adjusted) three percent rate. If incremental maintenance cost is negative, it is treated as a positive benefit. If there are no total incremental PV costs, the B/C ratio is infinite.

Table 259: 30-Year Cost-Effectiveness Summary Per Dwelling Unit - New Construction & Additions - HPWH_SPST

Climate Zone	Benefits LSC Savings + Other PV Savings (2026 PV\$)	Costs Total Incremental PV Costs (2026 PV\$)	B/C Ratio
1	\$3,098	-\$4,404	>1
2	\$2,832	-\$4,441	>1
3	\$2,736	-\$4,504	>1
4	\$2,417	-\$4,510	>1
5	\$2,725	-\$4,600	>1
6	\$2,291	-\$4,519	>1
7	\$2,314	-\$4,587	>1
8	\$2,068	-\$4,473	>1
9	\$2,097	-\$4,449	>1
10	\$2,018	-\$4,496	>1
11	\$2,070	-\$4,496	>1
12	\$2,337	-\$4,589	>1
13	\$1,961	-\$4,588	>1
14	\$2,179	-\$4,403	>1
15	\$1,297	-\$4,403	>1
16	\$3,912	-\$4,405	>1
Total	\$2,278	-\$4,502	>1

Table 260: 30-Year Cost-Effectiveness Summary Per Dwelling Unit - New Construction & Additions - HPWH_SPRetP

Climate Zone	Benefits LSC Savings + Other PV Savings (2026 PV\$)	Costs Total Incremental PV Costs (2026 PV\$)	B/C Ratio
1	\$84	-\$2,609	>1
2	\$120	-\$2,676	>1
3	\$138	-\$2,696	>1
4	\$117	-\$2,718	>1
5	\$115	-\$2,770	>1
6	\$160	-\$2,681	>1
7	\$137	-\$2,723	>1
8	\$170	-\$2,651	>1
9	\$172	-\$2,637	>1
10	\$174	-\$2,666	>1
11	\$133	-\$2,669	>1
12	\$133	-\$2,729	>1
13	\$155	-\$2,728	>1
14	\$120	-\$2,607	>1
15	\$232	-\$2,607	>1
16	\$54	-\$2,613	>1
Total	\$151	-\$2,678	>1

Table 261: 30-Year Cost-Effectiveness Summary Per Dwelling Unit - New Construction & Additions - HPWH_MPRetP

Climate Zone	Benefits LSC Savings + Other PV Savings (2026 PV\$)	Costs Total Incremental PV Costs (2026 PV\$)	B/C Ratio
1	-\$1,729	\$2,064	<1
2	-\$1,536	\$2,065	<1
3	-\$1,455	\$2,099	<1
4	-\$1,366	\$2,096	<1
5	-\$1,489	\$2,137	<1
6	-\$1,164	\$2,114	<1
7	-\$1,168	\$2,145	<1
8	-\$1,067	\$2,094	<1
9	-\$1,092	\$2,084	<1
10	-\$1,059	\$2,104	<1
11	-\$1,181	\$2,104	<1
12	-\$1,314	\$2,144	<1
13	-\$1,117	\$2,144	<1
14	-\$1,190	\$2,064	<1
15	-\$750	\$2,064	<1
16	-\$1,514	\$2,063	<1
Total	-\$1,208	\$2,104	<1

Table 262: 30-Year Cost-Effectiveness Summary Per Dwelling Unit - New Construction & Additions - HPWH_SPwMPTM

Climate Zone	Benefits LSC Savings + Other PV Savings (2026 PV\$)	Costs Total Incremental PV Costs (2026 PV\$)	B/C Ratio
1	\$1,912	-\$2,919	>1
2	\$1,752	-\$2,960	>1
3	\$1,690	-\$2,983	>1
4	\$1,522	-\$2,995	>1
5	\$1,689	-\$3,040	>1
6	\$1,402	-\$2,979	>1
7	\$1,399	-\$3,015	>1
8	\$1,282	-\$2,955	>1
9	\$1,299	-\$2,942	>1
10	\$1,253	-\$2,967	>1
11	\$1,307	-\$2,968	>1
12	\$1,477	-\$3,018	>1
13	\$1,230	-\$3,017	>1
14	\$1,368	-\$2,918	>1
15	\$817	-\$2,918	>1
16	\$2,804	-\$2,921	>1
Total	\$1,414	-\$2,974	>1

7.5 Annual Statewide Impacts

The code change proposal would not modify the stringency of the existing California Energy Code, so the savings associated with this proposed change are minimal. Typically, the Statewide CASE Team presents a detailed analysis of statewide energy and cost savings associated with the proposed change in Section 7.5 of the report.

7.5.1 Statewide GHG Emissions Reductions

The proposed code change would not result in GHG Emission savings.

7.5.2 Statewide Water Use Impacts

The proposed code change would not result in water savings.

7.5.3 Statewide Material Impacts

The proposed code change would not result in significant material impacts since it is a clean-up of existing prescriptive requirement.

7.5.4 Other Non-Energy Impacts

The proposed code change would not result in other non-energy impacts.

7.6 Addressing Energy Equity and Environmental Justice

The Statewide CASE Team assessed the potential impacts of the proposed measure on DIPs. See Section 2 for a summary of research methods and potentially impacted populations, as well as other general potential equity impacts (DC Fiscal Policy Institute 2017).

Including impacted communities in the decision-making process, ensuring that the benefits and burdens of the energy sector are evenly distributed, and grappling with the unjust legacies of the past all serve as critical steps to achieving energy equity. Code change proposals must be developed and adopted with intentional screening for unintended consequences, otherwise they risk perpetuating systemic injustices and oppression.

The Statewide CASE Team assessed the potential impacts of the proposed measure on DIPs. While all measures have the potential to impact DIPs, this proposal involves multifamily buildings, giving it the potential to have greater impacts on DIPs, especially low-income households and low-income census tracts. Additionally, this measure specifically addresses issues with HPWH performance. HPWHs are an important technology in multifamily construction for low-income housing. This is because HPWHs reduce utility costs and allow the developer to take advantage of various electrification

incentive programs. In its assessment of this measure's impact on DIPs, the Statewide CASE Team determined that the proposed central HPWH requirements have a positive impact.

7.6.1 Potential Impacts

The proposed measure would result in reduced on-site electricity and energy costs, and possibly result in lower maintenance costs, which would provide a higher benefit to people in low-income households and low-income census tracts who spend a higher percentage of their income than the average household on energy and rent.

7.6.2 Evolution of the Code Change Proposal and Future Opportunities

Central HPWHs are now not required in the building code as prescriptive design and have been shown to be cost effective, but they are currently more expensive than gas DHW systems. While not in the Statewide CASE Team's scope, there is an opportunity to work with industry to reduce the cost of central HPWH systems. This could be accomplished through a combination of initiatives like incentives to increase market adoption, training to help designers and contractors become more familiar and comfortable with the systems, or other policy interventions.

8. Individual HPWH Ventilation

8.1 Measure Description

HPWHs are a compressor-based water heating device that extracts heat from an air source and transfers it into water, generating hot water for domestic use. Having an adequate thermal resource (heat content and temperature of air flowing into the evaporator) is critical for the operation and efficiency of a HPWH. This measure proposes to establish ventilation requirements for consumer integrated HPWHs that would be mandatory for all multifamily and single family buildings.⁸¹ Consumer integrated HPWHs are defined under U.S. DOE CFR 431 as HPWHs with storage volumes of 120 gallons or less with an electrical input of less than 24 amps at less than 250 volts. Unless otherwise noted, the term “HPWH” as used in Section 8 refers only to consumer, integrated HPWHs.

HPWHs are typically installed in garages, basements (uncommon in California), attics, and indoor or outdoor water heater closets. The most problematic installations are small closets, which often constrain the heat flow across the evaporator, significantly degrading the operating performance due to reduced evaporator temperatures. The Statewide CASE Team evaluated manufacturer installation requirements and field and laboratory studies of methods for providing ventilation air to HPWHs, such as locating the unit in large rooms, ducting the evaporator air intake and/or exhaust, louvered doors, and ventilation grilles, as well as the source for the inlet air (indoor vs. outdoor makeup air). Through these evaluations, the Statewide CASE Team found that:

- Efficiency depends heavily on being installed with adequate ventilation air.
- Not all ventilation methods work adequately in all 16 climate zones as variability with inlet air and inlet water temperatures impact HPWH efficiency.
- Most manufacturers provide ventilation requirements and guidance that if followed would ensure adequate performance in most cases.
- Evidence suggests that many HPWHs installed to date in small closets in California likely are not performing as expected, due to inadequate ventilation.

Based on these findings, supported by the analysis detailed in this report, the Statewide CASE Team proposes the code changes described below.

⁸¹ In addition to the least cost-effective scenario for residential, the CEC requested that the Statewide CASE Team examine a few specific nonresidential scenarios where consumer integrated HPWHs could be installed. This nonresidential analysis is included in Appendix H.

8.1.1 Proposed Code Change

This measure would include the following code changes:

- Add and adjust existing definitions in Section 100.1(b) to better differentiate HPWH types, so that the proposed ventilation air requirements do not impact HPWHs that do not need ventilation air.
- Add a “Heat pump water heater” section to the end of Section 110.3(c).
 - Language is based on ventilation air for gas appliances requirements from the California Plumbing and Mechanical codes.
 - Proposed code change provides for four basic HPWH ventilation paths:
 1. Large unvented room/closet.
 - Minimum room volume of 100 ft³ / kBtu/h of compressor input capacity, or manufacturer specified requirements.
 2. Small vented room/closet.
 - Minimum room volume of 20 ft³ / kBtu/h of compressor capacity or manufacturer specified requirements.
 - Larger of 125 in² net free area (NFA) plus 25 in², or manufacturer specified requirements.
 3. Directly ducted to the HPWH inlet or outlet in any size room/closet.
 - With the addition of basic requirements like insulating the exhaust ducting and sealing duct joints with mastic.
 4. Novel ventilation methods approved by the manufacturer and included in permit application for approval from the building department.
 - Proposed code prohibits using outdoor air for ventilation air without backup heat if compressor cutout is above the Winter Median of Extremes in Joint Appendix 2.2, Table 2-3.

These requirements would also be used to support the Individual DHW Electric Ready CASE measure, presented in Section 9.

8.1.2 Justification and Background Information

8.1.2.1 Justification

With federal, state, local, and utility incentive programs, and a cultural drive towards reducing carbon emissions, the market for HPWHs in California has increased significantly over the last few years. Water heating accounts for 40 percent of natural gas consumption in the residential sector, representing 7 percent of the state’s total GHG emissions (E3 2019). Water heating energy use in multifamily buildings can

account for 27 to 32 percent of total energy use based on 2015 Residential Energy Consumption Survey by U.S. EIA. In 2022, Governor Gavin Newsom announced plans to expand California's climate change programs through CARB and the CEC, with goals to install six million heat pumps (including HPWHs) by 2030 (Newsom 2022). This is in addition to other simultaneous efforts at the state and federal level to limit or eliminate the sale of gas-fired water heaters, including:

- CPUC decision to eliminate natural gas line subsidies, effective July 2023 (CPUC 2022).
- CARB adopted plans to ban gas-fired water heaters by 2030 (CARB 2022).
- U.S. DOE released a Technical Support Document showing clear Cost-Effectiveness for HPWHs (U.S. DOE, EERE 2022). Based on this document and an industry proposal (ACEEE, et al. 2022), a notice of proposed rulemaking is expected in 2023 that would increase the stringency of consumer water heater efficiency requirements, supporting transition to HPWHs, especially from electric resistance storage water heaters.

All these regulatory and political factors indicate a significant increase in the rate of adoption for HPWHs in the coming years.

Under 2019 Title 24, Part 6, HPWHs were the low-rise residential (both single family and multifamily buildings three habitable stories or less) DHW baseline when the proposed system is a heat pump or electric resistance system serving individual dwelling units or serving multiple dwelling units with no hot water recirculating loops. Under 2022 Title 24, Part 6, prescriptive requirements for HPWHs were added to Section 170.2. With the prescriptive approach a NEEA Tier-III rated HPWH is required (most HPWHs on the market meet or exceed NEEA Tier-III requirements). Under the performance approach, the federal U.S. DOE minimum efficiencies are used as the standard design baseline.

Several recent field studies and laboratory testing have reported degraded HPWH efficiency when they are installed in confined spaces without adequate ventilation, especially in exterior closets common to many multifamily building applications. The operational efficiency of any HPWH installed in such conditions, including those that are NEEA Tier-III and higher, would be lower than what is assumed in current Title 24 efficiency calculations. This reduction in efficiency is due both to the impact of lower evaporator temperature as well as the increased likelihood of second state electric heating.

This proposal provides for four methods to install HPWHs with adequate ventilation that would better assure the unit would perform as expected and protect the investment for the occupant and building owner. The proposal includes minimum requirements for these ventilation methods.

8.1.2.2 Background Information

HPWHs require a consistent thermal resource with adequate ventilation to function efficiently. Efficient operation is achieved when the HPWH relies primarily on compressor-based heating, rather than electric resistance element(s), which serve as second stage or backup heating. A consistent thermal resource can be provided by installing in a large space by venting to other spaces through grilles and louvered doors or by ducting the HPWHs directly to another space.

Laboratory and field⁸² testing have shown that in cramped closets without adequate ventilation, the operational efficiency of a HPWH would be lower than what is assumed in current Title 24 compliance software calculations. Based on findings from extensive lab testing completed by NEEA, Larson Energy Research, and PG&E Code Readiness (see 0), inadequate HPWH ventilation was found to degrade COP by 18 – 57 percent in small closets and cause excessive electric resistance backup heat use. The Statewide CASE Team proposes to include HPWH ventilation requirements in the 2025 Energy Code that would better assure that the unit would perform at acceptable levels.

8.1.3 Summary of Proposed Changes to Code Documents

The sections below summarize how the Title 24, Part 6 standards, Reference Appendices, ACM Reference Manuals, and compliance forms would be modified by the proposed change.⁸³ See Section 11 of this report for detailed proposed code language revisions.

8.1.3.1 Specific Purpose and Necessity of Proposed Code Changes

Each proposed change to language in Title 24, Part 1 and Part 6 as well as the reference appendices to Part 6 are described below. See Section 11 of this report for marked-up code language.

Section: 100.1(b)

Specific Purpose: The specific purpose of the changes is to update existing definitions and add new definitions that allow the code to differentiate between the different types of HPWHs and between integrated HPWHs and other package heat pump units that provide DHW, as well as to define terms used to describe ventilation methods for HPWHs.

⁸² For example: “Evaluation of Unitary Heat Pump Water Heaters with Load-Shifting Controls in a Shared Multi-Family Configuration.” Hoeschele and Haile. (2022). <https://www.etcc-ca.com/reports/evaluation-unitary-heat-pump-water-heaters-load-shifting-controls-shared-multi-family>

⁸³ Visit [EnergyCodeAce.com](https://www.energycodeace.com) for trainings, tools and resources to help people understand existing code requirements.

Necessity: These changes are necessary to ensure that new code only applies to types of HPWHs that need ventilation and to ensure correct use of ventilation methods to increase energy efficiency via cost-effective building design standards, as directed by California Public Resources Code Sections 25213 and 25402.

Section: 110.3(c)7

Specific Purpose: The specific purpose of this addition is to establish ventilation requirements for consumer HPWHs.

Necessity: This addition is necessary to increase energy efficiency via cost-effective building design standards, as directed by California Public Resources Code Sections 25213 and 25402.

8.1.3.2 Specific Purpose and Necessity of Changes to the Residential and Nonresidential ACM Reference Manuals

The proposed code change would not modify the ACM Reference Manuals. Rather, this code change ensures that HPWH installs in confined spaces meet the performance expectations of the existing ACM.

8.1.3.3 Summary of Changes to the Residential and Nonresidential/Multifamily Compliance Manuals

Chapter 5 of the Residential Compliance Manual and Chapter 4 of the Nonresidential /Multifamily Compliance Manual would need to be revised. These revisions would include an overview of new requirements to provide ventilation air for HPWHs. These chapters should also provide diagrams, additional considerations at each stage of installation for facilitating compliance, and technical examples for how to comply under each of the four ventilation methods outlined in the proposed code change.

8.1.3.4 Summary of Changes to Compliance Forms

The proposed code change would modify the compliance forms listed below. Examples of the revised forms are presented in Section 11.5.

- **2022-LMCC-PLB-01-E:** Adds reference to mandatory ventilation requirement.
- **2022-LMCI-PLB-E:** Adds reference to mandatory ventilation requirement.
- **2022-LMCI-PLB-01-E:** Adds reference to mandatory ventilation requirement.
- **2022-LMCI-PLB-02-E:** Adds reference to mandatory ventilation requirement.
- **2022-LMCI-PLB-21-H:** Adds reference to mandatory ventilation requirement.
- **2022-LMCI-PLB-22-H:** Adds reference to mandatory ventilation requirement.
- **2022-LMCV-PLB-21-H:** Adds reference to mandatory ventilation requirement.
- **2022-LMCV-PLB-22-H:** Adds reference to mandatory ventilation requirement.
- **2022-NRCC-PLB-E:** Adds reference to mandatory ventilation requirement.

- **2022-NRCI-PLB-E:** Adds reference to mandatory ventilation requirement.
- **2022-NRCV-PLB-21-H:** Adds reference to mandatory ventilation requirement.
- **2022-NRCV-PLB-22-H:** Adds reference to mandatory ventilation requirement.
- **2022-CF1R-ADD-01-E:** Adds reference to mandatory ventilation requirement.
- **2022-CF1R-ALT-01-E:** Adds reference to mandatory ventilation requirement.
- **2022-CF1R-NCB-01-E:** Adds reference to mandatory ventilation requirement.
- **2022-CF1R-ADD-02-E:** Adds reference to mandatory ventilation requirement.
- **2022-CF1R-ALT-05-E:** Adds reference to mandatory ventilation requirement.
- **2022-CF2R-ADD-02-E:** Adds reference to mandatory ventilation requirement.
- **2022-CF2R-ALT-05-E:** Adds reference to mandatory ventilation requirement.
- **2022 CF2R-PLB-02-E:** Adds reference to mandatory ventilation requirement.
- **2022 CF2R-PLB-22-H:** Adds reference to mandatory ventilation requirement.
- **2022 CF3R-PLB-22-H:** Adds reference to mandatory ventilation requirement.

8.1.4 Regulatory Context

8.1.4.1 Determination of Inconsistency or Incompatibility with Existing State Laws and Regulations

There are no relevant state or local laws or regulations.

8.1.4.2 Duplication or Conflicts with Federal Laws and Regulations

There are no relevant federal laws or regulations.

8.1.4.3 Difference From Existing Model Codes and Industry Standards

There are no relevant industry standards or model codes.

8.1.5 Compliance and Enforcement

When developing this proposal, the Statewide CASE Team considered methods to streamline the compliance and enforcement process and how negative impacts on market actors who are involved in the process could be mitigated or reduced. This section describes how to comply with the proposed code change. It also describes the compliance verification process. Section 8.2 presents how the proposed changes could impact various market actors.

The compliance verification activities related to this measure that need to occur during each phase of the project are described below:

- **Design Phase:** The designer must consider integrated HPWH ventilation requirements when producing the design. The minimum requirements in the proposal are consistent with what most HPWH manufacturers require; therefore, designers should already be meeting those requirements in their designs.

Designs that fail to meet these requirements would void manufacturer warranties if installed as designed according to interviews with manufacturers. With the adoption of this proposal, designers would be able to reference the code requirements in their designs. While this proposal does not change existing compliance documentation, compliance manuals would include examples for designers to reference. Additionally, designers may use novel ventilation methods if certified by the HPWH manufacturer and approved by the enforcement agency. To use this novel compliance pathway, designers should work with manufacturers and obtain certification from them that the design provides acceptable performance for the specified HPWH model. The designer would include the manufacturer's certification in the permit application to the enforcement agency. If approved by the enforcement agency, the novel ventilation method may be used.

- **Permit Application Phase:** Plan examiners must consider the ventilation requirements when conducting plan check reviews. Plans examiners would verify that the design adheres to one of the compliance paths specified in the proposed code. For example, if ventilation is provided using a louvered door, the examiner would check that the appropriate amount of NFA is specified in the plans for the HPWH specified in the plans. Compliance manuals would include examples for examiners to reference in discussions with applicants. However, the proposed code provides a compliance pathway where designers may use a novel ventilation method in their design if certified by the HPWH manufacturer to be effective with their equipment. Designers must include documentation of that approval with the design submitted to the enforcement agency. If that compliance pathway is used, examiners would need to check that approval was granted by the HPWH manufacturer.
- **Construction Phase:** The contractor must ensure ventilation requirements are met when installing the HPWH. If contractors are not already meeting these requirements, they are voiding the warranties of the HPWHs they are installing. Compliance can generally be achieved by following instructions in manufacturer installation manuals and contractor training offered by manufacturers. Compliance manuals would include examples for contractors to reference, as well as recommendations for installation methods that ease compliance and coordination between trades (e.g., using flex water connections to the HPWH instead of hard pipe, so the unit can easily be reoriented in the closet if ducting is required).
- **Inspection Phase:** The inspector must verify ventilation requirements were met when inspecting the installation. The mandatory requirements in this proposal would be referenced on the forms as described in Section 11.5. It is desirable, to ease compliance, to leave it to the individual building departments to determine

at what stage in construction adherence to these requirements is verified. For some installations, where ducting is used to provide ventilation air for the HPWH, this may be after HVAC installation. For others, using the NFA ventilation approach, verification may not be possible later.

8.2 Market Analysis

8.2.1 Current Market Structure

The Statewide CASE Team performed a market analysis with the goals of identifying current technology availability, current product availability, and market trends. It then considered how the proposed standard may impact the market in general as well as individual market actors. Information was gathered about the incremental cost of complying with the proposed measure. Estimates of market size and measure applicability were identified through research and outreach with stakeholders including utility program staff, CEC staff, and a wide range of industry actors. In addition to conducting personalized outreach, the Statewide CASE Team discussed the current market structure and potential market barriers during a public stakeholder meeting that the Statewide CASE Team held on February 17, 2023, (Statewide CASE Team 2023).

In the current market for consumer integrated HPWHs, there are 103 models certified by the CEC and listed in the MAEDBS, and there are 215 models certified by ENERGY STAR. All these integrated HPWHs use R-134a refrigerant, which has a GWP of 1430 and places the compressor cutout (the temperature below which the compressor stops running and the unit switches to backup heat) at around 40°F evaporator inlet air temperature. This impacts HPWH performance when using outdoor air for ventilation, which the Statewide CASE Team considered in their analysis. All models listed in the MAEDBS and ENERGY STAR, and currently available for sale in California, can be ducted, and all manufacturers have minimum ventilation requirements, which were considered while developing this proposal.

Figure 19 shows example consumer integrated HPWHs from the three manufacturers with the most certified units. These manufacturers (with their subsidiary brand names) make up all but one of the units listed in the MAEDBS, and that one unit is not currently available for sale.



Figure 19: Consumer integrated HPWHs (left to right: Bradford-White, A.O. Smith, and Rheem).

Options from manufacturers for providing adequate ventilation vary slightly by manufacturer, but all provide the same basic ventilation pathways:

- Install in a large space (encompassing 450 to 700 ft³ minimum).
- Install in a smaller space, but ensuring free air exchange using louvered doors, ventilation grilles, and door undercuts to net a large free area (approx. 240 in² minimum).
- Install in any size space, with ducting.

Regardless of the ventilation path used, following these requirements from manufacturers involves more than simply specifying equipment. Designers need to consider the location of the HPWH and provide additional detail in building design about how that ventilation is provided. It is important that this is done in the design, as different contractors (e.g., plumbers and HVAC) may be involved in different components of the installation and at different times. It is not possible to specify the equipment and refer the contractor to the manufacturer's installation manual.

For example, if a HPWH is installed in a small closet, and ventilation is to be provided using a louvered door, the electrician and the plumber perform their parts of the install separately before the door is installed by the fenestration contractor. In this case, none of those involved in setting up the HPWH operationally are involved in making sure it receives adequate ventilation, and the one who effectively is ensuring adequate

ventilation knows nothing about how to commission the system and make sure it performs adequately. Therefore, each need to be able to commission their component of the HPWH installation with a specific and detailed design guiding their work.

The main market actors include equipment manufacturers, architects, building owners/developers, designers, contractors, and energy consultants.

- **Manufacturers:** Equipment manufacturers develop, market, and sell HPWH equipment. They specify minimum ventilation requirements available through installation manuals, contractor training, and other documentation. Manufacturers and their representatives may also provide design, installation, and commissioning assistance for a manufacturer's equipment line, including for ventilation requirements.
- **Architects:** Architects design the buildings and plan for the spaces where HPWH systems are installed. Decisions made by architects on the size and location of mechanical/plumbing areas, as well as other aspects of building layout, not only impact construction cost, but they can significantly impact the performance of integrated HPWHs. For example, insufficient HPWH closet volume would result in increased resistance heat backup operation, lowering the energy savings and Cost-Effectiveness.
- **Building Owners/Developers:** Owners and developers are the ultimate decision makers on the type of systems that go into their buildings. Developers work alongside designers to determine whether HPWHs are an option for their designs and how the units are integrated into the building design.
- **Designers:** Designers are responsible for designing plumbing systems, including those for HPWHs. Once the HPWH option passes through concept design stage, designers work directly with manufacturers to design the system and specify equipment. In addition to technical design aspects, designers must consider a myriad of site and project details. Site-level needs include building electrical upgrades, physical space for hosting the HPWHs, and the method to provide adequate ventilation. Designers are likely more familiar with ventilation requirements for HPWHs than architects and must collaborate with the architect on the ventilation method. Designers must also collaborate with installation contractors to meet permitting and compliance requirements.
- **Contractors:** In new construction, HPWH equipment is usually installed by the plumbing contractor, with coordination by a general contractor. After installation of the HPWH unit, an HVAC contractor may need to install ducting, or a fenestration contractor may need to install the appropriate water heater closet door. Regardless of the ventilation method, the general contractor should recognize that a HPWH install involves multiple trades that need to be

coordinated and that the general contractor themselves may need to conduct final commissioning.

- **Energy consultants:** Energy consultants both complete energy code-compliance modeling and advise design teams on improved design approaches. These professionals would need to learn how the design and modeling of HPWH systems is different from gas systems, so they can appropriately advise design teams and accurately model the systems for code compliance.

8.2.2 Technical Feasibility and Market Availability

The HPWH installation requirements to improve the thermal resource available to the equipment are based on manufacturers' requirements and independent laboratory testing. The proposed code language is generally less stringent than the manufacturers' requirements. According to the manufacturers the Statewide CASE Team spoke with, the consensus was that the proposed code requirements should not supplant manufacturer requirements. Rather, they lead to minimally acceptable installation scenarios while enforcing a product's own install requirements. Consequently, given that the products all have similar existing requirements, the proposal is clearly technically feasible.

The proposed code changes concern installation practices and design strategies. While applicable to HPWHs, they do not make requirements of the HPWH equipment itself. As described in the market structure section, nearly all the actors involved in a HPWH installation would need to be cognizant of the requirements to implement them. As with other design and install practices, accounting for the requirements from the beginning of a new construction project makes them easier to implement, such as installing the correct louvered door.

The specific products, material, trades' experience, and design knowledge for HPWH ventilation requirements are commonly available or directly transferable from similar applications. For example, installing an air transfer grille in the wall to satisfy combustion air requirements is necessary when installing a natural-draft gas water heater. The proposed HPWH ventilation code changes require larger versions of those grilles. Further, acceptable grilles of nearly any size and aspect ratio are commonly available, as the same types of grilles are used for ducted air conditioning systems. Likewise, the process and materials required for installing a duct for venting a HPWH is similar to the process for installing a bath fan or range hood exhaust.

Based on plan review of multifamily buildings and interviews of contractors, the Statewide CASE Team found many HPWH installations to-date failed to meet the manufacturer recommended ventilation requirements, as shown in Figure 20.

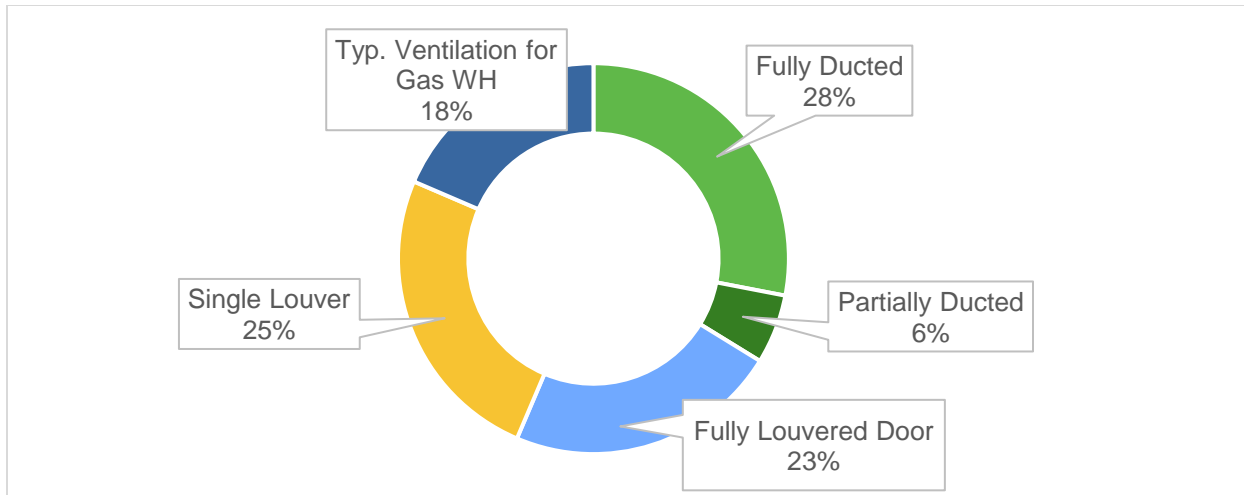

Figure 20: HPWH ventilation methods used in reviewed designs.



Figure 21: Fully louvered door.

Forty-two percent of the HPWH installations in small closets were ducted. Some manufacturers specify the use of “fully louvered doors” on small closets for HPWHs. These are doors with louvers from the top to the bottom of the door, similar to the example shown in Figure 21. Of the unducted units identified in the plan review, only 29 percent used fully louvered doors for ventilation, though none of these appeared from plans to have sufficient NFA. The rest of the plans provided no more ventilation than

would have been required for a gas-fired tank water heater adhering to the California Plumbing Code.⁸⁴

As demonstrated by laboratory test results (see 0

: Individual HPWH Ventilation Detail), inadequate thermal resource can result in a HPWH's installed efficiency (i.e., COP) being cut by half or more. A common method for providing ventilation in small closets is using a fully louvered door with a high enough NFA. The Statewide CASE Team conducted a survey of louvered door manufacturers/suppliers, and the costs of these louvered doors are no different than their non-louvered counterparts. Other low-cost options for providing ventilation also exist, including installing grilles or louvered sections on a solid door or adding a short duct through the closet wall or even through the closet door itself.

In the Statewide CASE Team's review of existing or planned HPWH installations that would fail to meet these code requirements, it found evidence that designers and contractors were not trying to circumvent manufacturer requirements, but rather were unaware of them. For instance, the Statewide CASE Team encountered a building where the plan to provide venting for the water heater was with a 4" PVC pipe. This is standard practice for vented, gas-fired water heater, but ventilation needs for a HPWH are different. Therefore, this code proposal would address the market barrier of education and awareness on HPWH ventilation requirements for proper operation and performance.

8.2.3 Market Impacts and Economic Assessments

8.2.3.1 Impact on Builders

Builders of residential and commercial structures are directly impacted by many of the measures proposed by the Statewide CASE Team for the 2025 code cycle. It is within the normal practices of these businesses to adjust their building practices to changes in building codes. When necessary, builders engage in continuing education and training to remain compliant with changes to design practices and building codes.

California's construction industry comprises approximately 93,000 business establishments and 943,000 employees (see Table 263). For 2022, total estimated payroll would be about \$78 billion. Nearly 72,000 of these business establishments and 473,000 employees are engaged in the residential building sector, while another 17,600 establishments and 369,000 employees focus on the commercial sector. The remainder of establishments and employees work in industrial, utilities, infrastructure, and other heavy construction roles (the industrial sector).

⁸⁴ California Plumbing Code 2022, Chapter 5, Section 506.0

Table 263: California Construction Industry, Establishments, Employment, and Payroll in 2022 (Estimated)

Building Type	Construction Sectors	Establishments	Employment	Annual Payroll (Billions \$)
Residential	All	71,889	472,974	31.2
Residential	Building Construction Contractors	27,948	130,580	9.8
Residential	Foundation, Structure, & Building Exterior	7,891	83,575	5.0
Residential	Building Equipment Contractors	18,108	125,559	8.5
Residential	Building Finishing Contractors	17,942	133,260	8.0
Commercial	All	17,621	368,810	35.0
Commercial	Building Construction Contractors	4,919	83,028	9.0
Commercial	Foundation, Structure, & Building Exterior	2,194	59,110	5.0
Commercial	Building Equipment Contractors	6,039	139,442	13.5
Commercial	Building Finishing Contractors	4,469	87,230	7.4
Industrial, Utilities, Infrastructure, & Other (Industrial+)	All	4,206	101,002	11.4
Industrial+	Building Construction	288	3,995	0.4
Industrial+	Utility System Construction	1,761	50,126	5.5
Industrial+	Land Subdivision	907	6,550	1.0
Industrial+	Highway, Street, and Bridge Construction	799	28,726	3.1
Industrial+	Other Heavy Construction	451	11,605	1.4

Source: (State of California n.d.)

The proposed change to integrated HPWH ventilation would likely affect residential builders but would not impact firms that focus on construction and retrofit of industrial buildings, utility systems, public infrastructure, or other heavy construction. The effects on the residential building industry would not be felt by all firms and workers, but rather would be concentrated in specific industry subsectors. Table 264 shows the residential building subsectors the Statewide CASE Team expects to be impacted by the changes proposed in this report. The additional design and mechanical work required to implement this measure is a departure from current code requirements. The Statewide CASE Team’s estimates of the magnitude of these impacts are shown in Section 8.2.4 Economic Impacts.

Table 264: Specific Subsectors of the California Residential Building Industry by Subsector in 2022 (Estimated)

Residential Building Subsector	Establishments	Employment	Annual Payroll (Billions \$)
New multifamily general contractors	421	6,344	0.7
New housing for-sale builders	189	3,969	0.5
Residential Framing Contractors	741	25,028	1.3
Residential Masonry Contractors	1,177	10,071	0.6
Residential plumbing and HVAC contractors	9,852	75,404	5.1
Residential Drywall Contractors	1,901	32,631	2.0
Residential Painting Contractors	4,869	26,402	1.3

Source: (State of California n.d.)

8.2.3.2 Impact on Building Designers and Energy Consultants

Adjusting design practices to comply with changing building codes is within the normal practices of building designers. Building codes (including Title 24, Part 6) are typically updated on a three-year revision cycle and building designers and energy consultants engage in continuing education and training in order to remain compliant with changes to design practices and building codes.

Businesses that focus on residential, commercial, institutional, and industrial building design are contained within the Architectural Services sector (NAICS 541310). Table 265 shows the number of establishments, employment, and total annual payroll for Building Architectural Services. The proposed code changes would potentially impact all firms within the Architectural Services sector. The Statewide CASE Team anticipates the impacts for integrated HPWH ventilation to affect firms that focus multifamily and nonresidential construction.

There is not a NAICS⁸⁵ code specific to energy consultants. Instead, businesses that focus on consulting related to building energy efficiency are contained in the Building Inspection Services sector (NAICS 541350), which is comprised of firms primarily

⁸⁵ NAICS is the standard used by federal statistical agencies in classifying business establishments for the purpose of collecting, analyzing, and publishing statistical data related to the U.S. business economy. NAICS was developed jointly by the U.S. Economic Classification Policy Committee (ECPC), Statistics Canada, and Mexico's Instituto Nacional de Estadística y Geografía, to allow for a high level of comparability in business statistics among the North American countries. NAICS replaced the Standard Industrial Classification (SIC) system in 1997.

engaged in the physical inspection of residential and nonresidential buildings.⁸⁶ It is not possible to determine which business establishments within the Building Inspection Services sector are focused on energy efficiency consulting. The information shown in Table 265 provides an upper bound indication of the size of this sector in California.

Table 265: California Building Designer and Energy Consultant Sectors in 2022 (Estimated)

Sector	Establishments	Employment	Annual Payroll (Millions \$)
Architectural Services^a	4,134	31,478	3,623.3
Building Inspection Services^b	1,035	3,567	280.7

Source: (State of California n.d.)

- a. Architectural Services (NAICS 541310) comprises private-sector establishments primarily engaged in planning and designing residential, institutional, leisure, commercial, and industrial buildings and structures.
- b. Building Inspection Services (NAICS 541350) comprises private-sector establishments primarily engaged in providing building (residential & nonresidential) inspection services encompassing all aspects of the building structure and component systems, including energy efficiency inspection services.

8.2.3.3 Impact on Occupational Safety and Health

The proposed code change does not alter any existing federal, state, or local regulations pertaining to safety and health, including rules enforced by the California DOSH. All existing health and safety rules would remain in place. Complying with the proposed code change is not anticipated to have adverse impacts on the safety or health of occupants or those involved with the construction, commissioning, and maintenance of the building.

8.2.3.4 Impact on Building Owners and Occupants Including Homeowners and Potential First-Time Homeowners

Residential Buildings

According to data from the U.S. Census ACS, there were more than 14.5 million housing units in California in 2021 and nearly 13.3 million were occupied (see Table 266). Most housing units (nearly 9.42 million) were single family homes (either detached or attached), approximately 2 million homes were in buildings containing two to nine

⁸⁶ Establishments in this sector include businesses primarily engaged in evaluating a building's structure and component systems and includes energy efficiency inspection services and home inspection services. This sector does not include establishments primarily engaged in providing inspections for pests, hazardous wastes or other environmental contaminants, nor does it include state and local government entities that focus on building or energy code compliance/enforcement of building codes and regulations.

units, and 2.5 million homes were in multifamily buildings containing 10 or more units. The California Department of Revenue estimated that building permits for 67,300 single family and 54,900 multifamily homes were to be issued in 2022, up from 66,000 single family and 53,500 multifamily permits issued in 2021.

Table 266: California Housing Characteristics in 2021^a

Housing Measure	Estimate
Total housing units	14,512,281
Occupied housing units	13,291,541
Vacant housing units	1,220,740
Homeowner vacancy rate	0.7%
Rental vacancy rate	4.3%
Number of 1-unit, detached structures	8,388,099
Number of 1-unit, attached structures	1,030,372
Number of 2-unit structures	348,295
Number of 3- or 4-unit structures	783,663
Number of 5- to 9-unit structures	856,225
Number of 10- to 19-unit structures	740,126
Number of 20+ unit structures	1,828,547
Mobile home, RV, etc.	522,442

Sources: (United States Census Bureau n.d.), (Federal Reserve Economic Data (FRED) n.d.)

a. Total housing units as reported for 2021; all other housing measures estimated based on historical relationships.

Table 267 shows the distribution of California homes by vintage. About 15 percent of California homes were built in 2000 or later and another 11 percent built between 1990 and 1999. The majority of California’s existing housing stock (8.5 million homes – 59 percent of the total) were built between 1950 and 1989, a period of rapid population and economic growth in California. Finally, about 2.1 million homes in California were built before 1950. According to Kenney et al, 2019, more than half of California’s existing multifamily buildings (those with five or more units) were constructed before 1978 when there was no Title 24, Part 6 California Energy Code (Kenney 2019).

Table 267: Distribution of California Housing by Vintage in 2021 (Estimated)

Home Vintage	Units	Percent	Cumulative Percent
Built 2014 or later	348,296	2.4	2.4
Built 2010 to 2013	261,221	1.8	4.2
Built 2000 to 2009	1,581,839	10.9	15.1
Built 1990 to 1999	1,596,351	11.0	26.1
Built 1980 to 1989	2,191,354	15.1	41.2
Built 1970 to 1979	2,539,649	17.5	58.7
Built 1960 to 1969	1,915,621	13.2	71.9
Built 1950 to 1959	1,930,133	13.3	85.2
Built 1940 to 1949	841,712	5.8	91.0
Built 1939 or earlier	1,306,105	9.0	100.0
Total housing units	14,512,281	100.0	—

Sources: (United States Census Bureau n.d.)

Table 268 shows the distribution of owner- and renter-occupied housing by household income. Overall, about 55 percent of California housing is owner-occupied and the rate of owner-occupancy generally increases with household income. The owner-occupancy rate for households with an income below \$50,000 is only 37 percent, whereas the owner occupancy rate is 71 percent for households earning \$100,000 or more.

Table 268: Owner- and Renter-Occupied Housing Units in California by Income in 2021 (Estimated)

Household Income	Total	Owner Occupied	Renter Occupied
Less than \$5,000	353,493	113,315	240,178
\$5,000 to \$9,999	254,304	74,939	179,366
\$10,000 to \$14,999	495,287	134,633	360,654
\$15,000 to \$19,999	412,498	144,064	268,435
\$20,000 to \$24,999	467,694	169,431	298,264
\$25,000 to \$34,999	906,996	355,968	551,028
\$35,000 to \$49,999	1,319,892	560,453	759,438
\$50,000 to \$74,999	2,036,560	990,769	1,045,791
\$75,000 to \$99,999	1,662,032	920,607	741,425
\$100,000 to \$149,999	2,307,889	1,490,247	817,642
\$150,000 or more	3,074,895	2,337,651	737,244
Total Housing Units	13,291,541	7,292,076	5,999,465

Source: (United States Census Bureau n.d.)

Understanding the distribution of California residents by home type, home vintage, and household income is critical for developing meaningful estimates of the economic impacts associated with proposed code changes affecting residents. Many proposed code changes specifically target single family or multifamily residences and so the counts of housing units by building type shown in Table 266 provides the information necessary to quantify the magnitude of potential impacts. Likewise, impacts may differ for owners and renters, by home vintage, and by household income, information provided in Table 267 and Table 268.

Estimating Impacts

For California residents, the proposed code changes would result in lower energy bills. The Statewide CASE Team estimates that on average the proposed change to Title 24, Part 6 would increase construction cost by about \$178 per multifamily dwelling unit and single family home, but the measure would also result in a savings of \$5,135 in energy and maintenance cost savings over 30 years. This is roughly equivalent to a \$1.07 month increase in payments for a 30-year mortgage and a \$14.26 per month reduction in energy costs. Overall, the Statewide CASE Team expects the 2025 Title 24, Part 6 Standards to save homeowners about \$158 per year relative to homeowners whose dwelling units and single family homes are minimally compliant with the 2022 Title 24, Part 6 requirements. As discussed in Section 8.2.4, when homeowners or building occupants save on energy bills, they tend to spend it elsewhere thereby creating jobs and economic growth for the California economy. Energy cost savings can be particularly beneficial to low-income homeowners who typically spend a higher portion of their income on energy bills, often have trouble paying energy bills, and sometimes go without other necessities to save money for energy bills (Association, National Energy Assistance Directors 2011).

8.2.3.5 Impact on Building Component Retailers (Including Manufacturers and Distributors)

The Statewide CASE Team anticipates the proposed change would have no material impact on California component retailers. There may be an increase in the sale of ventilation products (ductwork and components, grilles, etc.), but this is difficult to quantify and likely not significant compared to existing sales of such products. Louvered doors have costs similar to standard doors and are available from most door manufacturers and retailers.

8.2.3.6 Impact on Building Inspectors

Table 269 shows employment and payroll information for state and local government agencies in which many inspectors of residential and commercial buildings are employed. Building inspectors participate in continuing education and training to stay current on all aspects of building regulations, including energy efficiency. Therefore, the Statewide

CASE Team, anticipates the proposed change would have no impact on employment of building inspectors or the scope of their role conducting energy efficiency inspections.

Table 269: Employment in California State and Government Agencies with Building Inspectors in 2022 (Estimated)

Sector	Govt.	Establishments	Employment	Annual Payroll (Million \$)
Administration of Housing Programs ^a	State	18	265	29.0
	Local	38	3,060	248.6
Urban and Rural Development Admin ^b	State	38	764	71.3
	Local	52	2,481	211.5

Source: (State of California, Employment Development Department n.d.)

- a. Administration of Housing Programs (NAICS 925110) comprises government establishments primarily engaged in the administration and planning of housing programs, including building codes and standards, housing authorities, and housing programs, planning, and development.
- b. Urban and Rural Development Administration (NAICS 925120) comprises government establishments primarily engaged in the administration and planning of the development of urban and rural areas. Included in this industry are government zoning boards and commissions.

8.2.3.7 Impact on Statewide Employment

As described in Sections 8.2.3.1 through 8.2.3.6, the Statewide CASE Team does not anticipate significant employment or financial impacts to any particular sector of the California economy. This is not to say that the proposed change would not have modest impacts on employment in California. In Section 8.2.4, the Statewide CASE Team estimated the proposed change in integrated HWPV ventilation would affect statewide employment and economic output directly and indirectly through its impact on builders, designers and energy consultants, and building inspectors. In addition, the Statewide CASE Team estimated how energy savings associated with the proposed change in integrated HWPV ventilation would lead to modest ongoing financial savings for California residents, which would then be available for other economic activities.

8.2.4 Economic Impacts

For the 2025 code cycle, the Statewide CASE Team used the IMPLAN model software⁸⁷, along with economic information from published sources and professional judgement, to develop estimates of the economic impacts associated with each of the proposed code changes. Conceptually, IMPLAN estimates jobs created as a function of incoming cash flow in different sectors of the economy, due to implementing a code or a

⁸⁷ IMPLAN employs economic data and advanced economic impact modeling to estimate economic impacts for interventions like changes to the California Title 24, Part 6 code. For more information on the IMPLAN modeling process, see www.IMPLAN.com.

standard. The jobs created are typically categorized into direct, indirect, and induced employment. For example, cash flow into a manufacturing plant captures direct employment (jobs created in the manufacturing plant), indirect employment (jobs created in the sectors that provide raw materials to the manufacturing plant) and induced employment (jobs created in the larger economy due to purchasing habits of people newly employed in the manufacturing plant). Eventually, IMPLAN computes the total number of jobs created due to a code. The assumptions of IMPLAN include constant returns to scale, fixed input structure, industry homogeneity, no supply constraints, fixed technology, and constant byproduct coefficients. The model is also static in nature and is a simplification of how jobs are created in the macro-economy.

The economic impacts developed for this report are only estimates and are based on limited and to some extent speculative information. The IMPLAN model provides a relatively simple representation of the California economy and, though the Statewide CASE Team is confident that the direction and approximate magnitude of the estimated economic impacts are reasonable, it is important to understand that the IMPLAN model is a simplification of extremely complex actions and interactions of individual, businesses, and other organizations as they respond to changes in energy efficiency codes. In all aspect of this economic analysis, the Statewide CASE Team relies on conservative assumptions regarding the likely economic benefits associated with the proposed code change. By following this approach, the economic impacts presented below represent lower bound estimates of the actual benefits associated with this proposed code change.

Adoption of this code change proposal would result in relatively modest economic impacts through the additional direct spending of those in the residential building and remodeling industry, as well as indirectly as residents spend all or some of the money saved through lower utility bills on other economic activities.⁸⁸ There may also be some nonresidential customers that are impacted by this proposed code change; however, the Statewide CASE Team does not anticipate such impacts to be materially important to the building owner and would have measurable economic impacts.

⁸⁸ For example, for the lowest income group, the Statewide CASE Team assumes 100 percent of money saved through lower energy bills would be spent, while for the highest income group, the Statewide CASE Team assumes only 64 percent of additional income would be spent.

Table 270: Estimated Impact that Adoption of the Proposed Measure would have on the California Residential Construction Sector

Type of Economic Impact	Employment (Jobs)	Labor Income	Total Value Added	Output
Direct Effects (Additional spending by Residential Builders)	0.9	\$74,867	\$99,037	\$120,779
Indirect Effect (Additional spending by firms supporting Residential Builders)	0.1	\$8,543	\$13,914	\$23,995
Induced Effect (Spending by employees of firms experiencing “direct” or “indirect” effects)	0.4	\$23,970	\$42,915	\$68,305
Total Economic Impacts	1.4	\$107,380	\$155,866	\$213,079

Source: Statewide CASE Team analysis of data from the IMPLAN modeling software.⁸⁹

Table 271: Estimated Impact that Adoption of the Proposed Measure would have on the California Residential Remodel Sector

Type of Economic Impact	Employment (Jobs)	Labor Income	Total Value Added	Output
Direct Effects (Additional spending by Residential Builders)	124.5	\$9,368,873	\$14,259,140	\$30,592,701
Indirect Effect (Additional spending by firms supporting Residential Builders)	76.2	\$5,614,718	\$9,594,059	\$16,299,259
Induced Effect (Spending by employees of firms experiencing “direct” or “indirect” effects)	63.3	\$4,310,305	\$7,717,783	\$12,283,858
Total Economic Impacts	264.0	\$19,293,896	\$31,570,983	\$59,175,819

Source: Statewide CASE Team analysis of data from the IMPLAN modeling software.⁹⁰

8.2.4.1 Creation or Elimination of Jobs

The Statewide CASE Team does not anticipate that the measures proposed for the 2025 code cycle regulation would lead to the creation of new *types* of jobs or the elimination of *existing* types of jobs. In other words, the Statewide CASE Team’s proposed change would not result in economic disruption to any sector of the California economy. Rather, the estimates of economic impacts discussed in Section 8.2.4 would lead to modest changes in employment of existing jobs.

⁸⁹ IMPLAN® model, 2020 Data, IMPLAN Group LLC, IMPLAN System (data and software), 16905 Northcross Dr., Suite 120, Huntersville, NC 28078 www.IMPLAN.com

⁹⁰ IMPLAN® model, 2020 Data, IMPLAN Group LLC, IMPLAN System (data and software), 16905 Northcross Dr., Suite 120, Huntersville, NC 28078 www.IMPLAN.com

8.2.4.2 Creation or Elimination of Businesses in California

As stated in Section 8.2.4, the Statewide CASE Team’s proposed change would not result in economic disruption to any sector of the California economy. The proposed change represents a modest change to building and mechanical design which would not excessively burden or competitively disadvantage California businesses—nor would it necessarily lead to a competitive advantage for California businesses. Therefore, the Statewide CASE Team does not foresee any new businesses being created, nor does the Statewide CASE Team think any existing businesses would be eliminated due to the proposed code changes.

8.2.4.3 Competitive Advantages or Disadvantages for Businesses in California

The proposed code changes would apply to all businesses incorporated in California, regardless of whether the business is located inside or outside of the state.⁹¹ Therefore, the Statewide CASE Team does not anticipate that these measures proposed for the 2025 code cycle regulation would have an adverse effect on the competitiveness of California businesses. Likewise, the Statewide CASE Team does not anticipate businesses located outside of California would be advantaged or disadvantaged.

8.2.4.4 Increase or Decrease of Investments in the State of California

The Statewide CASE Team analyzed national data on corporate profits and capital investment by businesses that expand a firm’s capital stock (referred to as net private domestic investment, or NPDI).⁹² As Table 272 shows, between 2017 and 2021, NPDI as a percentage of corporate profits ranged from a low of 18 in 2020 due to the worldwide economic slowdowns associated with the COVID 19 pandemic to a high of 35 percent in 2019, with an average of 26 percent. While only an approximation of the proportion of business income used for net capital investment, the Statewide CASE Team believes it provides a reasonable estimate of the proportion of proprietor income that would be reinvested by business owners into expanding their capital stock.

⁹¹ Gov. Code, §§ 11346.3(c)(1)(C), 11346.3(a)(2); 1 CCR § 2003(a)(3) Competitive advantages or disadvantages for California businesses currently doing business in the state.

⁹² Net private domestic investment is the total amount of investment in capital by the business sector that is used to expand the capital stock, rather than maintain or replace due to depreciation. Corporate profit is the money left after a corporation pays its expenses.

Table 272: Net Domestic Private Investment and Corporate Profits, U.S.

Year	Net Domestic Private Investment by Businesses, Billions of Dollars	Corporate Profits After Taxes, Billions of Dollars	Ratio of Net Private Investment to Corporate Profits (Percent)
2017	518.473	1882.460	28
2018	636.846	1977.478	32
2019	690.865	1952.432	35
2020	343.620	1908.433	18
2021	506.331	2619.977	19
5-Year Average	-	-	26

Source: (Federal Reserve Economic Data (FRED) n.d.)

The Statewide CASE Team does not anticipate that the economic impacts associated with the proposed measure would lead to significant change (increase or decrease) in investment, directly or indirectly, in any affected sectors of California’s economy. Nevertheless, the Statewide CASE Team can derive a reasonable estimate of the change in investment by California businesses based on the estimated change in economic activity associated with the proposed measure and its expected effect on proprietor income, which the Statewide CASE Team uses a conservative estimate of corporate profits, a portion of which the Statewide CASE Team assumes would be allocated to net business investment.⁹³

8.2.4.5 Incentives for Innovation in Products, Materials, or Processes

The proposed measure would encourage manufacturers to develop innovative ventilation approach to ensure HPWH performance.

8.2.4.6 Effects on the State General Fund, State Special Funds, and Local Governments

The Statewide CASE Team does not expect the proposed code changes would have a measurable impact on the California’s General Fund, any state special funds, or local government funds.

Cost of Enforcement

Cost to the State: State government already has budget for code development, education, and compliance enforcement. While state government would be allocating resources to update the Title 24, Part 6 Standards, including updating education and compliance materials and responding to questions about the revised requirements,

⁹³ 26 percent of proprietor income was assumed to be allocated to net business investment; see Table 272.

these activities are already covered by existing state budgets. The costs to state government are small when compared to the overall costs savings and policy benefits associated with the code change proposals.

Cost to Local Governments: All proposed code changes to Title 24, Part 6 would result in changes to compliance determinations. Local governments would need to train building department staff on the revised Title 24, Part 6 Standards. While this re-training is an expense to local governments, it is not a new cost associated with the 2025 code change cycle. The building code is updated on a triennial basis, and local governments plan and budget for retraining every time the code is updated. There are numerous resources available to local governments to support compliance training that can help mitigate the cost of retraining, including tools, training and resources provided by the IOU Codes and Standards program (such as Energy Code Ace). As noted in Section 8.1.5 and Appendix E, the Statewide CASE Team considered how the proposed code change might impact various market actors involved in the compliance and enforcement process and aimed to minimize negative impacts on local governments.

8.2.4.7 Impacts on Specific Persons

While the objective of any of the Statewide CASE Team’s proposal is to promote energy efficiency, the Statewide CASE Team recognizes that there is the potential that a proposed code change may result in unintended consequences. Refer to Section 8.6 for more details addressing energy equity and environmental justice.

8.2.5 Fiscal Impacts

8.2.5.1 Mandates on Local Agencies or School Districts

There are no relevant mandates to school districts, because this only impacts multifamily and single family buildings. There are also no mandates for local agencies because the requirements would be specified at the Statewide level through Title 24, Part 6.

8.2.5.2 Costs to Local Agencies or School Districts

There are no costs to school districts, because this only impacts multifamily and single family buildings. For local agencies, the Statewide CASE Team does not anticipate any increase in work for building inspectors.

8.2.5.3 Costs or Savings to Any State Agency

There are no costs or savings to state agencies because they would not be involved in enforcement of the measure.

8.2.5.4 Other Non-Discretionary Cost or Savings Imposed on Local Agencies

There are no added non-discretionary costs or savings to local agencies.

8.2.5.5 Costs or Savings in Federal Funding to the State

There are no costs or savings to federal funding to the state. The proposal does not intersect with any federal or state laws or programs that would impact federal funding to the state.

8.3 Energy Savings

The Statewide CASE Team gathered stakeholder input to inform the energy savings analysis. This included input from HPWH manufacturers, energy consultants, researchers, and others. HPWH manufacturers were supportive of this code change proposal in conversations with the Statewide CASE Team. The HPWH ventilation requirements in this proposal effectively require meeting manufacturer requirements for ventilation, which manufacturers have placed in their installation manuals to ensure adequate performance. Energy consultants and researchers also identified projects they were involved with, and they provided data demonstrating savings when HPWHs were retrofitted with adequate ventilation. See Appendix F for a summary of stakeholder engagement.

Energy savings benefits may have potential to disproportionately impact DIPs. Refer to Section 8.6 for more details addressing energy equity and environmental justice.

8.3.1 Energy Savings Methodology

8.3.1.1 Key Assumptions for Energy Savings Analysis

The Statewide CASE Team simulated the energy impacts in every climate zone and applied the climate-zone specific LSC hourly factors when calculating energy and energy cost impacts.

Typical industry practice for HPWH ventilation was used to represent the standard design, which was assumed, for both new construction and alterations, to be the typical ventilation provided to 36 kBtu/h gas storage water heater. 36 kBtu/h is the most common gas-fired storage water heater size for residential. The California Plumbing Code provides for multiple different methods of providing combustion air for gas-fired appliances. A 36 kBtu/h water heater in a small exterior closet would mostly likely be vented with a single opening in the closet enclosure to outdoor air with an NFA of 12 sq.in. and located 12 inches from the top of the enclosure.

Best practice for HPWH ventilation was used to represent the proposed design, which was assumed to be a small closet with 150 sq. in. NFA located 12 inches from the top of the enclosure and 150 sq. in. NFA located 12 inches from the bottom of the enclosure.

8.3.1.2 Energy Savings Methodology per Prototypical Building

The Statewide CASE Team measured per-unit energy savings expected from the proposed code changes in several ways to quantify key impacts. First, savings are calculated by fuel type. Electricity savings are measured in terms of both energy usage and peak demand reduction. Natural gas savings are quantified in terms of energy usage. Second, the Statewide CASE Team calculated source energy savings. Source energy represents the total amount of raw fuel required to operate a building. In addition to all energy used from on-site production, source energy incorporates all transmission, delivery, and production losses. The hourly source energy values provided by the CEC are strongly correlated with GHG emissions. Finally, the Statewide CASE Team calculated LSC savings, formerly known as TDV energy cost savings. LSC Savings are calculated using hourly energy cost metrics for both electricity and natural gas provided by the CEC. These LSC hourly factors are projected over the 30-year life of the building and incorporate the hourly cost of marginal generation, transmission and distribution, fuel, capacity, losses, and cap-and-trade-based CO2 emissions. The CEC directed the Statewide CASE Team to model the energy impacts using specific prototypical building models that represent typical building geometries for different types of buildings (California Energy Commission 2022). The prototype building that the Statewide CASE Team used in the analysis is presented in Table 273.

Table 273: Prototype Buildings Used for Energy, Demand, Cost, and Environmental Impacts Analysis

Prototype Name	Number of Stories	Floor Area (Square Feet)	Description
LowRiseGarden	2	7,680	2-story, 8-unit apartment building. Average dwelling unit size: 960 ft ²
LoadedCorridor	3	40,000	3-story, 36-unit apartment building. Average dwelling unit size: 960 ft ² .
MidRiseMixedUse	5	113,100	4-story (4-story residential, 1-story commercial), 88-unit building. Avg dwelling unit size: 870 ft ² .
HighRiseMixedUse	10	125,400	10-story (9-story residential, 1-story commercial), 117-unit building. Avg dwelling unit size: 850 ft ² .
SF500	1	500	1-story, 1-bedroom detached small home, 9-ft ceilings
SF2100	1	2100	1-story, 3-bedroom house with attached garage, 9-ft ceilings, vented attic and steep-sloped roof
SF2700	2	2700	2-story, 4-bedroom house with attached garage, 9-ft ceilings, 1-ft between floors, vented attic and steep-sloped roof

The Statewide CASE Team estimated LSC, Source Energy, electricity, natural gas, peak demand, and GHG impacts by simulating the proposed code change in EnergyPlus using prototypical buildings and rulesets from the 2025 Research Version of the CBECC software (California Energy Commission n.d.).

CBECC generates two models based on user inputs: the Standard Design and the Proposed Design.⁹⁴ The Standard Design represents the geometry of the prototypical building and a design that uses a set of features that result in a LSC budget and Source Energy budget that is minimally compliant with 2022 Title 24, Part 6 code requirements. Features used in the Standard Design are described in the 2022 Residential ACM Reference Manual. The Proposed Design represents the same geometry as the Standard Design, but it assumes the energy features that the software user describes with user inputs.

Typically, to develop savings estimates for the proposed code changes, the Statewide CASE Team would create Standard Design and Proposed Design models for each prototype building with the Standard Design representing compliance with typical industry practice and the Proposed Design representing compliance with the proposed requirements. Comparing the energy impacts of the Standard Design to the Proposed Design would reveal the impacts of the proposed code change relative to a building that follows industry typical practices.

However, the HPWH model used by CBECC assumes that the HPWH has ideal ventilation and does not have the ability to model less than ideal ventilation cases.⁹⁵ Therefore, while the Proposed Design output by CBECC can be used to represent compliance with the proposed requirements, CBECC cannot model typical industry practice. To address this modeling limitation, the Statewide CASE Team used laboratory test results to adjust ideal ventilation results from CBECC to represent less than ideal scenarios.

From laboratory test data provided by Larson Energy Research, the Statewide CASE Team developed an ambient air temperature bin model of HPWH compressor efficiency using the ventilation levels in the Standard Design and Proposed Design. The Statewide CASE Team also collected hourly energy use and thermal contribution data for each

⁹⁴ CBECC-Res creates a third model, the Reference Design, that represents a building similar to the Proposed Design, but with construction and equipment parameters that are minimally compliant with the 2006 IECC. The Statewide CASE Team did not use the Reference Design for energy impacts evaluations.

⁹⁵ The HPWH model in CBECC assumes that the evaporator inlet temperature is the same as the ambient temperature. Laboratory testing has shown that this is not the case in small closets. Any enclosing of the HPWH, even with a high NFA door, causes some of the exhaust air to be recirculated to the inlet. Additionally, tank losses can warm the closet above ambient temperature while the HPWH is off.

HPWH component from CBECC by probing the intermediary calculations performed by CSE (the simulation engine used by CBECC).

This was done for both interior and exterior closet HPWH locations (in all sixteen climate zones using the SF2100 single family prototype with one through five bedrooms. A single family model was used for expediency. While multifamily considerations like building geometries and apartment unit density influence central HPWH performance, they do not affect integrated HPWHs. For integrated HPWHs, the inputs to and results from the HPWH model in CBECC are the same for both multifamily and single family (for units with the same number of bedrooms). The changes made to the defaults of the SF2100 prototype are shown in Table 274.

Table 274: Modifications Made to the Prototype to Simulate the Least Cost-Effective Scenario (All Climate Zones)

Prototype ID	Objects Modified	Parameter Name	Original Prototype Parameter Value	Least Cost-Effective Design Parameter Value
SF2100 (Interior Closet Prototype)	Proj	SFamCompactDistrib	“not compact”	“Expanded Credit (HERS req’d)”
		SfamUserCompactFactor	NA	0.6
	DHWHeater	HPWHBrand	“(generic)”	“A. O. Smith”
		HPWHModel	“UEF 2 (50 gallon)”	“HPTU 50 120 (50 gallon)”
		TankOutside	0	0
		TankZone	“Garage”	“Conditioned”
		ASHPTSrcOutside	1	0
AmbientCond	“Unconditioned”	“Conditioned”		
SF2100 (Exterior Closet Prototype)	Proj	SfamCompactDistrib	“not compact”	“Expanded Credit (HERS req’d)”
		SfamUserCompactFactor	NA	0.6
	DHWHeater	HPWHBrand	“(generic)”	“A. O. Smith”
		HPWHModel	“UEF 2 (50 gallon)”	“HPTU 50 120 (50 gallon)”
		TankOutside	0	1
		TankZone	“Garage”	NA
		ASHPTSrcOutside	1	1
AmbientCond	“Unconditioned”	“Unconditioned”		

This hourly CBECC data was used with the temperature bin model to adjust the hourly HPWH compressor energy use. Then the electric resistance backup heat energy use was increased or decreased based on the adjusted thermal output of the compressor. In

total, 160 hourly CBECC outputs were processed through the temperature bin model to produce hourly energy use results for 320 cases (16 climate zones, 1 through 5 bedrooms, interior and exterior closets, Standard and Proposed Designs). These hourly results were then used to represent a HPWH in each dwelling unit (according to number of bedrooms) in each of the prototypes listed in Table 273. The “per dwelling unit” HPWH energy use was summed for all units in each prototype, to calculate the total hourly HPWH energy use for the building.

Then the Statewide CASE Team applied the 2025 LSC hourly factors to calculate LSC in 2026 Present Value dollars (2026 PV\$), source energy factors to calculate source energy use in British thermal units per year (kBtu/yr), and hourly GHG emissions factors to calculate annual GHG emissions in (metric tons of carbon dioxide emissions equivalent per year (MT or “tonnes” CO₂e/yr). The Statewide CASE Team also calculated annual peak electricity demand in kilowatts (kW).⁹⁶

All of this was done for each prototype, in each climate zone, for both interior and exterior closets, and for both the Standard and Proposed Designs, for a total of 448 “CBECC-equivalent” results files. These were compared to calculate per-unit energy impacts of the proposed code change.

The Statewide CASE Team simulated the energy impacts in every climate zone and applied the climate-zone specific LSC hourly factors when calculating energy and energy cost impacts.

Per-unit energy impacts for this measure are presented in savings per residential unit, which includes both single family and multifamily.

8.3.1.3 Statewide Energy Savings Methodology

The per-unit energy impacts were extrapolated to statewide impacts using the Statewide Construction Forecasts that the CEC provided. The Statewide Construction Forecasts estimate new construction/additions that would occur in 2026, the first year that the 2025 Title 24, Part 6 requirements are in effect. They also estimate the amount of total existing building stock in 2026, which the Statewide CASE Team used to approximate savings from building alterations. The construction forecast provides

⁹⁶ Normally CBECC would be used for these calculations. CBECC-Res calculates whole-building energy consumption in kilowatt-hours per year (kWh/yr) and therms per year (therms/yr) for every hour of the year measured. It then applies the 2025 LSC hourly factors to calculate LSC in 2026 Present Value dollars (2026 PV\$), source energy factors to calculate source energy use in kilo British thermal units per year (kBtu/yr), and hourly GHG emissions factors to calculate annual GHG emissions in (metric tons of carbon dioxide emissions equivalent per year (MT or “tonnes” CO₂e/yr). CBECC-Res also calculates annual peak electricity demand measured in kilowatts (kW). However, as previously noted, CBECC cannot model less than ideal ventilation, so the Statewide CASE Team had to produce hourly energy consumption results and then apply these calculations independently of CBECC, though the calculations and results are the same as if CBECC had performed them.

construction (new construction/additions and existing building stock) by building type and climate zone, as shown in Appendix A.

Appendix A presents additional information about the methodology and assumptions used to calculate statewide energy impacts.

8.3.2 Per-Unit Energy Impacts Results

Energy savings and peak demand reductions per unit are presented in Table 275 through Table 284. These savings are the same for both new construction/additions and alterations. Results are presented for both HPWHs in exterior closets and HPWHs in interior closets. The per-unit energy savings figures do not account for naturally occurring market adoption or compliance rates. Per-unit annual savings are expected to range from 431 to 1357 kWh/yr for HPWHs in exterior closets and 490 to 1172 kWh/yr for HPWHs in interior closets, depending upon building type and climate zone. Demand reductions are expected to range between 24 kW and 99 kW for HPWHs in exterior closets and 34 to 88 kW for HPWHs in interior closets, depending on building type and climate zone.

This measure reduces HPWH energy consumption by 49 percent on average. Lowest savings are exterior closets in Climate Zone 16 (avg. 29 percent). This is because even with perfect ventilation, there is little that can be done to improve the efficiency of a HPWH in an exterior closet in a cold climate, other than to bring it into conditioned space. Savings from this measure in Climate Zone 16 for interior closets averages 51 percent.

Table 275: Annual Electricity Savings (kWh) Per Residential Unit by Climate Zone (CZ) – Individual HPWH Ventilation – Exterior Closets

Prototype	CZ 1	CZ 2	CZ 3	CZ 4	CZ 5	CZ 6	CZ 7	CZ 8	CZ 9	CZ 10	CZ 11	CZ 12	CZ 13	CZ 14	CZ 15	CZ 16
HighRiseMixedUse	1,017	815	919	775	885	737	744	675	684	651	634	721	613	615	445	650
LoadedCorridor	1,054	845	955	806	921	767	773	703	714	681	657	746	636	642	465	674
LowRiseGarden	1,036	830	933	787	899	747	754	683	693	661	641	731	622	623	450	662
MidRiseMixedUse	1,038	833	940	792	905	754	760	691	701	668	647	735	626	630	457	664
SF500	953	768	870	734	836	703	711	648	653	617	607	684	583	587	431	611
SF2100	1,226	985	1,130	953	1,092	913	917	841	858	823	771	863	747	772	562	784
SF2700	1,357	1,096	1,247	1,056	1,198	1,001	1,017	921	943	908	872	976	842	848	616	855

Table 276: Annual Peak Demand Reduction (kW) Per Residential Unit by Climate Zone (CZ) – Individual HPWH Ventilation – Exterior Closets

Prototype	CZ 1	CZ 2	CZ 3	CZ 4	CZ 5	CZ 6	CZ 7	CZ 8	CZ 9	CZ 10	CZ 11	CZ 12	CZ 13	CZ 14	CZ 15	CZ 16
HighRiseMixedUse	57	57	60	60	62	66	65	63	58	58	43	48	45	40	47	30
LoadedCorridor	63	63	67	64	66	71	69	66	63	60	44	52	46	40	51	32
LowRiseGarden	62	61	64	63	64	69	67	65	61	60	45	51	47	42	49	32
MidRiseMixedUse	61	61	64	63	64	69	67	64	61	59	43	50	46	40	49	31
SF500	40	45	47	50	53	56	57	53	47	51	36	40	38	33	40	24
SF2100	93	86	99	84	88	91	91	79	84	70	48	66	47	38	69	43
SF2700	83	67	83	76	80	85	86	78	70	59	57	66	59	34	65	49

Table 277: Annual Natural Gas Savings (kBtu) Per Residential Unit by Climate Zone (CZ) – Individual HPWH Ventilation – Exterior Closets

Prototype	CZ 1	CZ 2	CZ 3	CZ 4	CZ 5	CZ 6	CZ 7	CZ 8	CZ 9	CZ 10	CZ 11	CZ 12	CZ 13	CZ 14	CZ 15	CZ 16
HighRiseMixedUse	-	-	-	-	-	-	-	-	-	-	-	-	-	-	-	-
LoadedCorridor	-	-	-	-	-	-	-	-	-	-	-	-	-	-	-	-
LowRiseGarden	-	-	-	-	-	-	-	-	-	-	-	-	-	-	-	-
MidRiseMixedUse	-	-	-	-	-	-	-	-	-	-	-	-	-	-	-	-
SF500	-	-	-	-	-	-	-	-	-	-	-	-	-	-	-	-
SF2100	-	-	-	-	-	-	-	-	-	-	-	-	-	-	-	-
SF2700	-	-	-	-	-	-	-	-	-	-	-	-	-	-	-	-

Table 278: Annual Source Energy Savings (kBtu) Per Residential Unit by Climate Zone (CZ) – Individual HPWH Ventilation – Exterior Closets

Prototype	CZ 1	CZ 2	CZ 3	CZ 4	CZ 5	CZ 6	CZ 7	CZ 8	CZ 9	CZ 10	CZ 11	CZ 12	CZ 13	CZ 14	CZ 15	CZ 16
HighRiseMixedUse	1,364	1,212	1,397	1,219	1,335	1,224	1,228	1,115	1,102	1,049	957	1,108	969	918	838	819
LoadedCorridor	1,431	1,267	1,464	1,277	1,404	1,281	1,278	1,169	1,160	1,107	998	1,157	1,013	962	877	846
LowRiseGarden	886	1,236	1,422	1,239	1,360	1,241	1,240	1,127	1,115	1,066	969	1,127	986	933	843	834
MidRiseMixedUse	1,402	1,243	1,435	1,252	1,374	1,256	1,255	1,145	1,134	1,082	980	1,136	994	943	860	835
SF500	1,247	1,132	1,315	1,155	1,252	1,169	1,187	1,078	1,058	994	917	1,044	913	869	823	770
SF2100	1,744	1,525	1,781	1,553	1,730	1,553	1,535	1,431	1,444	1,382	1,195	1,387	1,222	1,172	1,068	968
SF2700	1,785	1,590	1,863	1,636	1,786	1,616	1,635	1,520	1,522	1,449	1,269	1,484	1,360	1,257	1,112	1,002

Table 279: 30-Year LSC Savings Cost Savings (2026 PV\$) Per Residential Unit by Climate Zone (CZ) – Individual HPWH Ventilation – Exterior Closets

Prototype	CZ 1	CZ 2	CZ 3	CZ 4	CZ 5	CZ 6	CZ 7	CZ 8	CZ 9	CZ 10	CZ 11	CZ 12	CZ 13	CZ 14	CZ 15	CZ 16
HighRiseMixedUse	6,499	5,405	6,042	5,082	5,841	4,903	4,922	4,483	4,469	4,260	4,059	4,679	3,965	3,931	2,978	4,038
LoadedCorridor	6,743	5,592	6,304	5,292	6,086	5,124	5,141	4,671	4,680	4,459	4,210	4,847	4,109	4,095	3,114	4,194
LowRiseGarden	6,645	5,505	6,163	5,174	5,954	4,990	5,032	4,561	4,549	4,335	4,123	4,771	4,038	3,991	3,010	4,121
MidRiseMixedUse	6,640	5,513	6,192	5,202	5,982	5,029	5,046	4,590	4,589	4,373	4,145	4,776	4,048	4,024	3,054	4,128
SF500	6,010	5,078	5,638	4,775	5,463	4,614	4,554	4,225	4,208	4,012	3,848	4,372	3,720	3,729	2,874	3,763
SF2100	7,885	6,460	7,535	6,283	7,237	6,169	6,191	5,562	5,681	5,402	4,919	5,624	4,779	4,875	3,774	4,919
SF2700	8,790	7,275	8,144	6,996	7,852	6,609	6,621	6,093	6,164	5,877	5,561	6,300	5,456	5,354	4,078	5,308

Table 280: Annual Electricity Savings (kWh) Per Residential Unit by Climate Zone (CZ) – Individual HPWH Ventilation – Interior Closets

Prototype	CZ 1	CZ 2	CZ 3	CZ 4	CZ 5	CZ 6	CZ 7	CZ 8	CZ 9	CZ 10	CZ 11	CZ 12	CZ 13	CZ 14	CZ 15	CZ 16
HighRiseMixedUse	865	776	776	721	775	690	688	662	670	665	683	721	658	689	513	843
LoadedCorridor	897	806	805	749	805	716	714	687	695	691	710	749	685	717	534	877
LowRiseGarden	878	788	787	732	787	700	698	672	679	675	693	731	667	698	520	856
MidRiseMixedUse	883	793	792	737	792	705	703	676	684	680	699	737	673	705	525	862
SF500	821	738	737	686	737	657	654	630	637	634	652	687	628	657	490	803
SF2100	1,051	946	942	879	943	840	837	808	818	815	841	881	810	848	634	1,034
SF2700	1,172	1,053	1,049	979	1,049	936	932	898	910	904	932	980	896	940	701	1,148

Table 281: Annual Peak Demand Reduction (kW) Per Residential Unit – Individual HPWH Ventilation – Interior Closets

Prototype	CZ 1	CZ 2	CZ 3	CZ 4	CZ 5	CZ 6	CZ 7	CZ 8	CZ 9	CZ 10	CZ 11	CZ 12	CZ 13	CZ 14	CZ 15	CZ 16
HighRiseMixedUse	59	52	50	49	49	48	48	45	48	44	49	50	52	47	46	56
LoadedCorridor	63	56	55	54	54	52	52	49	52	48	51	54	54	50	48	62
LowRiseGarden	61	53	52	52	51	51	51	49	52	47	52	52	53	50	49	58
MidRiseMixedUse	61	54	53	52	52	50	50	47	50	46	50	53	53	49	47	60
SF500	52	46	43	40	42	37	37	34	37	35	39	45	49	40	36	52
SF2100	83	76	76	73	76	73	71	64	66	61	60	72	59	64	53	88
SF2700	79	74	76	77	77	69	69	64	63	64	69	80	69	71	51	87

Table 282: Annual Natural Gas Savings (kBtu) Per Residential Unit by Climate Zone (CZ) – Individual HPWH Ventilation – Interior Closets

Prototype	CZ 1	CZ 2	CZ 3	CZ 4	CZ 5	CZ 6	CZ 7	CZ 8	CZ 9	CZ 10	CZ 11	CZ 12	CZ 13	CZ 14	CZ 15	CZ 16
HighRiseMixedUse	-	-	-	-	-	-	-	-	-	-	-	-	-	-	-	-
LoadedCorridor	-	-	-	-	-	-	-	-	-	-	-	-	-	-	-	-
LowRiseGarden	-	-	-	-	-	-	-	-	-	-	-	-	-	-	-	-
MidRiseMixedUse	-	-	-	-	-	-	-	-	-	-	-	-	-	-	-	-
SF500	-	-	-	-	-	-	-	-	-	-	-	-	-	-	-	-
SF2100	-	-	-	-	-	-	-	-	-	-	-	-	-	-	-	-
SF2700	-	-	-	-	-	-	-	-	-	-	-	-	-	-	-	-

Table 283: Annual Source Energy Savings (kBtu) Per Residential Unit by Climate Zone (CZ) – Individual HPWH Ventilation – Interior Closets

Prototype	CZ 1	CZ 2	CZ 3	CZ 4	CZ 5	CZ 6	CZ 7	CZ 8	CZ 9	CZ 10	CZ 11	CZ 12	CZ 13	CZ 14	CZ 15	CZ 16
HighRiseMixedUse	1,277	1,164	1,160	1,086	1,160	1,035	1,034	986	1,002	1,001	1,054	1,089	1,007	1,057	813	1,269
LoadedCorridor	1,341	1,220	1,214	1,135	1,214	1,084	1,081	1,033	1,052	1,050	1,104	1,141	1,057	1,107	845	1,329
LowRiseGarden	1,066	1,184	1,179	1,103	1,179	1,053	1,051	1,003	1,019	1,018	1,068	1,106	1,022	1,072	821	1,290
MidRiseMixedUse	1,313	1,196	1,191	1,114	1,191	1,063	1,060	1,013	1,031	1,029	1,082	1,119	1,035	1,085	831	1,303
SF500	1,206	1,098	1,096	1,026	1,095	976	977	931	946	944	1,007	1,034	957	1,007	787	1,199
SF2100	1,643	1,486	1,474	1,370	1,471	1,314	1,304	1,259	1,292	1,286	1,343	1,389	1,300	1,349	1,001	1,617
SF2700	1,697	1,556	1,556	1,464	1,548	1,392	1,389	1,341	1,352	1,338	1,416	1,463	1,361	1,426	1,084	1,682

Table 284: 30-year LSC Savings Cost Savings (2026 PV\$) Per Residential Unit by Climate Zone (CZ) – Individual HPWH Ventilation – Interior Closets

Prototype	CZ 1	CZ 2	CZ 3	CZ 4	CZ 5	CZ 6	CZ 7	CZ 8	CZ 9	CZ 10	CZ 11	CZ 12	CZ 13	CZ 14	CZ 15	CZ 16
HighRiseMixedUse	5,672	5,127	5,075	4,702	5,096	4,517	4,464	4,315	4,351	4,310	4,453	4,680	4,284	4,448	3,350	5,457
LoadedCorridor	5,884	5,313	5,283	4,892	5,288	4,706	4,662	4,489	4,527	4,489	4,640	4,878	4,460	4,628	3,483	5,704
LowRiseGarden	5,762	5,191	5,174	4,781	5,191	4,607	4,557	4,405	4,434	4,389	4,532	4,766	4,361	4,517	3,403	5,549
MidRiseMixedUse	5,793	5,232	5,194	4,810	5,206	4,626	4,578	4,415	4,452	4,413	4,560	4,793	4,384	4,550	3,426	5,597
SF500	5,371	4,912	4,747	4,437	4,781	4,217	4,157	4,013	4,073	4,047	4,191	4,395	4,025	4,219	,175	5,147
SF2100	6,885	6,203	6,255	5,790	6,183	5,593	5,591	5,299	5,353	5,329	5,523	5,813	5,289	5,485	4,112	6,879
SF2700	7,788	7,002	6,888	6,553	6,848	6,105	6,097	5,862	5,925	5,864	6,085	6,416	5,855	6,053	4,515	7,619

8.4 Cost and Cost-Effectiveness

8.4.1 Energy Cost Savings Methodology

Energy cost savings were calculated by applying the LSC hourly factors to the energy savings estimates that were derived using the methodology described in Section 8.3.1. LSC hourly factors are a normalized metric to calculate energy cost savings that accounts for the variable cost of electricity and natural gas for each hour of the year, along with how costs are expected to change over the period of analysis. The CEC requested LSC savings over the 30-year period of analysis in both 2026 PV\$ and nominal dollars. The cost-effectiveness analysis uses LSC values in 2026 PV\$. Costs and Cost-Effectiveness using and 2026 PV\$ are presented in Section 8.4 of this report. The CEC uses results in nominal dollars to complete the Economic and Fiscal Impacts Statement (From 399) for the entire package of proposed change to Title 24, Part 6. Appendix G presents LSC savings results in nominal dollars.

The proposed code change applies to all occupancies whenever a consumer integrated HPWH is installed, including in additions and alterations. LSC savings are the same for new construction and additions/alterations.

8.4.2 Energy Cost Savings Results

Per-unit energy cost savings for newly constructed buildings, additions, and alterations in terms of LSC savings realized over the 30-year period of analysis are presented as 2026 PV\$ in Table 285 through Table 316. These savings are the same for both new construction/additions and alterations. Results are presented for both HPWHs in exterior closets and HPWHs in interior closets.

The LSC methodology allows peak electricity savings to be valued more than electricity savings during non-peak periods. This measure results in 0.37 MW of first-year peak electricity savings statewide. This is because providing proper ventilation for HPWHs reduces electric resistance backup heat use, with more heat provided using the lower watt-draw compressor.

Any time code changes impact cost, there is potential to disproportionately impact DIPs. Refer to Section 8.6 for more details addressing energy equity and environmental justice.

Table 285: 2026 PV 30-year LSC Savings – Per Dwelling Unit – New Construction and Additions – HighRiseMixedUse – Exterior Closets

Climate Zone	30-Year LSC Electricity Savings (2026 PV\$)	30-Year LSC Natural Gas Savings (2026 PV\$)	Total 30-Year LSC Savings (2026 PV\$)
1	-	-	-
2	-	-	-
3	-	-	-
4	-	-	-
5	-	-	-
6	-	-	-
7	-	-	-
8	-	-	-
9	-	-	-
10	-	-	-
11	-	-	-
12	-	-	-
13	-	-	-
14	-	-	-
15	-	-	-
16	-	-	-

Table 286: 2026 PV 30-year LSC Savings – Per Dwelling Unit – Alterations – HighRiseMixedUse – Exterior Closets

Climate Zone	30-Year LSC Electricity Savings (2026 PV\$)	30-Year LSC Natural Gas Savings (2026 PV\$)	Total 30-Year LSC Savings (2026 PV\$)
1	6,499	-	6,499
2	5,405	-	5,405
3	6,042	-	6,042
4	5,082	-	5,082
5	5,841	-	5,841
6	4,903	-	4,903
7	4,922	-	4,922
8	4,483	-	4,483
9	4,469	-	4,469
10	4,260	-	4,260
11	4,059	-	4,059
12	4,679	-	4,679
13	3,965	-	3,965
14	3,931	-	3,931
15	2,978	-	2,978
16	4,038	-	4,038

Table 287: 2026 PV 30-year LSC Savings – Per Dwelling Unit – New Construction and Additions – LoadedCorridor – Exterior Closets

Climate Zone	30-Year LSC Electricity Savings (2026 PV\$)	30-Year LSC Natural Gas Savings (2026 PV\$)	Total 30-Year LSC Savings (2026 PV\$)
1	6,743	-	6,743
2	5,592	-	5,592
3	6,304	-	6,304
4	5,292	-	5,292
5	6,086	-	6,086
6	5,124	-	5,124
7	5,141	-	5,141
8	4,671	-	4,671
9	4,680	-	4,680
10	4,459	-	4,459
11	4,210	-	4,210
12	4,847	-	4,847
13	4,109	-	4,109
14	4,095	-	4,095
15	3,114	-	3,114
16	4,194	-	4,194

Table 288: 2026 PV 30-year LSC Savings – Per Dwelling Unit – Alterations – LoadedCorridor – Exterior Closets

Climate Zone	30-Year LSC Electricity Savings (2026 PV\$)	30-Year LSC Natural Gas Savings (2026 PV\$)	Total 30-Year LSC Savings (2026 PV\$)
1	6,743	-	6,743
2	5,592	-	5,592
3	6,304	-	6,304
4	5,292	-	5,292
5	6,086	-	6,086
6	5,124	-	5,124
7	5,141	-	5,141
8	4,671	-	4,671
9	4,680	-	4,680
10	4,459	-	4,459
11	4,210	-	4,210
12	4,847	-	4,847
13	4,109	-	4,109
14	4,095	-	4,095
15	3,114	-	3,114
16	4,194	-	4,194

Table 289: 2026 PV 30-year LSC Savings – Per Dwelling Unit – New Construction and Additions – LowRiseGarden – Exterior Closets

Climate Zone	30-Year LSC Electricity Savings (2026 PV\$)	30-Year LSC Natural Gas Savings (2026 PV\$)	Total 30-Year LSC Savings (2026 PV\$)
1	6,645	-	6,645
2	5,505	-	5,505
3	6,163	-	6,163
4	5,174	-	5,174
5	5,954	-	5,954
6	4,990	-	4,990
7	5,032	-	5,032
8	4,561	-	4,561
9	4,549	-	4,549
10	4,335	-	4,335
11	4,123	-	4,123
12	4,771	-	4,771
13	4,038	-	4,038
14	3,991	-	3,991
15	3,010	-	3,010
16	4,121	-	4,121

Table 290: 2026 PV 30-year LSC Savings – Per Dwelling Unit – Alterations – LowRiseGarden – Exterior Closets

Climate Zone	30-Year LSC Electricity Savings (2026 PV\$)	30-Year LSC Natural Gas Savings (2026 PV\$)	Total 30-Year LSC Savings (2026 PV\$)
1	6,645	-	6,645
2	5,505	-	5,505
3	6,163	-	6,163
4	5,174	-	5,174
5	5,954	-	5,954
6	4,990	-	4,990
7	5,032	-	5,032
8	4,561	-	4,561
9	4,549	-	4,549
10	4,335	-	4,335
11	4,123	-	4,123
12	4,771	-	4,771
13	4,038	-	4,038
14	3,991	-	3,991
15	3,010	-	3,010
16	4,121	-	4,121

Table 291: 2026 PV 30-year LSC Savings – Per Dwelling Unit – New Construction and Additions – MidRiseMixedUse – Exterior Closets

Climate Zone	30-Year LSC Electricity Savings (2026 PV\$)	30-Year LSC Natural Gas Savings (2026 PV\$)	Total 30-Year LSC Savings (2026 PV\$)
1	-	-	-
2	-	-	-
3	-	-	-
4	-	-	-
5	-	-	-
6	-	-	-
7	-	-	-
8	-	-	-
9	-	-	-
10	-	-	-
11	-	-	-
12	-	-	-
13	-	-	-
14	-	-	-
15	-	-	-
16	-	-	-

Table 292: 2026 PV 30-year LSC Savings – Per Dwelling Unit – Alterations – MidRiseMixedUse – Exterior Closets

Climate Zone	30-Year LSC Electricity Savings (2026 PV\$)	30-Year LSC Natural Gas Savings (2026 PV\$)	Total 30-Year LSC Savings (2026 PV\$)
1	6,640	-	6,640
2	5,513	-	5,513
3	6,192	-	6,192
4	5,202	-	5,202
5	5,982	-	5,982
6	5,029	-	5,029
7	5,046	-	5,046
8	4,590	-	4,590
9	4,589	-	4,589
10	4,373	-	4,373
11	4,145	-	4,145
12	4,776	-	4,776
13	4,048	-	4,048
14	4,024	-	4,024
15	3,054	-	3,054
16	4,128	-	4,128

Table 293: 2026 PV 30-year LSC Savings – Per Dwelling Unit – New Construction and Additions – SF500 – Exterior Closets

Climate Zone	30-Year LSC Electricity Savings (2026 PV\$)	30-Year LSC Natural Gas Savings (2026 PV\$)	Total 30-Year LSC Savings (2026 PV\$)
1	6,010	-	6,010
2	5,078	-	5,078
3	5,638	-	5,638
4	4,775	-	4,775
5	5,463	-	5,463
6	4,614	-	4,614
7	4,554	-	4,554
8	4,225	-	4,225
9	4,208	-	4,208
10	4,012	-	4,012
11	3,848	-	3,848
12	4,372	-	4,372
13	3,720	-	3,720
14	3,729	-	3,729
15	2,874	-	2,874
16	3,763	-	3,763

Table 294: 2026 PV 30-year LSC Savings – Per Dwelling Unit – Alterations – SF500 – Exterior Closets

Climate Zone	30-Year LSC Electricity Savings (2026 PV\$)	30-Year LSC Natural Gas Savings (2026 PV\$)	Total 30-Year LSC Savings (2026 PV\$)
1	6,010	-	6,010
2	5,078	-	5,078
3	5,638	-	5,638
4	4,775	-	4,775
5	5,463	-	5,463
6	4,614	-	4,614
7	4,554	-	4,554
8	4,225	-	4,225
9	4,208	-	4,208
10	4,012	-	4,012
11	3,848	-	3,848
12	4,372	-	4,372
13	3,720	-	3,720
14	3,729	-	3,729
15	2,874	-	2,874
16	3,763	-	3,763

Table 295: 2026 PV 30-year LSC Savings – Per Dwelling Unit – New Construction and Additions – SF2100 – Exterior Closets

Climate Zone	30-Year LSC Electricity Savings (2026 PV\$)	30-Year LSC Natural Gas Savings (2026 PV\$)	Total 30-Year LSC Savings (2026 PV\$)
1	7,885	-	7,885
2	6,460	-	6,460
3	7,535	-	7,535
4	6,283	-	6,283
5	7,237	-	7,237
6	6,169	-	6,169
7	6,191	-	6,191
8	5,562	-	5,562
9	5,681	-	5,681
10	5,402	-	5,402
11	4,919	-	4,919
12	5,624	-	5,624
13	4,779	-	4,779
14	4,875	-	4,875
15	3,774	-	3,774
16	4,919	-	4,919

Table 296: 2026 PV 30-year LSC Savings – Per Dwelling Unit – Alterations – SF2100 – Exterior Closets

Climate Zone	30-Year LSC Electricity Savings (2026 PV\$)	30-Year LSC Natural Gas Savings (2026 PV\$)	Total 30-Year LSC Savings (2026 PV\$)
1	7,885	-	7,885
2	6,460	-	6,460
3	7,535	-	7,535
4	6,283	-	6,283
5	7,237	-	7,237
6	6,169	-	6,169
7	6,191	-	6,191
8	5,562	-	5,562
9	5,681	-	5,681
10	5,402	-	5,402
11	4,919	-	4,919
12	5,624	-	5,624
13	4,779	-	4,779
14	4,875	-	4,875
15	3,774	-	3,774
16	4,919	-	4,919

Table 297: 2026 PV 30-year LSC Savings – Per Dwelling Unit – New Construction and Additions – SF2700 – Exterior Closets

Climate Zone	30-Year LSC Electricity Savings (2026 PV\$)	30-Year LSC Natural Gas Savings (2026 PV\$)	Total 30-Year LSC Savings (2026 PV\$)
1	8,790	-	8,790
2	7,275	-	7,275
3	8,144	-	8,144
4	6,996	-	6,996
5	7,852	-	7,852
6	6,609	-	6,609
7	6,621	-	6,621
8	6,093	-	6,093
9	6,164	-	6,164
10	5,877	-	5,877
11	5,561	-	5,561
12	6,300	-	6,300
13	5,456	-	5,456
14	5,354	-	5,354
15	4,078	-	4,078
16	5,308	-	5,308

Table 298: 2026 PV 30-year LSC Savings – Per Dwelling Unit – Alterations – SF2700 – Exterior Closets

Climate Zone	30-Year LSC Electricity Savings (2026 PV\$)	30-Year LSC Natural Gas Savings (2026 PV\$)	Total 30-Year LSC Savings (2026 PV\$)
1	8,790	-	8,790
2	7,275	-	7,275
3	8,144	-	8,144
4	6,996	-	6,996
5	7,852	-	7,852
6	6,609	-	6,609
7	6,621	-	6,621
8	6,093	-	6,093
9	6,164	-	6,164
10	5,877	-	5,877
11	5,561	-	5,561
12	6,300	-	6,300
13	5,456	-	5,456
14	5,354	-	5,354
15	4,078	-	4,078
16	5,308	-	5,308

Table 299: Average 2026 PV 30-year LSC Savings – Per Dwelling Unit – New Construction and Additions – All Prototypes – Exterior Closets

Climate Zone	30-Year LSC Electricity Savings (2026 PV\$)	30-Year LSC Natural Gas Savings (2026 PV\$)	Total 30-Year LSC Savings (2026 PV\$)
1	7,942	-	7,942
2	6,381	-	6,381
3	6,772	-	6,772
4	5,936	-	5,936
5	7,129	-	7,129
6	5,709	-	5,709
7	5,503	-	5,503
8	5,080	-	5,080
9	5,072	-	5,072
10	5,262	-	5,262
11	5,103	-	5,103
12	5,699	-	5,699
13	5,028	-	5,028
14	4,863	-	4,863
15	3,851	-	3,851
16	5,043	-	5,043

Table 300: Average 2026 PV 30-year LSC Savings – Per Dwelling Unit – Alterations – All Prototypes – Exterior Closets

Climate Zone	30-Year LSC Electricity Savings (2026 PV\$)	30-Year LSC Natural Gas Savings (2026 PV\$)	Total 30-Year LSC Savings (2026 PV\$)
1	7,095	-	7,095
2	5,735	-	5,735
3	6,279	-	6,279
4	5,342	-	5,342
5	6,340	-	6,340
6	5,149	-	5,149
7	5,119	-	5,119
8	4,663	-	4,663
9	4,651	-	4,651
10	4,621	-	4,621
11	4,593	-	4,593
12	5,102	-	5,102
13	4,588	-	4,588
14	4,304	-	4,304
15	3,511	-	3,511
16	4,705	-	4,705

Table 301: 2026 PV 30-year LSC Savings – Per Dwelling Unit – New Construction and Additions – HighRiseMixedUse – Interior Closets

Climate Zone	30-Year LSC Electricity Savings (2026 PV\$)	30-Year LSC Natural Gas Savings (2026 PV\$)	Total 30-Year LSC Savings (2026 PV\$)
1	5,672	-	5,672
2	5,127	-	5,127
3	5,075	-	5,075
4	4,702	-	4,702
5	5,096	-	5,096
6	4,517	-	4,517
7	4,464	-	4,464
8	4,315	-	4,315
9	4,351	-	4,351
10	4,310	-	4,310
11	4,453	-	4,453
12	4,680	-	4,680
13	4,284	-	4,284
14	4,448	-	4,448
15	3,350	-	3,350
16	5,457	-	5,457

Table 302: 2026 PV 30-year LSC Savings – Per Dwelling Unit – Alterations – HighRiseMixedUse – Interior Closets

Climate Zone	30-Year LSC Electricity Savings (2026 PV\$)	30-Year LSC Natural Gas Savings (2026 PV\$)	Total 30-Year LSC Savings (2026 PV\$)
1	5,672	-	5,672
2	5,127	-	5,127
3	5,075	-	5,075
4	4,702	-	4,702
5	5,096	-	5,096
6	4,517	-	4,517
7	4,464	-	4,464
8	4,315	-	4,315
9	4,351	-	4,351
10	4,310	-	4,310
11	4,453	-	4,453
12	4,680	-	4,680
13	4,284	-	4,284
14	4,448	-	4,448
15	3,350	-	3,350
16	5,457	-	5,457

Table 303: 2026 PV 30-year LSC Savings – Per Dwelling Unit – New Construction and Additions – LoadedCorridor – Interior Closets

Climate Zone	30-Year LSC Electricity Savings (2026 PV\$)	30-Year LSC Natural Gas Savings (2026 PV\$)	Total 30-Year LSC Savings (2026 PV\$)
1	5,884	-	5,884
2	5,313	-	5,313
3	5,283	-	5,283
4	4,892	-	4,892
5	5,288	-	5,288
6	4,706	-	4,706
7	4,662	-	4,662
8	4,489	-	4,489
9	4,527	-	4,527
10	4,489	-	4,489
11	4,640	-	4,640
12	4,878	-	4,878
13	4,460	-	4,460
14	4,628	-	4,628
15	3,483	-	3,483
16	5,704	-	5,704

Table 304: 2026 PV 30-year LSC Savings – Per Dwelling Unit – Alterations – LoadedCorridor – Interior Closets

Climate Zone	30-Year LSC Electricity Savings (2026 PV\$)	30-Year LSC Natural Gas Savings (2026 PV\$)	Total 30-Year LSC Savings (2026 PV\$)
1	5,884	-	5,884
2	5,313	-	5,313
3	5,283	-	5,283
4	4,892	-	4,892
5	5,288	-	5,288
6	4,706	-	4,706
7	4,662	-	4,662
8	4,489	-	4,489
9	4,527	-	4,527
10	4,489	-	4,489
11	4,640	-	4,640
12	4,878	-	4,878
13	4,460	-	4,460
14	4,628	-	4,628
15	3,483	-	3,483
16	5,704	-	5,704

Table 305: 2026 PV 30-year LSC Savings – Per Dwelling Unit – New Construction and Additions – LowRiseGarden – Interior Closets

Climate Zone	30-Year LSC Electricity Savings (2026 PV\$)	30-Year LSC Natural Gas Savings (2026 PV\$)	Total 30-Year LSC Savings (2026 PV\$)
1	5,762	-	5,762
2	5,191	-	5,191
3	5,174	-	5,174
4	4,781	-	4,781
5	5,191	-	5,191
6	4,607	-	4,607
7	4,557	-	4,557
8	4,405	-	4,405
9	4,434	-	4,434
10	4,389	-	4,389
11	4,532	-	4,532
12	4,766	-	4,766
13	4,361	-	4,361
14	4,517	-	4,517
15	3,403	-	3,403
16	5,549	-	5,549

Table 306: 2026 PV 30-year LSC Savings – Per Dwelling Unit – Alterations – LowRiseGarden – Interior Closets

Climate Zone	30-Year LSC Electricity Savings (2026 PV\$)	30-Year LSC Natural Gas Savings (2026 PV\$)	Total 30-Year LSC Savings (2026 PV\$)
1	5,762	-	5,762
2	5,191	-	5,191
3	5,174	-	5,174
4	4,781	-	4,781
5	5,191	-	5,191
6	4,607	-	4,607
7	4,557	-	4,557
8	4,405	-	4,405
9	4,434	-	4,434
10	4,389	-	4,389
11	4,532	-	4,532
12	4,766	-	4,766
13	4,361	-	4,361
14	4,517	-	4,517
15	3,403	-	3,403
16	5,549	-	5,549

Table 307: 2026 PV 30-year LSC Savings – Per Dwelling Unit – New Construction and Additions – MidRiseMixedUse – Interior Closets

Climate Zone	30-Year LSC Electricity Savings (2026 PV\$)	30-Year LSC Natural Gas Savings (2026 PV\$)	Total 30-Year LSC Savings (2026 PV\$)
1	5,793	-	5,793
2	5,232	-	5,232
3	5,194	-	5,194
4	4,810	-	4,810
5	5,206	-	5,206
6	4,626	-	4,626
7	4,578	-	4,578
8	4,415	-	4,415
9	4,452	-	4,452
10	4,413	-	4,413
11	4,560	-	4,560
12	4,793	-	4,793
13	4,384	-	4,384
14	4,550	-	4,550
15	3,426	-	3,426
16	5,597	-	5,597

Table 308: 2026 PV 30-year LSC Savings – Per Dwelling Unit – Alterations – MidRiseMixedUse – Interior Closets

Climate Zone	30-Year LSC Electricity Savings (2026 PV\$)	30-Year LSC Natural Gas Savings (2026 PV\$)	Total 30-Year LSC Savings (2026 PV\$)
1	5,793	-	5,793
2	5,232	-	5,232
3	5,194	-	5,194
4	4,810	-	4,810
5	5,206	-	5,206
6	4,626	-	4,626
7	4,578	-	4,578
8	4,415	-	4,415
9	4,452	-	4,452
10	4,413	-	4,413
11	4,560	-	4,560
12	4,793	-	4,793
13	4,384	-	4,384
14	4,550	-	4,550
15	3,426	-	3,426
16	5,597	-	5,597

Table 309: 2026 PV 30-year LSC Savings – Per Dwelling Unit – New Construction and Additions – SF500 – Interior Closets

Climate Zone	30-Year LSC Electricity Savings (2026 PV\$)	30-Year LSC Natural Gas Savings (2026 PV\$)	Total 30-Year LSC Savings (2026 PV\$)
1	5,371	-	5,371
2	4,912	-	4,912
3	4,747	-	4,747
4	4,437	-	4,437
5	4,781	-	4,781
6	4,217	-	4,217
7	4,157	-	4,157
8	4,013	-	4,013
9	4,073	-	4,073
10	4,047	-	4,047
11	4,191	-	4,191
12	4,395	-	4,395
13	4,025	-	4,025
14	4,219	-	4,219
15	3,175	-	3,175
16	5,147	-	5,147

Table 310: 2026 PV 30-year LSC Savings – Per Dwelling Unit – Alterations – SF500 – Interior Closets

Climate Zone	30-Year LSC Electricity Savings (2026 PV\$)	30-Year LSC Natural Gas Savings (2026 PV\$)	Total 30-Year LSC Savings (2026 PV\$)
1	5,371	-	5,371
2	4,912	-	4,912
3	4,747	-	4,747
4	4,437	-	4,437
5	4,781	-	4,781
6	4,217	-	4,217
7	4,157	-	4,157
8	4,013	-	4,013
9	4,073	-	4,073
10	4,047	-	4,047
11	4,191	-	4,191
12	4,395	-	4,395
13	4,025	-	4,025
14	4,219	-	4,219
15	3,175	-	3,175
16	5,147	-	5,147

Table 311: 2026 PV 30-year LSC Savings – Per Dwelling Unit – New Construction and Additions – SF2100 – Interior Closets

Climate Zone	30-Year LSC Electricity Savings (2026 PV\$)	30-Year LSC Natural Gas Savings (2026 PV\$)	Total 30-Year LSC Savings (2026 PV\$)
1	6,885	-	6,885
2	6,203	-	6,203
3	6,255	-	6,255
4	5,790	-	5,790
5	6,183	-	6,183
6	5,593	-	5,593
7	5,591	-	5,591
8	5,299	-	5,299
9	5,353	-	5,353
10	5,329	-	5,329
11	5,523	-	5,523
12	5,813	-	5,813
13	5,289	-	5,289
14	5,485	-	5,485
15	4,112	-	4,112
16	6,879	-	6,879

Table 312: 2026 PV 30-year LSC Savings – Per Dwelling Unit – Alterations – SF2100 – Interior Closets

Climate Zone	30-Year LSC Electricity Savings (2026 PV\$)	30-Year LSC Natural Gas Savings (2026 PV\$)	Total 30-Year LSC Savings (2026 PV\$)
1	6,885	-	6,885
2	6,203	-	6,203
3	6,255	-	6,255
4	5,790	-	5,790
5	6,183	-	6,183
6	5,593	-	5,593
7	5,591	-	5,591
8	5,299	-	5,299
9	5,353	-	5,353
10	5,329	-	5,329
11	5,523	-	5,523
12	5,813	-	5,813
13	5,289	-	5,289
14	5,485	-	5,485
15	4,112	-	4,112
16	6,879	-	6,879

Table 313: 2026 PV 30-year LSC Savings – Per Dwelling Unit – New Construction and Additions – SF2700 – Interior Closets

Climate Zone	30-Year LSC Electricity Savings (2026 PV\$)	30-Year LSC Natural Gas Savings (2026 PV\$)	Total 30-Year LSC Savings (2026 PV\$)
1	7,788	-	7,788
2	7,002	-	7,002
3	6,888	-	6,888
4	6,553	-	6,553
5	6,848	-	6,848
6	6,105	-	6,105
7	6,097	-	6,097
8	5,862	-	5,862
9	5,925	-	5,925
10	5,864	-	5,864
11	6,085	-	6,085
12	6,416	-	6,416
13	5,855	-	5,855
14	6,053	-	6,053
15	4,515	-	4,515
16	7,619	-	7,619

Table 314: 2026 PV 30-year LSC Savings – Per Dwelling Unit – Alterations – SF2700 – Interior Closets

Climate Zone	30-Year LSC Electricity Savings (2026 PV\$)	30-Year LSC Natural Gas Savings (2026 PV\$)	Total 30-Year LSC Savings (2026 PV\$)
1	7,788	-	7,788
2	7,002	-	7,002
3	6,888	-	6,888
4	6,553	-	6,553
5	6,848	-	6,848
6	6,105	-	6,105
7	6,097	-	6,097
8	5,862	-	5,862
9	5,925	-	5,925
10	5,864	-	5,864
11	6,085	-	6,085
12	6,416	-	6,416
13	5,855	-	5,855
14	6,053	-	6,053
15	4,515	-	4,515
16	7,619	-	7,619

Table 315: Average 2026 PV 30-year LSC Savings – Per Dwelling Unit – New Construction and Additions – All Prototypes – Interior Closets

Climate Zone	30-Year LSC Electricity Savings (2026 PV\$)	30-Year LSC Natural Gas Savings (2026 PV\$)	Total 30-Year LSC Savings (2026 PV\$)
1	6,480	-	6,480
2	5,712	-	5,712
3	5,411	-	5,411
4	5,161	-	5,161
5	5,746	-	5,746
6	4,925	-	4,925
7	4,764	-	4,764
8	4,626	-	4,626
9	4,647	-	4,647
10	4,872	-	4,872
11	5,214	-	5,214
12	5,379	-	5,379
13	5,050	-	5,050
14	5,095	-	5,095
15	3,939	-	3,939
16	6,578	-	6,578

Table 316: Average 2026 PV 30-year LSC Savings – Per Dwelling Unit – Alterations – All Prototypes – Interior Closets

Climate Zone	30-Year LSC Electricity Savings (2026 PV\$)	30-Year LSC Natural Gas Savings (2026 PV\$)	Total 30-Year LSC Savings (2026 PV\$)
1	6,261	-	6,261
2	5,502	-	5,502
3	5,290	-	5,290
4	4,985	-	4,985
5	5,566	-	5,566
6	4,778	-	4,778
7	4,657	-	4,657
8	4,515	-	4,515
9	4,538	-	4,538
10	4,703	-	4,703
11	5,090	-	5,090
12	5,199	-	5,199
13	4,968	-	4,968
14	4,922	-	4,922
15	3,887	-	3,887
16	6,508	-	6,508

8.4.3 Incremental First Cost

As this measure is only concerned with the ventilation being provided to a HPWH, the incremental first costs considered are only those related to the ventilation methods explicitly mentioned in the proposed code change. These methods are installing in:

1. A large unvented space.
2. A small closet space with louvers or grilles to allow air exchange.
3. Any size space with the exhaust ducted out of that space.

Costs for this proposal are difficult to quantify, as this proposal is requiring what contractors are supposed to be doing already. For the purpose of this proposal, the incremental costs are the cost of providing ventilation according to manufacturer requirements instead of doing nothing to provide ventilation.

These costs would be different depending on the installation scenario, whether new construction, additions, or alterations. Costs would likely be lower in new construction multifamily and production single family than in custom single family or additions/alterations, as production builders and contractors of larger projects would likely be able to take advantage of volume purchasing.

There are no incremental costs associated with method 1 listed above.

To determine the incremental first costs of method 2, the Statewide CASE Team conducted a survey of louvers, grilles, and louvered door options. Costs collected from the survey were for orders of a single unit, which does not account for volume purchasing. The Statewide CASE Team used current costs in our analysis, which are still impacted by the pandemic and inflation. As these influences diminish, there should be a cost decrease.

The survey found that most prefabricated fully louvered doors less than 30 inches wide do not have sufficient NFA for adequate HPWH ventilation. However, many models with sufficient NFA do exist on the current market. Costs range significantly from manufacturer to manufacturer, from less than \$200 to more than \$2,000, depending on the manufacturer, style, and materials (i.e., wood for interior, steel for exterior).

The Statewide CASE Team also surveyed retrofit louver sections. These can be added to any existing or new door. Some door vendors provide the option to have retrofit louvered sections added to new doors before they are shipped to the site. Retrofit louvered sections have high free area ratios, 35 to 50 percent (the free area ratio of most fully louvered doors are between 8-12 percent). Retrofit louvered sections surveyed cost \$1.70 per in² of NFA on average (\$510 for 300 in² NFA). Laboratory testing has shown that having one upper louver section and one lower louver section in the closet door performs identically to a fully louvered door with sufficient NFA.

A low-cost option for adding sufficient NFA to a closet door is grilles, which are a common method of providing ventilation for gas-fired water heaters, as shown in Figure 22.



Figure 22: DHW closet door with lower grilles from a small commercial kitchen in Woodland, CA.

Source: James Haile, Frontier Energy



Figure 23: Ventilation grilles on the door of the closet used in laboratory tests.

Source: Ben Larson, Larson Energy Research.

Grilles can be added to existing or new doors and cost \$20 to \$50 each, depending on the size, and have a free area ratio of 70 to 90 percent (Bailes III 2017). Using upper grilles and lower grilles, as shown in Figure 23, would provide sufficient ventilation for a HPWH and cost \$100 or less. Laboratory testing has shown this configuration to perform identically to a fully louvered door with sufficient NFA.

The labor required to install a prefabricated louvered door is no different from the labor required to install any other door, and therefore was not considered an incremental cost. The labor to retrofit an existing door with louvered sections or grilles were estimated to be 0.5 to one hour, based on interviews with contractors. This is consistent with materials and labor times required for the laboratory tests conducted by Larson Energy Research.

According to interviews with manufacturers, incremental costs of materials for ducting a HPWH are \$200 on average, and implementing the method requires one to two hours of labor. This is consistent with costs for ducting kits from HPWH manufacturers seen

online and with materials and labor times required for the laboratory tests conducted by Larson Energy Research.

Table 317 provides a summary of the incremental first costs discussed above for each ventilation method covered by the proposed code change.

Table 317. Summary of Incremental First Costs by Ventilation Method.

Ventilation Method	Sub Method	Materials Cost	Labor Cost
Large Space	NA	\$0	0
Small Vented Space	Louvered Door	\$200 to \$2000	NC: \$0 Add/Alt: \$97.50
	Louver Sections	\$1.70 per sq. in. NFA (\$510 for 300 sq.in. NFA)	\$195
	Grilles	< \$100	\$97.50
Ducted Any Size Space	NA	\$200	\$195

8.4.4 Incremental Maintenance and Replacement Costs

Incremental maintenance cost is the incremental cost of replacing the equipment or parts of the equipment, as well as periodic maintenance required to keep the equipment operating relative to current practices over the 30-year period of analysis.

The Statewide CASE Team found that all equipment components related to the applicable ventilation methods have a usable life expectancy longer than the 30-year analysis period. Therefore, there are no Lifecycle Cost Hourly Factors to consider. See 0for more detail.

8.4.5 Cost-Effectiveness

This measure proposes a mandatory requirement. As such, a cost analysis is required to demonstrate that the measure is cost effective over the 30-year period of analysis.

The CEC establishes the procedures for calculating Cost-Effectiveness. The Statewide CASE Team collaborated with CEC staff to confirm that the methodology in this report is consistent with their guidelines, including which costs were included in the analysis. The incremental first cost and incremental maintenance costs over the 30-year period of analysis were included. The LSC savings from electricity were also included in the evaluation. Design costs were not included nor were the incremental costs of code compliance verification.

As discussed in Section 8.4 above, there are several options for providing ventilation for HPWHs that are very different from a technical and cost standpoint. Costs for the most expensive options, louvered doors and louvered sections, additionally vary substantially depending on the manufacturer and style of the components. For calculating cost-effectiveness, the Statewide CASE Team chose to use the most universally applicable

ventilation method to both new construction and additions/alterations, which also has the lowest incremental cost: grilles. This carries an incremental first cost of \$177.50 for all prototypes and for both new construction/additions and alterations and there are no costs for maintenance or replacement in the 30-year analysis period.

According to the CEC's definitions, a measure is cost-effective if the B/C ratio is greater than 1.0. The B/C ratio is calculated by dividing the cost benefits realized over 30 years by the total incremental costs, which includes maintenance costs for 30 years. The B/C ratio was calculated using 2026 PV costs and cost savings.

Benefit-to-cost ratio for this measure over the entire 30-year analysis period ranges from 16.2 to 49.5, depending on the prototype and climate zone.

Results of the per-unit, cost-effectiveness analyses are presented in Table 318 and Table 319 for exterior closets in new construction/additions and alterations, respectively. The same for interior closets is presented in Table 320 and Table 321. Benefits and costs are defined as follows:

- **Benefits: 30-year LSC Savings + Other PV Savings:** Benefits include LSC savings over the 30-year period of analysis (California Energy Commission 2022). Other savings are discounted at a real (nominal – inflation) three percent rate. Other PV savings include incremental first-cost savings if proposed first cost is less than current first cost, incremental PV maintenance cost savings if PV of proposed maintenance costs is less than PV of current maintenance costs, and incremental residual value if proposed residual value is greater than current residual value at end of CASE analysis period.
- **Costs: Total Incremental Present Valued Costs:** Costs include incremental equipment, replacement, and maintenance costs over the period of analysis if PV of proposed costs is greater than PV of current costs. Costs are discounted at a real (inflation-adjusted) three percent rate. If incremental maintenance cost is negative, it is treated as a positive benefit. If there are no total incremental PV costs, the B/C ratio is infinite.

Table 318: 30-Year Cost-Effectiveness Summary Per Dwelling Unit – New Construction/Additions – Exterior

Climate Zone	Benefits LSC Savings + Other PV Savings (2026 PV\$)	Costs Total Incremental PV Costs (2026 PV\$)	B/C Ratio
1	\$7,942	\$169	46.95
2	\$6,381	\$205	31.12
3	\$6,772	\$191	35.48
4	\$5,936	\$206	28.89
5	\$7,129	\$205	34.81
6	\$5,709	\$172	33.16
7	\$5,503	\$174	31.70
8	\$5,080	\$171	29.78
9	\$5,072	\$170	29.87
10	\$5,262	\$171	30.70
11	\$5,103	\$173	29.44
12	\$5,699	\$178	32.11
13	\$5,028	\$177	28.48
14	\$4,863	\$168	28.91
15	\$3,851	\$168	22.90
16	\$5,043	\$172	29.31

Table 319: 30-Year Cost-Effectiveness Summary Per Dwelling Unit – Alterations – Exterior

Climate Zone	Benefits LSC Savings + Other PV Savings (2026 PV\$)	Costs Total Incremental PV Costs (2026 PV\$)	B/C Ratio
1	\$7,095	\$169	41.95
2	\$5,735	\$205	27.97
3	\$6,279	\$191	32.89
4	\$5,342	\$206	25.99
5	\$6,340	\$205	30.96
6	\$5,149	\$172	29.91
7	\$5,119	\$174	29.49
8	\$4,663	\$171	27.34
9	\$4,651	\$170	27.39
10	\$4,621	\$171	26.96
11	\$4,593	\$173	26.50
12	\$5,102	\$178	28.74
13	\$4,588	\$177	25.99
14	\$4,304	\$168	25.59
15	\$3,511	\$168	20.87
16	\$4,705	\$172	27.34

Table 320: 30-Year Cost-Effectiveness Summary Per Dwelling Unit – New Construction/Additions – Interior

Climate Zone	Benefits LSC Savings + Other PV Savings (2026 PV\$)	Costs Total Incremental PV Costs (2026 PV\$)	B/C Ratio
1	\$6,479.87	\$169.15	38.31
2	\$5,712.06	\$205.05	27.86
3	\$5,411.00	\$190.88	28.35
4	\$5,160.55	\$205.50	25.11
5	\$5,745.67	\$204.80	28.06
6	\$4,925.34	\$172.18	28.61
7	\$4,763.81	\$173.60	27.44
8	\$4,626.05	\$170.58	27.12
9	\$4,646.67	\$169.78	27.37
10	\$4,872.42	\$171.38	28.43
11	\$5,213.58	\$173.33	30.08
12	\$5,379.04	\$177.50	30.30
13	\$5,049.98	\$176.53	28.61
14	\$5,094.83	\$168.18	30.29
15	\$3,938.54	\$168.18	23.42
16	\$6,578.02	\$172.08	38.23

Table 321: 30-Year Cost-Effectiveness Summary Per Dwelling Unit – Alterations – Interior

Climate Zone	Benefits LSC Savings + Other PV Savings (2026 PV\$)	Costs Total Incremental PV Costs (2026 PV\$)	B/C Ratio
1	\$6,261.21	\$169.15	37.02
2	\$5,502.12	\$205.05	26.83
3	\$5,289.56	\$190.88	27.71
4	\$4,984.94	\$205.50	24.26
5	\$5,565.78	\$204.80	27.18
6	\$4,778.22	\$172.18	27.75
7	\$4,657.16	\$173.60	26.83
8	\$4,515.27	\$170.58	26.47
9	\$4,538.18	\$169.78	26.73
10	\$4,702.96	\$171.38	27.44
11	\$5,090.24	\$173.33	29.37
12	\$5,199.31	\$177.50	29.29
13	\$4,968.43	\$176.53	28.15
14	\$4,922.41	\$168.18	29.27
15	\$3,887.24	\$168.18	23.11
16	\$6,507.68	\$172.08	37.82

8.5 Annual Statewide Impacts

8.5.1 Statewide Energy and Energy Cost Savings

The Statewide CASE Team calculated the first-year statewide savings for new construction and additions by multiplying the per-unit savings, which are presented in Section 8.3.2, by assumptions about the percentage of newly constructed buildings that would be impacted by the proposed code. The statewide new construction forecast for 2026 is presented in Appendix A, as are the Statewide CASE Team's assumptions about the percentage of new construction that would be impacted by the proposal (by climate zone and building type).

The first-year energy impacts represent the first-year annual savings from all buildings that were completed in 2026. The 30-year energy cost savings represent the energy cost savings over the entire 30-year analysis period. The statewide savings estimates do not take naturally occurring market adoption or compliance rates into account. The tables below presents the first-year statewide energy and energy cost savings from newly constructed buildings and additions (Table 322) and alterations (Table 323) by climate zone. Table 324 presents first-year statewide savings from new construction, additions, and alterations.

While a statewide analysis is crucial to understanding broader effects of code change proposals, there is potential to disproportionately impact DIPs that needs to be considered. Refer to Section 8.6 for more details addressing energy equity and environmental justice.

Table 322: Statewide Energy and Energy Cost Impacts – New Construction and Additions

Climate Zone	Statewide New Construction & Additions Impacted by Proposed Change in 2026 Dwelling Units	Annual ^a Electricity Savings (GWh)	Annual Peak Electrical Demand Reduction (MW)	Annual Natural Gas Savings (Million Therms)	Annual Source Energy Savings (Million kBtu)	30-Year Present Valued LSC Savings (Million 2026 PV\$)
1	21	0.02	0.00	-	0.03	\$0.15
2	141	0.13	0.01	-	0.19	\$0.84
3	479	0.43	0.03	-	0.65	\$2.82
4	268	0.22	0.02	-	0.34	\$1.46
5	39	0.04	0.00	-	0.06	\$0.24
6	174	0.14	0.01	-	0.22	\$0.91
7	314	0.24	0.02	-	0.37	\$1.58
8	567	0.41	0.03	-	0.65	\$2.71
9	650	0.48	0.04	-	0.74	\$3.12
10	527	0.41	0.03	-	0.63	\$2.65
11	296	0.24	0.02	-	0.36	\$1.53
12	856	0.72	0.05	-	1.11	\$4.71
13	347	0.27	0.02	-	0.43	\$1.75
14	221	0.17	0.01	-	0.26	\$1.11
15	148	0.09	0.01	-	0.15	\$0.58
16	89	0.08	0.01	-	0.11	\$0.53
Total	5,138	4.09	0.30	-	6.31	\$26.68

a. First-year savings from all buildings completed statewide in 2026.

Table 323: Statewide Energy and Energy Cost Impacts – Alterations

Climate Zone	Statewide Alterations Impacted by Proposed Change in 2026 Dwelling Units	Annual ^a Electricity Savings (GWh)	Annual Peak Electrical Demand Reduction (MW)	Annual Natural Gas Savings (Million Therms)	Annual Source Energy Savings (Million kBtu)	30-Year Present Valued LSC Savings (Million 2026 PV\$)
1	4	0.00	0.00	-	0.00	\$0.02
2	30	0.03	0.00	-	0.04	\$0.17
3	139	0.12	0.01	-	0.18	\$0.79
4	67	0.05	0.00	-	0.08	\$0.34
5	7	0.01	0.00	-	0.01	\$0.04
6	44	0.03	0.00	-	0.05	\$0.21
7	93	0.07	0.01	-	0.11	\$0.45
8	158	0.11	0.01	-	0.17	\$0.72
9	187	0.13	0.01	-	0.20	\$0.86
10	101	0.07	0.01	-	0.11	\$0.47
11	41	0.03	0.00	-	0.05	\$0.20
12	145	0.12	0.01	-	0.18	\$0.75
13	43	0.03	0.00	-	0.05	\$0.21
14	38	0.03	0.00	-	0.04	\$0.18
15	18	0.01	0.00	-	0.02	\$0.07
16	10	0.01	0.00	-	0.01	\$0.06
Total	1,123	0.85	0.06	-	1.30	\$5.54

a. First-year savings from all buildings completed statewide in 2026.

Table 324: Statewide Energy and Energy Cost Impacts – New Construction, Additions, and Alterations

Construction Type	Annual Electricity Savings (GWh)	Annual Peak Electrical Demand Reduction (MW)	First -Year Natural Gas Savings (Million Therms)	Annual Source Energy Savings (Million kBtu)	30-Year Present Valued LSC Savings (PV\$ Million)
New Construction & Additions	4.09	0.30	-	6.31	\$26.68
Alterations	0.85	0.06	-	1.30	\$5.54
Total	4.93	0.37	-	7.61	\$32.22

a. First-year savings from all alterations completed statewide in 2026.

8.5.2 Statewide GHG Emissions Reductions

The Statewide CASE Team calculated avoided GHG emissions associated with energy consumption using the hourly GHG emissions factors that the CEC developed along with the 2025 LLSC hourly factors and an assumed cost of \$123.15 per metric tons of carbon dioxide equivalent emissions (metric tons CO₂e).

The monetary value of avoided GHG emissions is based on a proxy for permit costs (not social costs).⁹⁷ The cost-effectiveness analysis presented in Section 8.4 of this report does not include the cost savings from avoided GHG emissions. To demonstrate the cost savings of avoided GHG emissions, the Statewide CASE Team disaggregated the value of avoided GHG emissions from the other economic impacts.

Table 325 presents the estimated first-year avoided GHG emissions of the proposed code change. During the first year, GHG emissions of 285,921 (metric tons CO₂e) would be avoided.

Table 325: Annual Statewide GHG Emissions Impacts

Measure	Electricity Savings ^a (GWh/yr)	Reduced GHG Emissions from Electricity Savings ^a (Metric Tons CO ₂ e)	Natural Gas Savings ^a (Million Therms/yr)	Reduced GHG Emissions from Natural Gas Savings ^a (Metric Tons CO ₂ e)	Total Reduced GHG Emissions ^b (Metric Ton CO ₂ e)	Total Monetary Value of Reduced GHG Emissions ^c (\$)
Exterior Closet	1.93	157.44	-	-	157.44	\$19,388.34
Interior Closet	3.00	233.85	-	-	233.85	\$28,798.09
TOTAL	4.93	391.29	-	-	391.29	\$48,186.43

- First-year savings from all applicable newly constructed buildings, additions, and alterations completed statewide in 2026.
- GHG emissions were calculated using hourly GHG emissions factors published alongside LSC hourly factors published by CEC here: <https://www.energy.ca.gov/files/2025-energy-code-hourly-factors>
- The monetary value of avoided GHG emissions is based on a proxy for permit costs (not special costs) derived from the 2022 TDV Update model published by the CEC here: <https://www.energy.ca.gov/files/tdv-2022-update-model>

⁹⁷ The permit cost of carbon is equivalent to the market value of a unit of GHG emissions in the California Cap-and-Trade program, while social cost of carbon is an estimate of the total economic value of damage done per unit of GHG emissions. Social costs tend to be greater than permit costs. See more on the Cap-and-Trade Program on the California Air Resources Board website: <https://ww2.arb.ca.gov/our-work/programs/cap-and-trade-program>.

8.5.3 Statewide Water Use Impacts

The proposed code change would not result in water savings.

For more details involving water use and water impacts quality, refer to Appendix B.

8.5.4 Statewide Material Impacts

The code proposal requires ventilation for HPWHs, where there previously would have been no existing ventilation. As discussed in Section 8.2 above, there are several options for providing ventilation for HPWHs that are very different from a technical and cost standpoint. Costs for the most expensive options, louvered doors and louvered sections, additionally vary substantially depending on the manufacturer and style of the components. For calculating cost-effectiveness, the Statewide CASE Team chose to use the most universally applicable ventilation method to both new construction and additions/alterations, which also has the lowest incremental cost: grilles. The Statewide CASE Team has taken the same approach for the purpose of estimating statewide material impacts.

The Statewide CASE Team researched the material composition of grilles using manufacturer specification sheets and estimated the material impacts on a per-unit basis and annually statewide. Grilles are manufactured of either steel or aluminum, with steel being the most common and cheapest composition. However, aluminum is typically used for grilles with additional features, such as closable louvers or a filter insert. This measure specifically calls for fixed louver grilles, and nearly all of those would be manufactured from steel. For estimating the statewide impacts on material use, the Statewide CASE Team assumed that 100 percent of grilles installed would be made of steel. See Appendix D for more details.

Table 326: Annual Statewide Impacts on Material Use – Individual HPWH Ventilation

Material	Impact	Per-Unit Impacts (Pounds)	Annual ^a Statewide Impacts (Pounds)
Steel	Increase	4.22	43,363
TOTAL	-	4.22	43,363

a. First-year savings from all buildings completed statewide in 2026.

8.5.5 Other Non-Energy Impacts

No non-energy impacts were identified.

8.6 Addressing Energy Equity and Environmental Justice

The Statewide CASE Team assessed the potential impacts of the proposed measure on DIPs. See Section 2 for a summary of research methods and potentially impacted populations, as well as other general potential equity impacts.

8.6.1 Potential Impacts

This measure would result in a small increase in construction costs and a larger reduction in energy costs. As discussed in Section 8.4, the incremental cost of this measure is estimated to be \$177.50. The lowest benefit to cost ratio across all prototypes and climate zones over the 30-year Cost-Effectiveness analysis period is 16.2. Other potential impacts include improved hot water availability and longer equipment life. According to discussions with HPWH manufacturers, inadequate ventilation results in significant compressor short cycling which leads to early equipment failure. This measure avoids this early replacement by ensuring adequate ventilation. The measure protects hot water availability by requiring electric resistance backup heat when the compressor cutout temperature is above the local winter median of extremes. Other potential impacts on DIPs are discussed in Section 2, with impacts on potentially impacted populations as described in section 2.2.1.

8.6.2 Evolution of the Code Change Proposal and Future Opportunities

So far, this code change proposal has not evolved in response to feedback or needs of DIPs. The Statewide CASE Team seeks input from impacted populations and would collaborate with parties to consider revisions as appropriate. While the experiences of DIPs are different from those of the average consumer, the issues surrounding ventilation for HPWHs and the energy and cost savings resulting from providing adequate ventilation for HPWHs are clearly beneficial for DIPs (Hoeschele and Haile 2022).

However, though it is not in the purview of the Statewide CASE Team, there are costs associated with providing adequate ventilation. Though ventilation requirements are included in manufacturer install manuals, and contractors who have been meeting those requirements would not see their bid amounts rise due to this measure, the costs of providing adequate ventilation may not be adequately considered in incentive programs. Incentive programs should consider the cost of adequate ventilation, especially for affordable multifamily projects.

9. Individual DHW Electric Ready

9.1 Measure Description

9.1.1 Proposed Code Change

This measure would clean up and add to the existing mandatory requirements of Title 24, Part 6 Section 160.4 for all new construction multifamily buildings constructed with gas or propane individual water heaters. This measure adds or updates the following electric ready requirements:

- Electrical system components including the building service entrance conduit, meter panel, main service disconnect, and main distribution panel must be sized and installed to accommodate the future HPWH.
- The branch conductor size requirement is updated from requiring “a 120/240-volt 3 conductor, 10 AWG branch circuit” to requiring a 120/240-volt 3 conductor branch circuit rated to 30 amps minimum.
- Adequate physical space to accommodate the future HPWH.
- Adequate planning to meet the future HPWH ventilation needs, by reserving a future HPWH location with adequate volume as defined by the proposed code language, installing fixed openings, or by planning for future ducting to serve the HPWH.

The measure would also clean up the location of the electric ready language to move it from Section 160.4 to Section 160.9, which is where the other mandatory requirements for electric ready buildings are located.

Based on the findings from the multifamily research and stakeholder feedback, the Statewide CASE Team also proposes to improve the single family code language in Section 150.0(n). The Statewide CASE Team proposes to update the branch conductor size requirement, when the future HPWH would be within 3 feet from the water heater, from requiring “a 120/240-volt 3 conductor, 10 AWG branch circuit” to requiring a 120/240-volt 3 conductor branch circuit rated to 30 amps minimum.

9.1.2 Justification and Background Information

9.1.2.1 Justification

With federal, state, local, and utility incentive programs, and a cultural drive towards reducing carbon emissions, the market for HPWH in California has increased significantly over the last few years. Water heating accounts for 40 percent of natural gas consumption in the residential sector, representing 7 percent of the State’s total GHG emissions (E3 2019). Water heating energy use in multifamily buildings can

account for 27 to 32 percent of total energy use based on 2015 Residential Energy Consumption Survey by U.S. EIA. In 2022, Governor Gavin Newsom announced plans to expand California's climate change programs through CARB and the CEC, with goals to install six million heat pumps (including HPWH) by 2030 (Newsom 2022).

As market adoption of HPWH continues to increase, it is important that California ensures building owners of new construction multifamily buildings with gas or propane water heating equipment are enabled to easily adopt HPWHs in future retrofits. This is especially important since HPWHs can be two to three times more energy efficient than a fossil-gas or electric-resistance water heating system.

This proposal is intended to make future retrofits from gas or propane individual water heaters to individual HPWH more technically and financially feasible. The proposal would achieve this goal by updating the existing individual water heater electric ready requirements to address specific technical feasibility issues that are easier and lower cost to address at new construction, but that are not required by the current code. The technical feasibility issues that this proposal addresses include that HPWH systems typically require more physical space and higher ventilation rates than individual gas water heaters.

This proposal also cleans up the existing individual water heater electric ready requirements to bring them into alignment with existing electric ready requirements for multifamily buildings by:

- Updating the branch wiring sizing requirements from requiring “a 120/240-volt 3 conductor, 10 AWG branch circuit” to requiring a 120/240-volt 3 conductor branch circuit rated to 30 amps. This is consistent with other existing multifamily electric ready measures, and it addresses concerns that the existing requirements may not take into consideration the wide range of multifamily building layouts that could occur due to building layout and design variables, which may result in a higher voltage drop than is acceptable per Section 160.6(c).
- Moving the individual water heater electric ready requirements from Section 160.4 to Section 160.9, which is where the other electric ready requirements for multifamily buildings are located.

9.1.2.2 Background Information

Electric readiness is important to allow building owners the option to choose to install HPWH in the future. This is especially important given market trends of increasing HPWH adoption, and utility programs and reach codes which promote retrofit from gas individual water heaters to HPWH.

The 2022 Title 24, Part 6 code has existing electric ready requirements for gas uses including heat pump electric ready, cooktop electric ready, clothes drying electric ready, and individual water heating electric ready in multifamily buildings. The heat pump electric ready, cooktop electric ready, and clothes drying electric ready requirements are included in Section 160.9. The individual HPWH electric ready requirements are included in section 160.4. The individual HPWH electric ready requirements, which this proposal would improve, were adopted in the 2022 code cycle.

As of December 2022, at least 70 jurisdictions across California have adopted electric readiness and all-electric construction reach codes during the 2019 code cycle. Most of these jurisdictions require all-electric construction with no exception for water heating specifically. Some of these jurisdictions allow exceptions if a compliance pathway is not available under the 2022 Title 24 code, and a builder is not able to meet the performance compliance standards using commercially available electric technology. In this case, the jurisdiction would allow gas equipment and might also require electric readiness similar to the requirements of Title 24, Part 6 Section 160.9. Most of these jurisdictions that provide some exception for gas equipment in new construction have electric ready requirements including a branch circuit with receptacle or junction box within five feet of the gas appliance, appropriately sized conduit, reserved panel space, adequately sized electrical supply equipment and physical space.

California utilities also offer incentives for all-electric new construction in multifamily developments. These incentive programs have been available for the past three to four years. Most new construction multifamily buildings already have electric space conditioning, cooking and clothes drying and are mostly all-electric except for water heating. With programs such as these encouraging the adoption of all-electric homes including heat pump technology, developers are receiving design assistance support to learn how to design buildings with code compliant heat pumps and standardize the design practice.

9.1.3 Summary of Proposed Changes to Code Documents

The sections below summarize how the standards, Reference Appendices, ACM Reference Manuals, and compliance forms would be modified by the proposed change.⁹⁸ See Section 11 of this report for detailed proposed revisions to code language.

⁹⁸ Visit EnergyCodeAce.com for trainings, tools and resources to help people understand existing code requirements.

9.1.3.1 Specific Purpose and Necessity of Proposed Code Changes

Each proposed change to language in Title 24, Part 11 and Part 6 as well as the reference appendices to Part 6 are described below. See Section 11.2 of this report for marked-up code language.

Section: 150.0(n)

Specific Purpose: The specific purpose is to clean up the existing branch circuit sizing requirements to allow the designer to size the conductor.

Necessity: These changes are necessary to eliminate concerns that the current requirement is overly prescriptive and may interfere with electrical code requirements for branch circuit sizing in some cases.

Section: 160.4(d)

Specific Purpose: The specific purpose is to move the existing mandatory electric ready requirements code language to section 160.9 to better align with other existing multifamily electric ready requirements.

Necessity: These changes are necessary for consistency within the code

Section: 160.9(d)

Specific Purpose: The specific purpose is to update the existing mandatory electric ready requirements related to installation and design features required to facilitate future individual HPWHs, and to clean up the existing requirements to better align with existing multifamily other existing electric ready requirements.

Necessity: These changes are necessary to ensure that building owners with gas or propane individual water heaters can switch to energy efficient HPWHs in future retrofits

9.1.3.2 Specific Purpose and Necessity of Changes to the Nonresidential and Multifamily ACM Reference Manual

The proposed code change would not modify the ACM Reference Manual

9.1.3.3 Summary of Changes to the Nonresidential and Multifamily Compliance Manual

Chapter 11.10 of the Nonresidential and Multifamily Compliance Manual would need to be revised to update Section 11.10.1 What's New in 2022 Energy Code, and tables in Section 11.10 would need to be updated to include summary information about the additional electric ready requirements for individual HPWHs.

9.1.3.4 Summary of Changes to Compliance Forms

The proposed code change would modify the compliance forms listed below. Examples of the revised forms are presented in Section 11.5.

- **2022-LMCC-PLB-E: Domestic Water Heating:** Adds a mandatory requirement question on if the design team has met the electric ready requirements.
- **2022-NRCC-PLB-E: Domestic Water Heating:** Adds a mandatory requirement question on if the design team has met the electric ready requirements.
- **2022-LMCI-PLB-E: Domestic Water Heating:** Adds a mandatory requirement question on if the construction team has met the electric ready requirements.
- **2022-NRCI-PLB-E: Domestic Water Heating:** Adds a mandatory requirement question on if the construction team has met the electric ready requirements.

9.1.4 Regulatory Context

9.1.4.1 Determination of Inconsistency or Incompatibility with Existing State Laws and Regulations

This proposal builds on existing state building code (Title 24, Part 6). The Statewide CASE Team is not aware of incompatibility with any local laws. As described in section 9.1.2.2 Background Information, many jurisdictions have adopted local all electric code requirements that exceed the proposed electric ready requirements. These local codes should have a positive impact on the proposal by increasing market awareness of what infrastructure is required for all electric heat pump water heating equipment.

9.1.4.2 Duplication or Conflicts with Federal Laws and Regulations

There are no relevant federal laws or regulations.

9.1.4.3 Difference From Existing Model Codes and Industry Standards

There are no relevant industry standards or model codes.

9.1.5 Compliance and Enforcement

When developing this proposal, the Statewide CASE Team considered methods to streamline the compliance and enforcement process and how negative impacts on market actors who are involved in the process could be mitigated or reduced. This section describes how to comply with the proposed code change. It also describes the compliance verification process. Appendix E: Discussion of Impacts of Compliance Process on Market Actors presents how the proposed changes could impact various market actors.

The compliance verification activities related to this measure that need to occur during each phase of the project are described below:

- **Design Phase:**

- The plumbing engineer designs the plumbing systems including selecting the gas individual water heater, which triggers the proposed requirements. Current activities include specifying the gas equipment, and determining and coordinating space requirements, electrical requirements, equipment weight, and drainage piping locations to the rest of the design team. The proposal would require the plumbing engineer to also coordinate the code requirements for physical space and ventilation. The plumbing engineer would also coordinate with the energy consultant and add content to the applicable NRCC or LMCC compliance form based on the project details (see 9.1.3.4 Summary of Changes to Compliance Forms).
- The electrical engineer designs the electrical systems in the building. Currently, California Energy Code requires the electrical engineer to plan for a 10 AWG branch circuit to the future HPWH, but the electrical engineer is not explicitly required to size all upstream systems for the future load. This proposal would change current practice by requiring the electrical engineer to size the wire to meet a 30-amp load. The proposal would also explicitly require the electrical engineer to account for the electrical loads when sizing all building systems upstream of the dwelling-unit electric panel; this is already considered standard practice, but improving the code language would make the intent of the code clearer.

- **Permit Application Phase:**

- Plan checkers currently perform plan check reviews of the gas water heater systems and verify that the construction drawings meet the current individual HPWH electric ready requirements. The proposal would add new activities in this phase including requiring building officials to verify that the design team has met the code requirements for space, ventilation, and adequate sizing of electrical systems upstream of the dwelling-unit electrical panel. The LMCC and NRCC forms would assist the building officials in understanding which projects need to meet the proposed requirements.

- **Construction Phase:**

- General contractors are responsible for construction of the building, including hiring specialized subcontractors as required. Based on the new proposal, the general contractor's responsibilities would now include installing an appropriately sized closet, ensuring that the specified ventilation requirements are met, and coordinating with the construction team as needed to ensure the building is constructed adequately to meet the new requirements. The general contractor would also fill out the

applicable NRCI or LMCI compliance form based on the project details (see 9.1.3.4 Summary of Changes to Compliance Forms).

- Currently, the mechanical subcontractor is responsible for ensuring combustion air requirements are met, as specified by the mechanical engineer. Depending on how the design team plans to meet the proposed electric ready ventilation requirements, the mechanical contractor may also have to install ductwork to serve the future individual HPWH.
 - Currently, the electrical subcontractor is responsible for constructing the building electrical systems as specified by the electrical engineer. The responsibilities of the electrical subcontractor don't change significantly, although the proposal would generally result in larger/higher capacity electrical systems.
 - Currently, the plumbing subcontractor is typically responsible for installing the gas water heating system and any supporting systems such as the required condensate drainage piping, as specified by the plumbing engineer. The responsibilities of the plumbing subcontractor are not expected to change because of this proposal.
- **Inspection Phase:**
 - The inspector typically reviews the applicable NRCI or LMCI forms and verifies that the individual gas water heater meets all applicable building codes, including the existing electric ready requirements. This proposal would require the inspector to also verify that the following electric ready provisions meet the new code requirements for closet space, ventilation, and building electrical system sizing.

The compliance process for individual DHW electric ready requires new coordination activities in the design and construction phases, and it requires new inspection and plan checking activities. Compliance forms can be used to reduce the burden on the building official and building inspector, while ensuring the proposal is properly enforced. The compliance and enforcement activities are especially important for this proposal since the electric ready infrastructure would not affect the performance of the hot water system until the gas water heater is replaced with a HPWH.

9.2 Market Analysis

9.2.1 Current Market Structure

The Statewide CASE Team performed a market analysis with the goals of identifying current technology availability, current product availability, and market trends. It then considered how the proposed standard may impact the market in general as well as individual market actors. Information was gathered about the incremental cost of

complying with the proposed measure. Estimates of market size and measure applicability were identified through research and outreach with stakeholders including utility program staff, CEC staff, and a wide range of industry actors. In addition to conducting personalized outreach, the Statewide CASE Team discussed the current market structure and potential market barriers during a public stakeholder meeting(s) that the Statewide CASE Team held on February 17, 2023.

The main market actors include architects, building owners/developers, contractors, and design engineers.:

- **Building owners/developers:** Owners and developers are the ultimate decision-makers on the type of systems that go into their buildings. If the owners decide to install gas DHW system at the time of construction, they should be aware of the electric ready requirements and the cost associated to meet the requirement.
- **Architects:** Architects design the buildings and plan for the spaces where gas water heaters and electric ready components are installed. Decisions made by architects on the size and location of mechanical/plumbing areas, as well as other aspects of building layout, can significantly impact the feasibility of electric readiness. For example, if the architect reserves insufficient closet space for the future individual HPWH, the performance of the future individual HPWH could be negatively impacted due to ventilation and size constraints.
- **Plumbing engineers and design consultants:** Plumbing engineers (generally licensed mechanical engineers) are responsible for designing plumbing systems, including designing the individual gas DHW system and planning for future replacement with an individual HPWH. Sometimes plumbing consultants would influence the design, but the plumbing engineer is ultimately responsible for the performance of the plumbing systems. These professionals would need to understand the specific updates to the electric ready requirements including the updated electrical and ventilation requirements, and they coordinate these requirements to other members of the design team.
- **Electrical engineers:** Electrical engineers are responsible for designing electrical systems, including the building service entrance conduit, meter panel, main service disconnect, main distribution panel, and dedicated conduit from the panel to the planned location of the future HPWH equipment. Electrical engineers would need to size the electrical systems to meet the updated electric ready requirements.
- **Contractors:** Individual HPWH equipment is usually installed by the plumbing contractor, with some coordination by a general contractor and other trades. After installation, depending on the type of work, maintenance, and repairs of individual HPWH equipment may need to be performed by an HVAC contractor or other professional licensed to work with refrigerant-containing components.

9.2.2 Technical Feasibility and Market Availability

The Statewide CASE Team investigated the technical feasibility of electric ready requirements by understanding the installation approach and infrastructure difference between an individual gas and individual HPWH DHW system. The Statewide CASE Team conducted interviews and plan review to identify the necessary components that must be addressed at the time of construction and installation of the gas heater to facilitate retrofits to individual HPWH systems in the future to not be cost prohibitive.

- The Statewide CASE Team interviewed one general contractor, two design consultants, three designers, 1 plumbing contractor, 1 program implementer and 1 structural engineer to evaluate the individual HPWH design practices, understand the scope and approaches used to retrofit gas systems to HPWH systems, and identify the components that would be high cost and/or high impact at the time of the electrification retrofit.
- The Statewide CASE Team reviewed twenty projects with individual HPWH and two projects with individual gas water heaters to gather common design practices and challenges. Findings from plan review are consistent with the responses obtained from interview responses.
- The Statewide CASE Team interviewed a program implementer to explore the 120V individual HPWH options and whether the current electric ready requirements should be updated to include these products.
- The Statewide CASE Team reviewed literature from NEEA that included lab measured performance and modeling based on the lab testing of currently available 120V and 240V individual HPWH options. The Statewide CASE Team also performed outreach to the study author to further clarify certain details and further understand the report recommendations.

The results of The Statewide CASE Team's interviews were that ventilation, space, electrical, and condensate drainage are the most critical components to address at the time of construction for future retrofitting of an individual gas water heater system to an individual HPWH system. The current electric ready code already requires adequate condensate drainage, so the Statewide CASE Team focused on the ventilation, space, and electrical considerations. Four of six interviewees told the Statewide CASE Team that additional structural planning is not typically required for individual HPWH electric readiness, so the Statewide CASE Team does not propose requirements for structural planning.

In addition to market research, the Statewide CASE Team worked with an experienced plumbing design consultant firm to develop the BOD for non-electric ready and electric ready situations for retrofitting an individual gas water heater to an individual HPWH for the four multifamily prototype buildings. The BOD includes sizing, space, electrical, and

plumbing requirements, and the Statewide CASE Team used the BOD to perform analysis that support code requirement development around these technical aspects. For additional BOD specifications, see Table 526 and Table 539. The Statewide CASE Team also worked with an experienced electrical design consultant firm to understand standard practice around interpreting the existing electric ready requirements for individual HPWH. Based on work with this designer, the Statewide CASE Team established that standard practice includes sizing the entire building electrical system for the future load based on the existing electric ready requirements of Title 24 Part 6, Section 160.4.

9.2.2.1 Building level electrical system requirements

Any future retrofit from individual gas water heaters to individual HPWH would increase the peak demand on the buildings electrical system, including upstream of the dwelling unit main panel which is where the existing code language requirements end. The Statewide CASE Team worked with an experienced electrical engineer to determine that there are no existing building code requirements that explicitly require the electrical engineer to size the entire building electrical system to meet the future individual HPWH load or any other dwelling unit level electric ready load required by Title 24 Part 6, Section 160.9. The Statewide CASE Team determined, however, that standard design practice when planning for a future load is to size all upstream electrical components adequately for the future load. The Statewide CASE Team found that the technical feasibility of a future retrofit from gas to all-electric appliances, including individual HPWH, can be significantly compromised if standard design practice is not followed. For that reason, the Statewide CASE Team suggests improving the existing code language to explicitly require the entire building electrical system to be sized adequately for the future load. Appendix M includes a detailed description of the components of the building electrical system, and some of the specific technical feasibility concerns associated with each component.

9.2.2.2 Equipment Level Electrical Requirements

The Statewide CASE Team interviewed stakeholders, conducted market research and literature reviews, and developed electric ready plumbing and electrical system designs to develop improvements to the code requirements. One of the major technical considerations the Statewide CASE Team researched was whether the existing requirement for a 10 AWG copper branch circuit is appropriate for multifamily buildings where wire runs can exceed 100 feet. The other major technical considerations was whether the code should be updated to allow electric ready planning for 120-volt individual HPWH given that the Statewide CASE Team received stakeholder feedback that 120-volt individual HPWH have advanced significantly in the last few years.

The Statewide CASE Team proposal is to update the code language for branch circuit sizing to require a branch circuit rated to 30 amps. This change aligns the code language for individual HPWH electric ready with the electric ready code language for other equipment in section 160.9. This change also eliminates edge cases where the wiring exceeds 100 feet, and a 10 AWG copper branch circuit is not sufficient to meet the HPWH load. The Statewide CASE Team determined that the new requirement is functionally equivalent to the existing requirement in most cases by reviewing electrical drawings for 11 multifamily projects. In all the projects the Statewide CASE Team reviewed, the dwelling unit main panel is in the dwelling unit or adjacent to it, meaning that the installed branch circuit length is not likely to exceed 100 feet. Although the plans review shows that 100 feet branch circuit length is not likely to be exceeded under standard practice, the Statewide CASE Team still recommends improving the language to eliminate concerns in fringe cases where a 10 AWG copper branch circuit may not be adequate to serve the future load.

The Statewide CASE Team performed research to understand if 120-volt HPWH are appropriate for new construction, especially for mild climates and indoor installations. The Statewide CASE Team received spoke to designers, design consultants, and an experienced retrofit program implementer who works with 120-volt individual HPWH. The Team also conducted a literature review and reached out to the author of a NEEA report to inform our proposal. The Statewide CASE Team learned of the following benefits from stakeholders regarding 120-volt HPWH products:

- At least one 120-volt product can be plugged into an existing outlet, which could lead to reduced first costs for electrical infrastructure.
- There are at least two 120-volt individual HPWH currently on the market.
- 120-volt individual HPWH are a good fit for retrofits in buildings with low hot water demand where existing infrastructure cannot easily support a 240-volt individual HPWH

The Statewide CASE Team heard the following concerns from stakeholders regarding planning solely around 120-volt HPWH:

- The first hour recovery is lower for 120-volt systems compared to 240-volt systems, and
- They cannot be in exterior locations in cold climates because these systems do not have electrical back up, and
- The current 120-volt units use R134a refrigerant and have a compressor cut-off temperature of 38°F.

The Statewide CASE Team conducted product research to compare the current electrical requirements to a wide range of HPWH products to evaluate the range of the electrical impacts for code development. The Team found that there are more 240-volt HPWH on the market than 120-volt HPWH, meaning that the requirement to plan for 240 volts provides the building owner more flexibility in the future, since it is more feasible to install a 120-volt HPWH on a branch circuit that was originally intended for a 240 volt HPWH than it is to do the reverse.

Finally, the Statewide CASE Team learned about and reviewed a recent lab and modeling study by NEEA that includes critical site energy use and GHG emissions comparisons for 120 volt and 240-volt individual HPWH (Northwest Energy Efficiency Alliance 2022). Importantly, the NEEA report demonstrated that installation of 120-volt HPWH results in slightly higher overall site energy use and higher GHG emissions than installation of 240-volt HPWH, with an ambient air condition of 67.5 °F. The NEEA report also recommends that the currently available 120-volt HPWH products are most suited to existing buildings that have infrastructure limitations, and that currently 240-volt products are more appropriate for new construction including new electric ready construction. Since the existing electric ready code already requires planning for 240-volt HPWH, changing the code to allow planning for 120-volt HPWH in certain mild climates (or for completely indoor installations) would increase energy use and represent a rollback of existing code requirements at odds with the intent of the energy code. The current 120-volt HPWH market is still emerging, and it could be appropriate to re-visit this requirement in the future; currently, however, the Statewide CASE Team recommends against changing the current requirements for individual HPWH electric readiness to allow planning for 120-volt options since it would reduce the owner's future equipment options while increasing site energy use and GHG emissions.

9.2.2.3 Space Requirements

Currently, the electric ready requirements for individual HPWH do not have any specific space requirements even though individual HPWH have tanks and require a larger installation space compared to the prescriptively required gas tankless systems. The Statewide CASE Team received feedback from stakeholder interviews that the space required for an individual HPWH is generally greater than the space required for a gas water heater due in part to the compressor. The Statewide CASE Team leveraged the interview data, data from plans review of new construction projects with individual HPWH, and input from an experienced plumbing design engineer to inform the code requirements. The Statewide CASE Team proposes a minimum space requirement of 39" x 39" x 96" as part of the electric ready requirements; The Statewide CASE Team heard in interviews that HPWH are larger and require more space than instantaneous gas water heaters. For instance, one HPWH we reviewed is 27" x 27" x 69". This compares to instantaneous gas water heaters where the closets can be significantly

smaller due to the smaller dimensions of the water heater (for instance, one product reviewed is 18"x18"x28"). The Statewide CASE Team asked for stakeholder feedback in a stakeholder meeting on February 17th, and received zero responses that the reserved space requirements are too high and one comment in support of more stringent requirements than proposed, including a higher "closet volume".

9.2.2.4 Ventilation Requirements

Individual HPWH require adequate ventilation to function properly. Furthermore, as described in Section 8.2.2, the Statewide CASE Team found in a review of projects that HPWHs are often installed with inadequate ventilation. Therefore, the Statewide CASE Team proposes to add ventilation requirements to the electric ready code. There are three generally accepted ventilation strategies including:

- Install HPWH in an adequately large space, or
- Install a fully louvered door or grilles that vent directly from the water heater closet to an adequately large space or outdoors.
- Install ducted ventilation of supply and exhaust from the HPWH to a larger space or to the outdoors.

Each of the ventilation strategies listed pose a challenge when implemented at retrofit. Increasing the size of a closet or adding 8" duct work from the HPWH location to an acceptable location may not be technically feasible due to space limitations. Additionally, adding duct terminations to the exterior could trigger additional review by the AHJ for planning purposes. In a retrofit situation, the existing flue for the gas water heater cannot be utilized since flue sizes are typically 3" or 4" and do not have adequate cross-sectional area to meet the ventilation requirements. The simplest retrofit option would be to retrofit grilles or louvers at the time of future install; however, this may not be appropriate for all situations. The Statewide CASE Team heard from some stakeholders that over cooling of small spaces can be a concern when the HPWH closet is ventilated to a small space; The requirement to plan for ventilation at new construction gives the original design team the opportunity to consider the tradeoffs of each ventilation method and choose the most appropriate ventilation method at new construction.

9.2.2.5 Plumbing Requirements

The current electric ready requirements include a requirement for a condensate drain, although a size requirement is not specified. Based on section 814.3 of the California Plumbing Code, which regulates the sizing of condensate waste pipes from air-cooling coils, the minimum condensate pipe diameter allowed by the plumbing code is 3/4", which can serve up to 20 tons of refrigeration capacity. Compressor capacity for individual HPWH typically does not exceed 1 ton, and the Statewide CASE Team is not

aware of any individual HPWH product for which a ¾” condensate drainage pipe would not be adequate. Therefore, the Statewide CASE Team does not recommend updating the language to include a pipe size.

9.2.3 Market Impacts and Economic Assessments

9.2.3.1 Impact on Builders

Builders of residential and commercial structures are directly impacted by many of the measures proposed by the Statewide CASE Team for the 2025 code cycle. It is within the normal practices of these businesses to adjust their building practices to changes in building codes. When necessary, builders engage in continuing education and training to remain compliant with changes to design practices and building codes.

California’s construction industry comprises approximately 93,000 business establishments and 943,000 employees (see Table 327). For 2022, total estimated payroll would be about \$78 billion. Nearly 72,000 of these business establishments and 473,000 employees are engaged in the residential building sector, while another 17,600 establishments and 369,000 employees focus on the commercial sector. The remainder of establishments and employees work in industrial, utilities, infrastructure, and other heavy construction roles (the industrial sector).

Table 327: California Construction Industry, Establishments, Employment, and Payroll in 2022 (Estimated)

Building Type	Construction Sectors	Establishments	Employment	Annual Payroll (Billions \$)
Residential	All	71,889	472,974	31.2
Residential	Building Construction Contractors	27,948	130,580	9.8
Residential	Foundation, Structure, & Building Exterior	7,891	83,575	5.0
Residential	Building Equipment Contractors	18,108	125,559	8.5
Residential	Building Finishing Contractors	17,942	133,260	8.0
Commercial	All	17,621	368,810	35.0
Commercial	Building Construction Contractors	4,919	83,028	9.0
Commercial	Foundation, Structure, & Building Exterior	2,194	59,110	5.0
Commercial	Building Equipment Contractors	6,039	139,442	13.5
Commercial	Building Finishing Contractors	4,469	87,230	7.4

Building Type	Construction Sectors	Establishments	Employment	Annual Payroll (Billions \$)
Industrial, Utilities, Infrastructure, & Other (Industrial+)	All	4,206	101,002	11.4
Industrial+	Building Construction	288	3,995	0.4
Industrial+	Utility System Construction	1,761	50,126	5.5
Industrial+	Land Subdivision	907	6,550	1.0
Industrial+	Highway, Street, and Bridge Construction	799	28,726	3.1
Industrial+	Other Heavy Construction	451	11,605	1.4

Source: (State of California n.d.)

The proposed changes to individual DHW electric ready would likely affect residential builders but would not impact firms that focus on construction and retrofit of industrial buildings, utility systems, public infrastructure, or other heavy construction. The effects on the residential and commercial building industry would not be felt by all firms and workers, but rather would be concentrated in specific industry subsectors. Table 327 shows the residential and commercial building subsectors the Statewide CASE Team expects to be impacted by the changes proposed in this report. The additional space and equipment necessary to accommodate this measure in new construction would cause changes to building design. The Statewide CASE Team’s estimates of the magnitude of these impacts are shown in Section 9.2.4 Economic Impacts.

Table 328: Specific Subsectors of the California Residential Building Industry by Subsector in 2022 (Estimated)

Residential Building Subsector	Establishments	Employment	Annual Payroll (Billions \$)
New multifamily general contractors	421	6,344	0.7
New housing for-sale builders	189	3,969	0.5
Residential plumbing and HVAC contractors	9,852	75,404	5.1

Source: (State of California n.d.)

9.2.3.2 Impact on Building Designers and Energy Consultants

Adjusting design practices to comply with changing building codes is within the normal practices of building designers. Building codes (including Title 24, Part 6) are typically updated on a three-year revision cycle and building designers and energy consultants engage in continuing education and training in order to remain compliant with changes to design practices and building codes.

For this proposal, newly constructed buildings would require more space for the installation of a future HPWH. Architects and plumbing engineers would likely require some training on the space requirements as well as ventilation requirements for the HPWH. Architects could also benefit from a professional association that might incorporate a townhall discussion as how to make optimum use of the reduced space they have for the dwelling units they design. HVAC designers would need to learn the ventilation requirements, and General Contractors as well could potentially benefit from some training as to how to deal with bidding the additional materials necessary.

Businesses that focus on residential, commercial, institutional, and industrial building design are contained within the Architectural Services sector (North American Industry Classification System 541310). Table 329 shows the number of establishments, employment, and total annual payroll for Building Architectural Services. The proposed code changes would potentially impact all firms within the Architectural Services sector. The Statewide CASE Team anticipates the impacts for individual DHW electric ready to affect firms that focus on multifamily construction.

There is not a NAICS⁹⁹ code specific to energy consultants. Instead, businesses that focus on consulting related to building energy efficiency are contained in the Building Inspection Services sector (NAICS 541350), which is comprised of firms primarily engaged in the physical inspection of residential and nonresidential buildings.¹⁰⁰ It is not possible to determine which business establishments within the Building Inspection Services sector are focused on energy efficiency consulting. The information shown in Table 329 provides an upper bound indication of the size of this sector in California.

Table 329: California Building Designer and Energy Consultant Sectors in 2022 (Estimated)

Sector	Establishments	Employment	Annual Payroll (Millions \$)
Architectural Services^a	4,134	31,478	3,623.3
Building Inspection Services^b	1,035	3,567	280.7

⁹⁹ NAICS is the standard used by federal statistical agencies in classifying business establishments for the purpose of collecting, analyzing, and publishing statistical data related to the U.S. business economy. NAICS was developed jointly by the U.S. Economic Classification Policy Committee (ECPC), Statistics Canada, and Mexico's Instituto Nacional de Estadística y Geografía, to allow for a high level of comparability in business statistics among the North American countries. NAICS replaced the Standard Industrial Classification (SIC) system in 1997.

¹⁰⁰ Establishments in this sector include businesses primarily engaged in evaluating a building's structure and component systems and includes energy efficiency inspection services and home inspection services. This sector does not include establishments primarily engaged in providing inspections for pests, hazardous wastes or other environmental contaminants, nor does it include state and local government entities that focus on building or energy code compliance/enforcement of building codes and regulations.

Source: (State of California n.d.)

- a. Architectural Services (NAICS 541310) comprises private-sector establishments primarily engaged in planning and designing residential, institutional, leisure, commercial, and industrial buildings and structures.
- b. Building Inspection Services (NAICS 541350) comprises private-sector establishments primarily engaged in providing building (residential & nonresidential) inspection services encompassing all aspects of the building structure and component systems, including energy efficiency inspection services.

9.2.3.3 Impact on Occupational Safety and Health

The proposed code change does not alter any existing federal, state, or local regulations pertaining to safety and health, including rules enforced by the California DOSH. All existing health and safety rules would remain in place. Complying with the proposed code change is not anticipated to have adverse impacts on the safety or health of occupants or those involved with the construction, commissioning, and maintenance of the building.

9.2.3.4 Impact on Building Owners and Occupants Including Homeowners and Potential First-Time Homeowners

Residential Buildings

According to data from the U.S. Census ACS, there were more than 14.5 million housing units in California in 2021 and nearly 13.3 million were occupied (see Table 330). Most housing units (nearly 9.42 million) were single family homes (either detached or attached), approximately 2 million homes were in buildings containing two to nine units, and 2.5 million homes were in multifamily buildings containing 10 or more units. The California Department of Revenue estimated that building permits for 67,300 single family and 54,900 multifamily homes would be issued in 2022, up from 66,000 single family and 53,500 multifamily permits issued in 2021.

Table 330: California Housing Characteristics in 2021^a

Housing Measure	Estimate
Total housing units	14,512,281
Occupied housing units	13,291,541
Vacant housing units	1,220,740
Homeowner vacancy rate	0.7%
Rental vacancy rate	4.3%
Number of 1-unit, detached structures	8,388,099
Number of 1-unit, attached structures	1,030,372
Number of 2-unit structures	348,295
Number of 3- or 4-unit structures	783,663
Number of 5- to 9-unit structures	856,225
Number of 10- to 19-unit structures	740,126

Housing Measure	Estimate
Number of 20+ unit structures	1,828,547
Mobile home, RV, etc.	522,442

Sources: (United States Census Bureau n.d.), (Federal Reserve Economic Data (FRED) n.d.)

- a. Total housing units as reported for 2021; all other housing measures estimated based on historical relationships.

Table 331 shows the distribution of California homes by vintage. About 15 percent of California homes were built in 2000 or later and another 11 percent built between 1990 and 1999. The majority of California’s existing housing stock (8.5 million homes – 59 percent of the total) were built between 1950 and 1989, a period of rapid population and economic growth in California. Finally, about 2.1 million homes in California were built before 1950. According to Kenney et al, 2019, more than half of California’s existing multifamily buildings (those with five or more units) were constructed before 1978 when there was no California Energy Code (Kenney 2019).

Table 331: Distribution of California Housing by Vintage in 2021 (Estimated)

Home Vintage	Units	Percent	Cumulative Percent
Built 2014 or later	348,296	2.4	2.4
Built 2010 to 2013	261,221	1.8	4.2
Built 2000 to 2009	1,581,839	10.9	15.1
Built 1990 to 1999	1,596,351	11.0	26.1
Built 1980 to 1989	2,191,354	15.1	41.2
Built 1970 to 1979	2,539,649	17.5	58.7
Built 1960 to 1969	1,915,621	13.2	71.9
Built 1950 to 1959	1,930,133	13.3	85.2
Built 1940 to 1949	841,712	5.8	91.0
Built 1939 or earlier	1,306,105	9.0	100.0
Total housing units	14,512,281	100.0	–

Sources: (United States Census Bureau n.d.), (Federal Reserve Economic Data (FRED) n.d.)

Table 332 shows the distribution of owner- and renter-occupied housing by household income. Overall, about 55 percent of California housing is owner-occupied and the rate of owner-occupancy generally increases with household income. The owner-occupancy rate for households with an income below \$50,000 is only 37 percent, whereas the owner occupancy rate is 71 percent for households earning \$100,000 or more.

Table 332: Owner- and Renter-Occupied Housing Units in California by Income in 2021 (Estimated)

Household Income	Total	Owner Occupied	Renter Occupied
Less than \$5,000	353,493	113,315	240,178

Household Income	Total	Owner Occupied	Renter Occupied
\$5,000 to \$9,999	254,304	74,939	179,366
\$10,000 to \$14,999	495,287	134,633	360,654
\$15,000 to \$19,999	412,498	144,064	268,435
\$20,000 to \$24,999	467,694	169,431	298,264
\$25,000 to \$34,999	906,996	355,968	551,028
\$35,000 to \$49,999	1,319,892	560,453	759,438
\$50,000 to \$74,999	2,036,560	990,769	1,045,791
\$75,000 to \$99,999	1,662,032	920,607	741,425
\$100,000 to \$149,999	2,307,889	1,490,247	817,642
\$150,000 or more	3,074,895	2,337,651	737,244
Total Housing Units	13,291,541	7,292,076	5,999,465

Source: (United States Census Bureau n.d.), (Federal Reserve Economic Data (FRED) n.d.)

Understanding the distribution of California residents by home type, home vintage, and household income is critical for developing meaningful estimates of the economic impacts associated with proposed code changes affecting residents. Many proposed code changes specifically target single family or multifamily residences and so the counts of housing units by building type shown in Table 330. Table 330 provides the information necessary to quantify the magnitude of potential impacts. Likewise, impacts may differ for owners and renters, by home vintage, and by household income, information provided in Table 331 and Table 332.

Estimating Impacts

The Statewide CASE Team estimates that on average the proposed change to Title 24, Part 6 would increase construction cost by about \$179 per multifamily dwelling unit. However, despite the additional cost and that the measure would present no energy savings, the net incremental present value does show a savings to consumers of between \$512-\$600 over the life of the water heater and is cost effective.

9.2.3.5 Impact on Building Component Retailers (Including Manufacturers and Distributors)

The Statewide CASE Team anticipates the proposed change would cause a marginal increase in grille sales for HVAC retailers.

9.2.3.6 Impact on Building Inspectors

Table 333 shows employment and payroll information for state and local government agencies in which many inspectors of residential and commercial buildings are employed. Building inspectors participate in continuing education and training to stay current on all aspects of building regulations, including energy efficiency. The Statewide CASE Team, therefore, anticipates the proposed change would represent a minimal

increase on employment of building inspectors or the scope of their role conducting energy efficiency inspections.

Table 333: Employment in California State and Government Agencies with Building Inspectors in 2022 (Estimated)

Sector	Govt.	Establishments	Employment	Annual Payroll (Million \$)
Administration of Housing Programs ^a	State	18	265	29.0
	Local	38	3,060	248.6
Urban and Rural Development Admin ^b	State	38	764	71.3
	Local	52	2,481	211.5

Source: (State of California, Employment Development Department n.d.)

- a. Administration of Housing Programs (NAICS 925110) comprises government establishments primarily engaged in the administration and planning of housing programs, including building codes and standards, housing authorities, and housing programs, planning, and development.
- b. Urban and Rural Development Administration (NAICS 925120) comprises government establishments primarily engaged in the administration and planning of the development of urban and rural areas. Included in this industry are government zoning boards and commissions.

9.2.3.7 Impact on Statewide Employment

As described in Sections 9.2.3.1 through 9.2.3.6, the Statewide CASE Team does not anticipate significant employment or financial impacts to any sector of the California economy. This is not to say that the proposed change would not have modest impacts on employment in California. In Section 9.2.4, the Statewide CASE Team estimated the proposed change in individual DWH electric ready would affect statewide employment and economic output directly and indirectly through its impact on builders, designers and energy consultants, and building inspectors. In addition, the Statewide CASE Team estimated how energy savings associated with the proposed change in individual DWH electric ready would lead to modest ongoing financial savings for California residents, which would then be available for other economic activities.

9.2.4 Economic Impacts

For the 2025 code cycle, the Statewide CASE Team used the IMPLAN model software¹⁰¹, along with economic information from published sources, and professional judgement to develop estimates of the economic impacts associated with each of the proposed code changes. Conceptually, IMPLAN estimates jobs created as a function of incoming cash flow in different sectors of the economy, due to implementing a code or a

¹⁰¹ IMPLAN employs economic data and advanced economic impact modeling to estimate economic impacts for interventions like changes to the California Title 24, Part 6 code. For more information on the IMPLAN modeling process, see www.IMPLAN.com.

standard. The jobs created are typically categorized into direct, indirect, and induced employment. For example, cash flow into a manufacturing plant captures direct employment (jobs created in the manufacturing plant), indirect employment (jobs created in the sectors that provide raw materials to the manufacturing plant) and induced employment (jobs created in the larger economy due to purchasing habits of people newly employed in the manufacturing plant). Eventually, IMPLAN computes the total number of jobs created due to a code. The assumptions of IMPLAN include constant returns to scale, fixed input structure, industry homogeneity, no supply constraints, fixed technology, and constant byproduct coefficients. The model is also static in nature and is a simplification of how jobs are created in the macro-economy.

The economic impacts developed for this report are only estimates and are based on limited and to some extent speculative information. The IMPLAN model provides a relatively simple representation of the California economy and, though the Statewide CASE Team is confident that the direction and approximate magnitude of the estimated economic impacts are reasonable, it is important to understand that the IMPLAN model is a simplification of extremely complex actions and interactions of individual, businesses, and other organizations as they respond to changes in energy efficiency codes. In all aspect of this economic analysis, the CASE Authors rely on conservative assumptions regarding the likely economic benefits associated with the proposed code change. By following this approach, the economic impacts presented below represent lower bound estimates of the actual benefits associated with this proposed code change.

Adoption of this code change proposal would result in relatively modest economic impacts through the additional direct spending by those in the residential building and remodeling industry as well as indirectly as residents spend all or some of the money saved through lower utility bills on other economic activities.¹⁰² There may also be some nonresidential customers that are impacted by this proposed code change; however, the Statewide CASE Team does not anticipate such impacts to be materially important to the building owner and would have measurable economic impacts.

¹⁰² For example, for the lowest income group, the Statewide CASE Team assumes 100 percent of money saved through lower energy bills would be spent, while for the highest income group, the Statewide CASE Team assumes only 64 percent of additional income would be spent.

Table 334: Estimated Impact that Adoption of the Proposed Measure would have on the California Residential Sector

Type of Economic Impact	Employment (Jobs)	Labor Income	Total Value Added	Output
Direct Effects (Additional spending by Residential Builders)	59.0	\$4,673,592	\$4,732,217	\$5,771,112
Indirect Effect (Additional spending by firms supporting Residential builders)	5.4	\$408,195	\$664,838	\$1,146,542
Induced Effect (Spending by employees of firms experiencing “direct” or “indirect” effects)	21.9	\$1,496,368	\$2,679,017	\$4,263,973
Total Economic Impacts	86.3	\$6,578,155	\$8,076,073	\$11,181,628

Source: Statewide CASE Team analysis of data from the IMPLAN modeling software.¹⁰³

Table 335: Estimated Impact that Adoption of the Proposed Measure would have on the California Building Designers and Energy Consultants Sectors

Type of Economic Impact	Employment (Jobs)	Labor Income	Total Value Added	Output
Direct Effects (Additional spending by Building Designers & Energy Consultants)	5.0	\$547,618	\$542,135	\$856,896
Indirect Effect (Additional spending by firms supporting Bldg. Designers & Energy Consultants)	2.0	\$163,053	\$226,612	\$364,798
Induced Effect (Spending by employees of firms experiencing “direct” or “indirect” effects)	3.0	\$204,351	\$365,949	\$582,461
Total Economic Impacts	10.0	\$915,022	\$1,134,696	\$1,804,155

Source: Statewide CASE Team analysis of data from the IMPLAN modeling software.

Table 336: Estimated Impact that Adoption of the Proposed Measure would have on California Building Inspectors

Type of Economic Impact	Employment (Jobs)	Labor Income	Total Value Added	Output
Direct Effects (Additional spending by Building Inspectors)	0.3	\$33,153	\$39,315	\$47,776
Indirect Effect (Additional spending by firms supporting Building Inspectors)	0.0	\$3,070	\$4,782	\$8,329
Induced Effect (Spending by employees of Building Inspection Bureaus and Departments)	0.2	\$10,428	\$18,679	\$29,731
Total Economic Impacts	0.5	\$46,651	\$62,776	\$85,836

Source: Statewide CASE Team analysis of data from the IMPLAN modeling software.

¹⁰³ IMPLAN® model, 2020 Data, IMPLAN Group LLC, IMPLAN System (data and software), 16905 Northcross Dr., Suite 120, Huntersville, NC 28078 www.IMPLAN.com

9.2.4.1 Creation or Elimination of Jobs

The Statewide CASE Team does not anticipate that the measures proposed for the 2025 code cycle regulation would lead to the creation of new *types* of jobs or the elimination of *existing* types of jobs. In other words, the Statewide CASE Team’s proposed change would not result in economic disruption to any sector of the California economy. Rather, the estimates of economic impacts discussed in Section 9.2.4 would lead to modest changes in employment of existing jobs.

9.2.4.2 Creation or Elimination of Businesses in California

As stated in Section 9.2.4.1, the Statewide CASE Team’s proposed change would not result in economic disruption to any sector of the California economy. The proposed change represents a modest change to building and electric design, which would not excessively burden or competitively disadvantage California businesses—nor would it necessarily lead to a competitive advantage for California businesses. Therefore, the Statewide CASE Team does not foresee any new businesses being created, nor does the Statewide CASE Team think any existing businesses would be eliminated due to the proposed code changes.

9.2.4.3 Competitive Advantages or Disadvantages for Businesses in California

The proposed code changes would apply to all businesses incorporated in California, regardless of whether the business is located inside or outside of the state.¹⁰⁴ Therefore, the Statewide CASE Team does not anticipate that these measures proposed for the 2025 code cycle regulation would have an adverse effect on the competitiveness of California businesses. Likewise, the Statewide CASE Team does not anticipate businesses located outside of California would be advantaged or disadvantaged.

9.2.4.4 Increase or Decrease of Investments in the State of California

The Statewide CASE Team analyzed national data on corporate profits and capital investment by businesses that expand a firm’s capital stock (referred to as net private domestic investment, or NPDI).¹⁰⁵ As Table 337 shows, between 2017 and 2021, NPDI as a percentage of corporate profits ranged from a low of 18 in 2020 due to the worldwide economic slowdowns associated with the COVID 19 pandemic to a high of 35 percent in 2019, with an average of 26 percent. While only an approximation of the

¹⁰⁴ Gov. Code, §§ 11346.3(c)(1)(C), 11346.3(a)(2); 1 CCR § 2003(a)(3) Competitive advantages or disadvantages for California businesses currently doing business in the state.

¹⁰⁵ Net private domestic investment is the total amount of investment in capital by the business sector that is used to expand the capital stock, rather than maintain or replace due to depreciation. Corporate profit is the money left after a corporation pays its expenses.

proportion of business income used for net capital investment, the Statewide CASE Team believes it provides a reasonable estimate of the proportion of proprietor income that would be reinvested by business owners into expanding their capital stock.

Table 337: Net Domestic Private Investment and Corporate Profits, U.S.

Year	Net Domestic Private Investment by Businesses, Billions of Dollars	Corporate Profits After Taxes, Billions of Dollars	Ratio of Net Private Investment to Corporate Profits (Percent)
2017	518.473	1882.460	28
2018	636.846	1977.478	32
2019	690.865	1952.432	35
2020	343.620	1908.433	18
2021	506.331	2619.977	19
5-Year Average	-	-	26

Source: (Federal Reserve Economic Data (FRED) n.d.)

The Statewide CASE Team does not anticipate that the economic impacts associated with the proposed measure would lead to significant change (increase or decrease) in investment, directly or indirectly, in any affected sectors of California’s economy. Nevertheless, the Statewide CASE Team can derive a reasonable estimate of the change in investment by California businesses based on the estimated change in economic activity associated with the proposed measure and its expected effect on proprietor income, which the Statewide CASE Team use a conservative estimate of corporate profits, a portion of which the Statewide CASE Team assume would be allocated to net business investment.¹⁰⁶

9.2.4.5 Incentives for Innovation in Products, Materials, or Processes

This proposal could increase designer familiarity with the basic infrastructure needs of an individual HPWH and therefore promote overall adoption of HPWH in the long term.

9.2.4.6 Effects on the State General Fund, State Special Funds, and Local Governments

The Statewide CASE Team does not expect the proposed code changes would have a measurable impact on the California’s General Fund, any state special funds, or local government funds.

¹⁰⁶ 26 percent of proprietor income was assumed to be allocated to net business investment; see Table 272.

Cost of Enforcement

Cost to the State: State government already has budget for code development, education, and compliance enforcement. While state government would be allocating resources to update the Title 24, Part 6 Standards, including updating education and compliance materials and responding to questions about the revised requirements, these activities are already covered by existing state budgets. The costs to state government are small when compared to the overall costs savings and policy benefits associated with the code change proposals. This proposal is limited to residential buildings and does not impact state buildings.

Cost to Local Governments: All proposed code changes to Title 24, Part 6 would result in changes to compliance determinations. Local governments would need to train building department staff on the revised Title 24, Part 6 Standards. While this re-training is an expense to local governments, it is not a new cost associated with the 2025 code change cycle. The building code is updated on a triennial basis, and local governments plan and budget for retraining every time the code is updated. There are numerous resources available to local governments to support compliance training that can help mitigate the cost of retraining, including tools, training and resources provided by the IOU Codes and Standards program (such as Energy Code Ace). As noted in Section 9.1.5 and Appendix E, the Statewide CASE Team considered how the proposed code change might impact various market actors involved in the compliance and enforcement process and aimed to minimize negative impacts on local governments.

9.2.4.7 Impacts on Specific Persons

While the objective of any of the Statewide CASE Team's proposal is to promote energy efficiency, the Statewide CASE Team recognizes that there is the potential that a proposed code change may result in unintended consequences. However, the Team does not expect any group to be impacted any differently than any other. Refer to Section 9.6 for more details addressing energy equity and environmental justice.

9.2.5 Fiscal Impacts

9.2.5.1 Mandates on Local Agencies or School Districts

There are no relevant mandates to school districts because this proposal only impacts multifamily buildings. There are also no mandates for local agencies because the requirements would be specified at the statewide level through Title 24, Part 6.

9.2.5.2 Costs to Local Agencies or School Districts

There are no costs to school districts because this proposal only impacts multifamily buildings. For local agencies The Statewide CASE Team does not anticipate any increase in work for building inspectors.

9.2.5.3 Costs or Savings to Any State Agency

There are no costs or savings to state agencies because this proposal only impacts multifamily buildings and state agencies would not be involved in enforcement of the measure.

9.2.5.4 Other Non-Discretionary Cost or Savings Imposed on Local Agencies

There are no added non-discretionary costs or savings to local agencies because this proposal only impacts multifamily buildings.

9.2.5.5 Costs or Savings in Federal Funding to the State

There are no costs or savings to federal funding to the state due to the measure. The proposed measure is a relatively small cost which the market would bear. The state would not require federal funding to implement the proposed measure.

9.3 Energy Savings

There are no energy savings for this measure.

9.4 Cost and Cost-Effectiveness

9.4.1 Energy Cost Savings Methodology

The code change proposal would not directly result in immediate energy savings, so there are no reported savings on a per-unit basis. Section 9.4.1 of the CASE Report has been truncated for this proposal.

9.4.2 Energy Cost Savings Results

The code change proposal would not directly result in immediate energy savings, so there are no reported savings on a per-unit basis. Section 9.4.2 of the CASE Report has been truncated for this proposal.

9.4.3 Incremental First and Retrofit Cost

This measure proposes improvements to the existing electric ready code requirements for individual HPWH for components necessary to avoid costly and technically challenging future retrofits from individual gas to individual HPWH equipment. The Statewide CASE Team considered first cost, which is the cost at time of construction, and future retrofit costs which includes the future retrofit cost for both electric ready and non-electric ready existing water heating systems. The Statewide CASE Team determined Cost-Effectiveness for the improved electric ready measure as the cost savings between installing improved electric ready components at the time of

construction compared to retrofit costs for an improved electric ready system. The Statewide CASE Team summarized these situations and definitions in Figure 24 below):

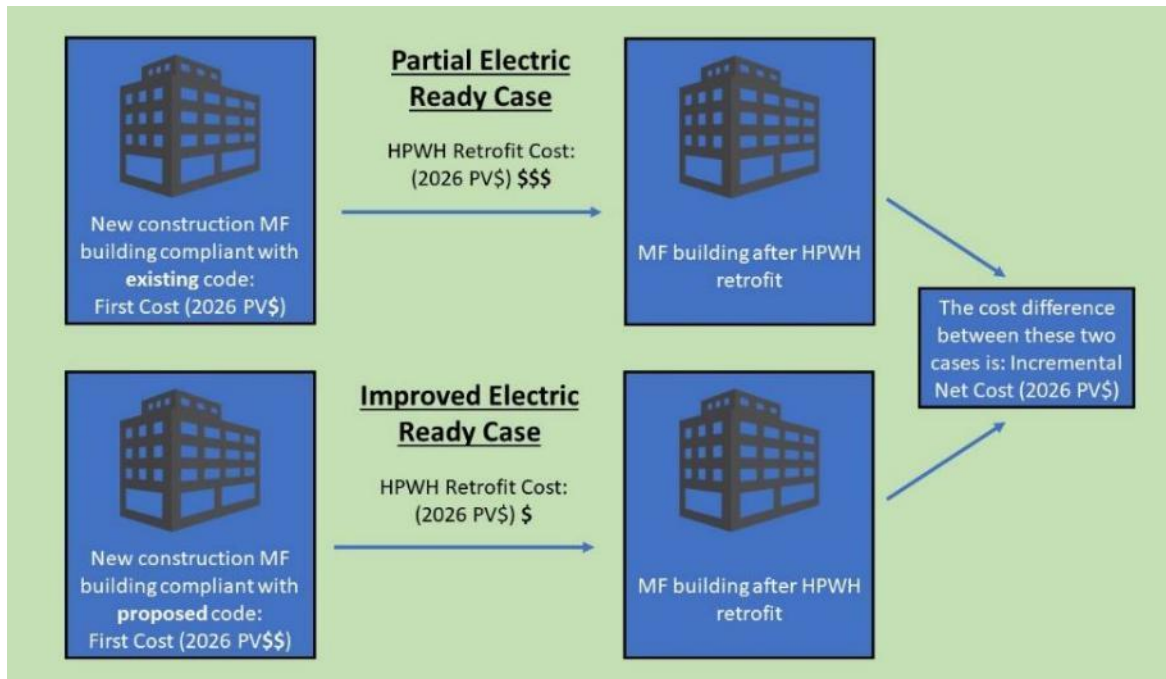

Figure 24: Electric ready cases.

Incremental first cost at time of new construction:

- Base Case (Partial Electric Ready Case): Cost of each component using standard practices and meeting the existing code requirements of Title 24 Part 6 for individual electric ready HPWH. In this report, the Statewide CASE Team refers to this case as “Base Case New Construction.”
- Proposed Case (Improved Electric Ready Case): Cost of each component based on the proposed improved planning for heat pump water heating in the future. (i.e., augmented water heater closet size, and heat pump water heater ventilation). In this report the Statewide CASE Team refers to this case as “Proposed Case New Construction”.

Incremental first cost was calculated as:

$$\begin{aligned} \text{Incremental First Cost} \\ = \text{Proposed Case New Construction} - \text{Base Case New Construction} \end{aligned}$$

Equation 1: Incremental First Cost

Incremental retrofit cost at time of electrification retrofit:

- Base Case (Partial Electric Ready Case): Incremental cost of implementing each retrofit component when the existing building met existing electric ready code requirements. In this report the Statewide CASE Team refers to this case as “Base Case Retrofit”.
- Proposed Case (Improved Electric Ready Case): Incremental cost of implementing each retrofit when the existing building met the proposed electric ready code requirements. In this report the Statewide CASE Team refers to this case as “Proposed Case Retrofit”. The Statewide CASE Team determined that all future costs incurred at time of retrofit for the Proposed Case Retrofit would also be incurred at time of the Base Case Retrofit, and so the incremental cost associated with the proposal at time of retrofit is \$0.

Incremental retrofit cost is calculated as follows:

$$\text{Incremental Retrofit Cost} = \text{Proposed Case Retrofit} - \text{Base Case Retrofit}$$

Equation 2: Incremental Retrofit Cost

Incremental first costs are assumed to be valued at 2026 present value (PV), while incremental retrofit costs, which are incurred in the future, need to be adjusted to 2026 PV with Equation 3 adjusted via 2026 PV. The present value of equipment retrofit costs (or savings) was calculated using a three percent discount rate (d), which is consistent with the discount rate used when developing the 2025 Lifecycle Cost Hourly Factors. The present value of retrofit costs that occurs in the n^{th} year is calculated as follows:

$$\text{Present Value of Incremental Retrofit Cost} = \text{Incremental Retrofit Cost} \times \left[\frac{1}{1 + d} \right]^n$$

Equation 3: Incremental Retrofit Cost 2026 Present Value Calculation

The Statewide CASE Team assumed the electrification retrofit would occur on year 20. Building on research findings presented in Section 9.2.2, the Statewide CASE Team identified the greatest barriers to future retrofit of an individual HPWH which are listed below:

1. Water Heater Closet Space Augmentation (material and labor)
2. Water Heater Closet Door Ventilation Grilles Installation (material and labor)
3. Markups for overhead and profit

The Statewide CASE Team worked with an experienced plumbing design consultant firm and an experienced electrical design consultant firm to develop the BOD for partial

electric ready (base case) and improved electric ready (proposed) situations for retrofitting an individual gas water heater to an individual HPWH for the four multifamily prototype buildings. The BOD includes equipment sizing, space requirements, electrical requirements, and plumbing requirements. BOD cases were developed for different scenarios for water heater closet location including fully interior, on an exterior wall in the conditioned space, and outside of the conditioned space. The Statewide CASE Team reviewed available HPWH products on the market and adjusted the BOD as necessary to verify that the BOD represents the broader HPWH market.

The Statewide CASE Team leveraged RSMMeans to get water heater closet augmentation cost estimates and incorporated cost estimates gathered for the Individual HPWH Ventilation measure proposal (see Section 8.4.3) for water heater closet door ventilation grilles installation. Existing water heater closet space required is assumed to be 23”x39”x96” and new water heater closet space required by the electric ready code is 39”x39”x96”. Material and labor cost estimates for entire cost components were collected to calculate the incremental first and retrofit costs. The Statewide CASE Team did not consider structural costs because interviews with stakeholders involved in the retrofit design of individual HPWH suggested structural retrofit is not required.

Table 338: Incremental First and Incremental Retrofit Costs Per Dwelling Unit

Climate Zone	Incremental First Cost (2026 PV\$)	Incremental Retrofit Cost	Incremental Retrofit Cost (2026 PV\$)
1	\$188	-\$833	-\$461
2	\$228	-\$1,050	-\$581
3	\$213	-\$969	-\$536
4	\$229	-\$1,048	-\$580
5	\$228	-\$1,032	-\$571
6	\$192	-\$838	-\$464
7	\$193	-\$841	-\$466
8	\$190	-\$833	-\$461
9	\$189	-\$830	-\$460
10	\$191	-\$835	-\$463
11	\$193	-\$849	-\$470
12	\$198	-\$864	-\$478
13	\$196	-\$856	-\$474
14	\$187	-\$825	-\$457
15	\$187	-\$825	-\$457
16	\$192	-\$848	-\$469

9.4.4 Incremental Maintenance and Replacement Costs

Incremental maintenance cost is the incremental cost of replacing the equipment or parts of the equipment, as well as periodic maintenance required to keep the equipment operating relative to current practices over the 30-year period of analysis.

The Statewide CASE Team found that all equipment components related to the applicable improved individual electric ready methods have a usable life expectancy longer than the 30-year analysis period. Therefore, there are no Lifecycle Cost Hourly Factors to consider.

9.4.5 Cost-Effectiveness

This measure proposes a mandatory requirement. As such, a cost analysis is required to demonstrate that the measure is cost effective. Typically, the CEC establishes the procedures for calculating Cost-Effectiveness, which includes LSC savings from electricity and natural gas in the evaluation. For electric ready measures, there are no energy cost savings. As discussed in section 9.4.3, the Statewide CASE Team compared the 2026 present value of incremental first cost and the 2026 present value of incremental retrofit cost to determine Cost-Effectiveness. The electric ready measure is cost effective if the incremental net cost is less than or equal to “0”. The incremental first cost and incremental retrofit costs assuming a 20-year HPWH retrofit were included. Design costs were not included nor were the incremental costs of code compliance verification.

Cost savings between installing electric ready components at the time of construction compared to retrofit costs for a non-electric ready system is calculated as follows in Equation 4.

$$\text{Incremental Net Cost} = \text{Incremental First Cost} + \text{Incremental Retrofit Cost}$$

Equation 4: Incremental Net Cost

It’s important to acknowledge that cost savings associated with this proposal would only be realized if individual HPWHs are installed. At the same time, adoption of HPWH is increasingly driven by maturing technologies, local reach codes, utility programs, and energy conscious consumers. Whether or not the electric ready infrastructure would be used is an important concern, but the Statewide CASE Team believes that the Cost-Effectiveness analysis presented is the best way to understand the cost-benefit of the proposal given the trends of increasing adoption of individual HPWH. Finally, incremental first costs are based on data available today and can change over time as markets evolve and professionals become familiar with the individual electric ready water heating practices.

Results of the per-unit, cost-effectiveness analyses are presented in Table 339 for new construction. Standard practice in relationship to the existing individual electric ready water heating code requirements is to size the entire buildings electrical system for the future individual HPWH load, from the dwelling unit to the building main service. For this reason, only the water heater closet space augmentation and door ventilation were calculated to show Cost-Effectiveness. As seen in Table 339 below, individual electric ready was shown to be cost effective for the building prototypes and for all climate zones. The water heating closet size augmentation and door ventilation does not vary between building prototypes.

Table 339: Water Heating Closet Augmentation and Door Ventilation Costs Per Dwelling Unit

Climate Zone	Incremental First Cost	Incremental Retrofit Cost (2026 PV\$)	Incremental Net Cost (2026 PV\$)	Cost Effective?
1	\$188	-\$461	-\$273	Yes
2	\$228	-\$581	-\$353	Yes
3	\$213	-\$536	-\$324	Yes
4	\$229	-\$580	-\$351	Yes
5	\$228	-\$571	-\$343	Yes
6	\$192	-\$464	-\$272	Yes
7	\$193	-\$466	-\$273	Yes
8	\$190	-\$461	-\$271	Yes
9	\$189	-\$460	-\$271	Yes
10	\$191	-\$463	-\$272	Yes
11	\$193	-\$470	-\$277	Yes
12	\$198	-\$478	-\$281	Yes
13	\$196	-\$474	-\$277	Yes
14	\$187	-\$457	-\$269	Yes
15	\$187	-\$457	-\$269	Yes
16	\$192	-\$469	-\$278	Yes

- a. **Incremental First Cost (2026 PV\$):** Proposed Case at New Construction Cost – Base Case at New Construction Cost.
- b. **Incremental Retrofit Cost (2026 PV\$):** Base Case Retrofit Cost – Proposed Case Retrofit Cost (equal to \$0). The retrofit cost was multiplier by the present-day value formula assuming replacement at 20 years and three percent ($(1/(1+0.03))^{20} = 0.55368$)
- c. **Incremental Net Cost (2026 PV\$):** Incremental First Cost – Incremental Retrofit Cost.
- d. **Cost Effective:** “YES” when Total Incremental Cost is positive (Cost Savings) and “NO” when Total Incremental Cost is negative (NO Cost Savings)

9.5 Annual Statewide Impacts

The code change proposal would not modify the stringency of the existing California Energy Code, so the savings associated with this proposed change are minimal. Typically, the Statewide CASE Team presents a detailed analysis of statewide energy and cost savings associated with the proposed change in Section 9.5.1 of the CASE Report.

9.5.1 Statewide Energy and Energy Cost Savings

There is no energy or energy cost savings for this measure.

9.5.2 Statewide Greenhouse Gas (GHG) Emissions Reductions

There is no energy or energy cost savings for this measure.

9.5.3 Statewide Water Use Impacts

The proposed code change would not result in water savings.

9.5.4 Statewide Material Impacts

The proposed changes resulted in higher infrastructure requirement which includes addition of closet in-unit and grills for ventilation. Wood and drywall consumption would increase due to the addition of the closet. 2X4 wood stud with 16" on center spaced wooden studs are used for framing and 5/8" gypsum drywall is used as the material for the closet. Installation of grill resulted in increased usage of Steel. See Appendix D for more details.

Table 340: Annual Statewide Impacts on Material Use – Individual DHW Electric Ready

Material	Impact	Per-Unit Impacts (Pounds per Dwelling Area)	Annual Statewide Impacts (Pounds)
Steel	Increase	4.22	27,085
Wood	Increase	46.6	496,448
Gypsum	Increase	171.6	1,249,999
TOTAL	-	-	-

- First-year savings from all buildings completed statewide in 2026.
- Values in (red) represent increase in emissions.

9.5.5 Other Non-Energy Impacts

The proposed code change would not result in other non-energy impacts.

9.6 Addressing Energy Equity and Environmental Justice

The Statewide CASE Team assessed the potential impacts of the proposed measure on DIPs. See Section 2 for a summary of research methods and potentially impacted populations, as well as other general potential equity impacts (Meng, et al. 2007) (CALEPA 2022).

9.6.1 Potential Impacts

Positive effects of building electrification on DIPs, based on future adoption of heat pump water heating equipment as a result of the electric ready requirements include increased resiliency and health impacts, which are discussed in detail in section 2.2.2, with impacts on potentially impacted populations as described in section 2.2.1.

10. Central DHW Electric Ready

10.1 Measure Description

10.1.1 Proposed Code Change

This measure would include mandatory requirements for all new construction multifamily buildings constructed with gas or propane central water heating equipment to provide planning and infrastructure for future electric equipment. For the purposes of this measure, HPWH equipment includes the heat pump, storage tanks, and temperature maintenance tanks. This measure would require planning for the following electric ready components:

- Adequate physical space to accommodate the future HPWH equipment and required service clearance.
- Adequate planning to meet the future heat pump ventilation needs. This requirement can be met if the future heat pump is in an outdoor location.
- Installation of condensate drainage piping from the location of the future heat pump to an acceptable termination point, in accordance with the California Plumbing Code, to serve the future HPWH.
- Components of the building electrical system, but not the equipment main panel, dedicated equipment conduit, or dedicated equipment feeder or branch circuits serving the heat pump or temperature maintenance tanks. Electrical components that must be sized and installed to serve the future HPWH include the building main service conduit, the building main service switchboard (including pull section, main breaker, feeder breakers, and utility meter section), building transformers, intervening distribution boards, and intervening conduit and feeders as applicable to the project. Building Electrical Systems are custom designed for each project, and not all equipment listed here applies to every project.

Certain electrical equipment, such as the main service switchboard, might have multiple possible configurations. The Statewide CASE Team worked with an electrical design engineer to ensure the code language covers the different possible configurations. Refer to Appendix M for a more detailed explanation of each required electrical component and diagrams of common configurations.

The measure includes two pathways for the new construction to comply with the proposed requirements: the design team can meet the electric ready requirements using code prescribed sizing factors, or the design team can meet the electric ready requirements by planning for a specific product if sufficient documentation of the design is provided.

10.1.2 Justification and Background Information

10.1.2.1 Justification

With federal, state, local, and utility incentive programs, and a cultural drive towards reducing carbon emissions, the market for HPWH in California has increased significantly over the last few years. Water heating accounts for 40 percent of natural gas consumption in the residential sector, representing 7 percent of the state's total GHG emissions (E3 2019). Water heating energy use in multifamily buildings can account for 27 to 32 percent of total energy use based on 2015 Residential Energy Consumption Survey by U.S. EIA. In 2022, Governor Gavin Newsom announced plans to expand California's climate change programs through CARB and the CEC, with goals to install six million heat pumps (including HPWH) by 2030 (Newsom 2022).

As market adoption of HPWH continues to increase, it is important that California ensures building owners of new construction multifamily buildings with gas or propane water heating equipment are enabled to easily adopt HPWHs in future retrofits. This is especially important since HPWHs can be two to three times more energy efficient than a fossil-gas or electric-resistance water heating system.

This proposal is intended to make future retrofits from gas or propane central water heating equipment to central HPWH equipment more technically feasible and financially feasible. The proposal would achieve this goal by requiring new construction buildings with gas or propane central water heaters to also include electric ready infrastructure that is lower cost to install in new construction than during a retrofit. HPWH systems typically require more physical space, higher ventilation rates, more condensate drainage, and higher electrical capacity than equivalent gas or propane systems designed to meet the same hot water demands. This proposal brings central water heating equipment requirements into alignment with existing mandatory requirements for electric ready equipment in new construction multifamily buildings including individual water heating equipment (Title 24, Part 6, Section 160.4(a)), space heating equipment, cooktops, and clothes dryers (Title 24, Part 6, Section 160.9).

10.1.2.2 Background Information

The Statewide CASE Team pursued electric readiness requirements for central water heating systems for 2022 Title 24, Part 11 (CALGreen) (Statewide CASE Team 2021). While the period of CALGreen measure development was highly compressed, the Statewide CASE Team was able to vet some of the CALGreen electric ready measure with building industry representatives and develop code measures. Nonetheless, the CEC suggested that further stakeholder engagement and research would be necessary to adopt these measures in CALGreen. The Statewide CASE Team proposes to include this measure for 2025 Title 24, Part 6 with the intent to make future natural gas to electric retrofits feasible and financially feasible.

California utilities offer incentives for all-electric new construction in multifamily developments. These incentives have been available for the past three to four years. Most new construction multifamily buildings already have electric space conditioning, cooking, and clothes drying, and they are mostly all-electric except for water heating. With programs such as these encouraging the adoption of all-electric homes including heat pump technology, developers are receiving design assistance support to learn how to design buildings with code compliant heat pumps and standardize the design practice.

The 2022 Title 24, Part 6 code has existing requirements for gas uses such as space heating, cooking, clothes drying, and individual water heating in multifamily buildings. These requirements are included in Sections 160.9 and 160.4 respectively, and they require a dedicated circuit and panel space for the future electrical equipment. Standard electrical design practice is to size the entire building electrical system to meet the future load although this is not explicitly required in the code language.

As of December 2022, at least 70 jurisdictions across California have adopted electric readiness and all-electric construction reach codes during the 2019 code cycle (Velez and Borgeson 2022). Most of these jurisdictions require all-electric construction with no exception for water heating specifically. Some of these jurisdictions allow exceptions if a compliance pathway is not available under the 2022 Title 24, Part 6 code, and a builder is not able to meet the performance compliance standards using commercially available electric technology. In this case, the jurisdiction would allow gas equipment and might also require electric readiness similar to the requirements of Title 24, Part 6, Section 160.9. Most of these jurisdictions that provide some exception for gas equipment in new construction have electric ready requirements including a branch circuit with receptacle or junction box within five feet of the gas appliance, appropriately sized conduit, reserved panel space, adequately sized electrical supply equipment, and physical space.

10.1.3 Summary of Proposed Changes to Code Documents

The sections below summarize how the standards, Reference Appendices, ACM Reference Manuals, and compliance forms would be modified by the proposed change.¹⁰⁷ See Section 11 of this report for detailed proposed revisions to code language.

¹⁰⁷ Visit EnergyCodeAce.com for trainings, tools and resources to help people understand existing code requirements.

10.1.3.1 Specific Purpose and Necessity of Proposed Code Changes

Each proposed change to language in Title 24, Part 1 and Part 6 as well as the reference appendices to Part 6 are described below. See Section 11.2 of this report for marked-up code language.

Section: Section 160.9

Specific Purpose: The specific purpose is to update the existing mandatory requirements for electric ready buildings and add a mandatory requirement that central water heating systems must include installation and design features to facilitate future heat pump installation.

Necessity: This addition is necessary to ensure that building owners with gas or propane central water heating equipment can switch to energy efficient HPWHs in future retrofits.

10.1.3.2 Specific Purpose and Necessity of Changes to the Nonresidential and Multifamily ACM Reference Manual

The proposed code change would not modify the ACM Reference Manual

10.1.3.3 Summary of Changes to the Nonresidential and Multifamily Compliance Manual

Chapter 11.6.7 of the Nonresidential and Multifamily Compliance Manual would need to be revised. A new section needs to be added briefly describing the new mandatory electric ready requirements for central water heating. For consistency, the section should refer the reader to Chapter 11.10 for a detailed explanation of electric-ready requirements. The revisions to Chapter 11.10 should include updating Section 11.10.1 What's New in 2022 Energy Code. The revisions should also include updating tables in Section 11.10 to include summary information about the electric ready requirements, updating questions and answers, and adding diagrams for illustration of complex code topics.

10.1.3.4 Summary of Changes to Compliance Forms

The proposed code change would modify the compliance forms listed below. Examples of the revised forms are presented in Section 11.5.

- **2022-LMCC-PLB-E: Domestic Water Heating:** Adds a mandatory requirement question on if the design team has met the electric-ready requirements.
- **2022-NRCC-PLB-E: Domestic Water Heating:** Adds a mandatory requirement question on if the design team has met the electric-ready requirements.
- **2022-LMCI-PLB-E: Domestic Water Heating:** Adds a mandatory requirement question on if the construction team has met the electric-ready requirements.

- **2022-NRCI-PLB-E: Domestic Water Heating:** Adds a mandatory requirement question on if the construction team has met the electric-ready requirements.

10.1.4 Regulatory Context

10.1.4.1 Determination of Inconsistency or Incompatibility with Existing State Laws and Regulations

Title 24, Part 6 currently includes electric ready requirements for individual water heaters, space heating equipment, cooktops, and clothes dryers.

This proposal does not require changes to other building codes, nor would it conflict with other code requirements. The code language is written such that the design team is still responsible to ensure compliance of all electric ready infrastructure with the California Building Codes.

The Statewide CASE Team is not aware of incompatibility with any local laws. As described in Section 10.1.2.2 Background Information, many jurisdictions have adopted local all electric code requirements that exceed the proposed electric ready requirements. These local codes should have a positive impact on the proposal by increasing market awareness of what infrastructure is required for all electric heat pump water heating equipment.

10.1.4.2 Duplication or Conflicts with Federal Laws and Regulations

There are no relevant federal laws or regulations.

10.1.4.3 Difference From Existing Model Codes and Industry Standards

There are no relevant industry standards or model codes.

10.1.5 Compliance and Enforcement

When developing this proposal, the Statewide CASE Team considered methods to streamline the compliance and enforcement process and how negative impacts on market actors who are involved in the process could be mitigated or reduced. This section describes how to comply with the proposed code change. It also describes the compliance verification process. Appendix E: Discussion of Impacts of Compliance Process on Market Actors presents how the proposed changes could impact various market actors.

This measure is a mandatory measure for multifamily buildings and would affect several activities for all new construction projects with a central gas water heater. The compliance verification activities related to this measure that need to occur during each phase of the project are described below. The compliance and enforcement activities are especially important for this proposal since the electric ready infrastructure would

not affect the performance of the hot water system until the gas water heater is replaced with a HPWH.

- **Design Phase:**

- The plumbing engineer designs the plumbing systems including selecting the central gas water heater, which triggers the proposed requirements. Current activities include specifying the gas equipment and determining and coordinating physical space requirements, combustion air requirements, drainage piping locations, electrical requirements, and equipment weight to the rest of the design team. The proposal would require the plumbing engineer to also coordinate the new requirements for the future central HPWH including physical space, ventilation, condensate drainage, and electrical requirements. The plumbing engineer would also coordinate with the energy consultant and add content to the applicable NRCC or LMCC compliance form based on the project details (see Section 10.1.3.4 Summary of Changes to Compliance Forms).
- The mechanical engineer designs the HVAC systems in the building, including combustion air, outdoor air, and exhaust systems serving the central gas water heater (as applicable). Depending on the project, the HVAC engineer may be engaged to size ductwork and/or louvers to ensure adequate ventilation for the future central HPWH.
- The electrical engineer designs the electrical systems in the building, including for the central gas water heater. This proposal would change current practice by requiring the electrical engineer to plan for the future central HPWH electrical requirements when sizing the building electrical systems.

- **Permit Application Phase:**

- Plan checkers currently perform plan check reviews of the gas water heater systems and verify that the construction drawings meet code. The proposal would add new activities in this phase including requiring building officials to verify that the design team has met the code requirements for space, ventilation, condensate drainage, and adequate sizing of the building electrical system. The LMCC and NRCC forms would assist the building officials in understanding which projects need to meet the proposed requirements.

- **Construction Phase:**

- General contractors are responsible for construction of the building, including hiring specialized subcontractors as required. Based on the new proposal, the general contractor's responsibilities would now include coordinating with the construction team as needed to ensure the building is constructed adequately to meet the new requirements. The general contractor would also fill out the

- applicable NRCI or LMCI compliance form based on the project details (see Section 10.1.3.4 Summary of Changes to Compliance Forms).
- Currently, the plumbing subcontractor is typically responsible for installing the gas water heating system and any supporting systems such as the required condensate drainage piping, as specified by the plumbing engineer. The responsibilities of the plumbing subcontractor are not expected to change because of this proposal.
 - Currently, the mechanical subcontractor is responsible for ensuring combustion air requirements are met as specified by the mechanical engineer. Depending on how the design team plans to meet the proposed electric-ready ventilation requirements, the mechanical contractor may also have to install capped ductwork and/or louvers to serve the future central HPWH.
 - Currently, the electrical subcontractor is responsible for constructing the building electrical systems as specified by the electrical engineer. The responsibilities of the electrical subcontractor do not change significantly, although the proposal would generally result in larger/higher capacity electrical systems for a given building.
- **Inspection Phase:**
 - The inspector typically reviews the applicable NRCI or LMCI forms and verifies that the central gas water heater meets all applicable building codes, including the existing electric-ready requirements. This proposal would require the inspector to also verify that the following electric-ready provisions meet the new code requirements for physical space, ventilation, condensate drainage, and building electrical system sizing.

10.2 Market Analysis

10.2.1 Current Market Structure

The Statewide CASE Team performed a market analysis with the goals of identifying current technology availability, current product availability, and market trends. It then considered how the proposed standard may impact the market in general as well as individual market actors. Information was gathered about the incremental cost of complying with the proposed measure. Estimates of market size and measure applicability were identified through research and outreach with stakeholders including designers, design consultants, and a wide range of industry actors. In addition to conducting personalized outreach, the Statewide CASE Team discussed the current market structure and potential market barriers during public stakeholder meetings that the Statewide CASE Team held on February 17, 2023, and May 1, 2023. Add

presentation and notes to the bibliography and add an in-text citation to referenced material.

The main market actors include architects, building owners/developers, contractors, and design engineers:

- **Building Owners/Developers:** Owners and developers are the ultimate decision makers on the type of systems that go into their buildings. If the owners decide to install gas DHW system at the time of construction, they should be aware of the electric-ready requirements and the cost associated to meet the requirements.
- **Architects:** Architects design the buildings and plan for the spaces where gas water heaters and electric ready components are installed. Decisions made by architects on the size and location of mechanical/plumbing areas, as well as other aspects of building layout, can significantly impact the feasibility of electric readiness. For example, if the architect reserves insufficient space for the future HPWH, the cost of the future retrofit could be substantially higher. The architect's decisions also influence whether the future heat pump would be located outside, which impacts the cost of electric readiness, as well as technical details such as how the ventilation and structural requirements would be met.
- **Plumbing Engineers and Design Consultants:** Plumbing engineers (generally licensed mechanical engineers) are responsible for designing plumbing systems, including designing a HPWH system or a central gas DHW system with planning for future replacement with a central HPWH. Sometimes plumbing consultants would influence the design, but the plumbing engineer is ultimately responsible for the performance of the plumbing systems. These professionals would need to understand the specific electric ready requirements, design to meet the plumbing requirements, and coordinate the electrical, physical space, and ventilation requirements to other members of the design team.
- **Electrical Engineers:** Electrical engineers are responsible for designing electrical systems, including the building main service conduit, the building main service switchboard (including pull section, main breaker, feeder breakers, and utility meter section), building transformers, intervening distribution boards, and intervening conduit and feeders as applicable to the project. Electrical engineers would need to coordinate with the plumbing engineer to ensure the electric ready requirements are met.
- **Mechanical Engineers:** Mechanical engineers are responsible for the design of the mechanical systems, including performing sizing calculations to determine the size of ductwork and louvers serving the future HPWH (as applicable). The plumbing engineer would coordinate the airflow requirements to serve the future HPWH to the mechanical engineer, who would then coordinate the ductwork

and/or louver size requirements to the architect and structural engineer as applicable.

- **Structural Engineers:** Structural engineers are responsible for the building structure, including equipment support and ensuring that the buildings strength is not compromised by mechanical penetrations through the building envelope. For some projects, the mechanical engineer would coordinate duct and/or louver sizes to the structural engineer. The structural engineer would ensure the building has capacity to support these planned requirements. The Statewide CASE Team anticipates that, for most projects, the heat pump would be placed on the roof and the structural engineer would be minimally involved.
- **Contractors:** Central HPWH equipment is usually installed by the plumbing contractor, with some coordination by a general contractor and other trades. After installation, maintenance and repairs of central HPWH equipment may need to be performed by an HVAC contractor or other licensed professional to work with refrigerant-containing components.

10.2.2 Technical Feasibility and Market Availability

The Statewide CASE Team investigated the technical feasibility of electric ready requirements by understanding the installation approach and infrastructure difference between a central gas and central HPWH DHW system. As detailed in Section 7.2.2 of the Central HPWH measure, there is a wide range of HPWH system design approaches, which drive the space and infrastructure requirements. The Statewide CASE Team conducted research to understand the retrofit scopes and approaches when replacing a central gas DHW system with a central HPWH system and conducted interviews to identify the necessary components that must be addressed at the time of construction and installation of the gas system heater to facilitate retrofits to central HPWH systems in the future that are not cost prohibitive.

- The Statewide CASE Team interviewed one general contractor, two design consultants, and four designers to evaluate the central HPWH design practices, understand the scope and approaches used to retrofit gas systems to HPWH systems, and identify the components that would be high cost and/or high impact at the time of the electrification retrofit.
- The Statewide CASE Team interviewed a structural engineer to understand how technical feasibility might be impacted if structural planning is not explicitly required by the energy code.
- The Statewide CASE Team performed plans review of gas central water heating and HPWH projects.

To quantitatively evaluate the impacts of retrofitting the gas water heating systems to HPWH, the Statewide CASE Team worked with professional plumbing engineers and

electrical engineers to develop a BOD (see Table 526 and Table 528 through Table 530) for the four multifamily building prototypes. The BOD includes gas and HPWH specifications, space, electrical, weight, and plumbing requirements when replacing a central gas DHW system with solar thermal preheat system to a central HPWH system. The plumbing engineers determined the water heating demand for each of the four building prototypes by using plumbing design principles and selected gas and HPWH systems that would satisfy the calculated demand. The HPWH BOD is based on a single pass CO₂ system without dedicated backup resistance heating. Since CO₂ heat pump systems can operate in every CA Climate Zone without dedicated backup electric resistance heating, this design concept reduces the electrical capacity required. It's important to note that the BOD was not developed with redundancy in mind, although there is some redundancy due to the electric resistance element in the temperature maintenance tanks and due to the number of HP.

In order to capture a wide range of outcomes, the BOD includes two HPWH sizing strategies. One sizing strategy (Standard Recovery) targets 16 hours of heat pump recovery operation per day, while the other (High Recovery) targets 13-13.5 hours of heat pump operation per day. Although the plumbing engineer the Statewide CASE Team worked with typically sizes for the Standard Recovery, the Statewide CASE Team's analysis is based on the intersection of the space and infrastructure requirements for both, which provides significant advantages including:

1. There is variability in design practice, and this method offers more flexibility to the future engineer, and
2. The high recovery design can meet the loads in colder climate zones where the HP performance could degrade due to low outdoor temperatures, such as Climate Zone 16, and
3. It is not practical to review every possible design configuration of current and future HPWH, especially since the market is rapidly evolving, but developing the proposal based on a range of designs results in a high level of confidence that the reserved space and infrastructure would be adequate for a future HPWH system (and likely several design configurations)

The Standard recovery design results in, on average, lower heat pump rated capacities and higher storage volumes than the high recovery designs.

Once the various prototype plumbing designs were completed, the Statewide CASE Team analyzed the designs and developed electric ready HPWH sizing factors that relate the HPWH space and infrastructure requirements to the fuel gas input of the fuel gas water heater. The final sizing factors are based on the intersection of the standard recovery and high recovery HPWH space and infrastructure requirements. After developing sizing factors, the Statewide CASE Team compared the results of using the

sizing factors to other existing CO2 systems. For the low-rise garden style prototype (<200 MBH gas input), the Statewide CASE Team is only aware of one CO2 split system HP at the size required, which is the equipment specified in the BOD, so the Statewide CASE Team did not perform the analysis for the <200 MBH gas input rule set. For the >200 MBH rule set, the Statewide CASE Team reviewed in-depth product data for:

1. Electrical Requirements: 5 CO2 heat pumps by 2 manufacturers (not including the BOD heat pumps) to compare the basis of design to the market of available CO2 HPWH.
2. Evaporator air flow and space required: 3 CO2 heat pumps by 1 manufacturer (not including the BOD heat pumps)

For the electrical requirements, 3 of the products analyzed require more power per output capacity, whereas 2 of the products analyzed require less power per output capacity. For air flow requirements, 2 of the products analyzed require more air flow per output capacity, whereas 1 of the products analyzed requires less air flow per output capacity. For space requirements, the BOD space required is smaller than the 3 other products analyzed. The Statewide CASE Team also analyzed plan sets for real world electric ready water heating projects to inform development of the prescriptive sizing factors.

The proposed code requirements are based on sizing factors which were developed based on this research including the BOD standard and high recovery designs developed by the Statewide CASE Team. The code requirements are structured to allow an engineered design of the future HPWH or allow the use of sizing factors, which are based on the size of the originally installed gas central water heating system, to determine space and infrastructure requirements for the future HPWH. The Statewide CASE Team found that using two rule sets is advantageous as compared to using only one ruleset, and the sizing factors are composed of two rule sets, one for gas water heater capacity less than 200 MBH and one for gas water heater capacity greater than or equal to 200 MBH.

The following sections describe the critical components that are necessary for electric readiness, and how the final code requirements were developed. The sizing factors can be found in the proposed code language.

10.2.2.1 Electrical Requirements

Any future retrofit from central gas water heater to central HPWH would put greater demand on the buildings electrical system, including all upstream electrical components. The Statewide CASE Team identified that the most significant technical challenges for a future retrofit to central HPWH were upstream of the equipment main panel. Furthermore, the exact electrical needs at the equipment level depend heavily on the HPWH design and configuration which are details that might not be known at the time of new construction, considering that the retrofit may happen up to 20 years after

new construction. For this reason, although the Statewide CASE Team did calculate and consider the cost of conduit, feeder, and main panel serving the central HPWH. The following upstream components are more challenging and costly to retrofit, and more necessary to electric readiness: building main service conduit, the building main service switchboard (including pull section, main breaker, feeder breakers, and utility meter section), building transformers, intervening distribution boards, and intervening conduit and feeders. Conveniently, focusing on these components also allows more flexibility to the future designer. See Appendix K for a detailed description of the building electrical system, including schematics.

In order to develop the prescriptive sizing factors, the Statewide CASE Team quantitatively evaluated the electrical power requirements in kVA needed to serve central HPWH systems based on the BOD design for the four prototype buildings. The Statewide CASE Team correlated the electrical power required to serve the retrofitted HPWHs with respect to the existing gas water heating system capacity. The Statewide CASE Team also compared the electrical requirement of the HPWH specified in the BOD design to a wide range of HPWH product to evaluate the range of the electrical impacts for code development.

10.2.2.2 Space Requirements and Equipment Location

HPWHs use electricity to produce hot water by transferring heat energy from one source, typically air, to potable water. Therefore, heat pumps need access to outdoor air or to a high volume of ventilation air as a heat source. Gas central water heating systems tend to have a smaller overall footprint than HPWH systems and require much less air for combustion, which means that the existing mechanical space is not typically adequate for the future HPWH. Fortunately, the Statewide CASE Team learned from stakeholders that HPWH are often retrofit with the tanks at the original mechanical room and the heat pumps outside.

Although there are many possible locations for central HPWH equipment, the Statewide CASE Team determined that outdoor installation is likely the most technically feasible and the BOD is based on outdoor installation of each HP (See Appendix J for the BOD). The Statewide CASE Team performed plans review of 10 new construction HPWH projects and found that 4 of 10 projects located the central heat pump outside the building, 4 of 10 projects located the central heat pump in the parking garage, and only 2 of 10 projects located the central heat pump inside (one with ducting to exterior, one without ducting to the exterior). Based on interviews conducted with two design consultants and four designers, 4 of six stakeholders recommended that locating the heat pump outside is appropriate and common practice for retrofit scenarios. Two of six stakeholders recommended that the tanks could go in the existing mechanical room.

The Statewide CASE Team found that the physical space required for the HPWH storage tanks, temperature maintenance tanks, and other accessory components is less than the space required for the existing gas equipment serving each prototype building. This means that the size of the mechanical room does not need to be larger to accommodate the future HPWH which is a major benefit. Other common locations for the HP include:

- **Outside:** The most straightforward location for central HPWH equipment is outside, either on the roof or on the ground. All standalone HPWH units are rated for outdoor use. For ground-level installation, designers need to ensure the discharge air from the heat pump (which would be noticeably cold), is not directed at locations where people are likely to spend significant time, particularly in the winter. Equipment located outside or on a roof may present noise and/or vibration control concerns. As such, designers would need to consult manufacturer sound decibel ratings and implement appropriate noise/vibration control measures, particularly if equipment is located adjacent to living spaces.
- **Parking Garage:** Ground floor or underground garages are another common location for central HPWH equipment. A covered, naturally ventilated garage is an ideal location for a HPWH, since it is effectively outside with respect to air circulation, but it is protected from sun and rain. Fan-exhausted garages can also serve as locations for central HPWH; some designers have connected the heat pumps to the garage exhaust systems or used the heat pumps as the exhaust system. In colder climates, locating a HPWH in a garage, which would generally be slightly warmer than the outside air in the winter, can help raise the average air temperature seen by the heat pump and improve system efficiency (Ecotope 2009).
- **Inside with Ducting:** In some circumstances, central HPWH equipment may be located inside or in areas with insufficient natural air circulation. These cases require ducted units or adequate wall louvers. Manufacturers typically recommend ducting the (cold) exhaust air from the heat pumps out of the space and allowing makeup air into the room via passive louvers, though both air streams can generally be ducted if necessary. Designers must ensure louvers are large enough and must design the ducting to not exceed the static pressure limits of the heat pump fans.

The Statewide CASE Team characterized space requirement for central HPWH systems based on the BOD design for the four prototype buildings. The Statewide CASE Team evaluated total area needed for heat pump equipment and storage tanks, including clearance access and air flow access for the HP, with respect to the existing gas system heating capacity. The Statewide CASE Team also developed a minimum linear dimension for the future HPWH. Finally, the Statewide CASE Team compared the

space requirements of the HPWH specified in the BOD design to a wide range of HPWH product to evaluate the range of the space impacts for code development.

10.2.2.3 Ventilation Requirements

HPWHs use electricity to produce hot water by transferring heat energy from one source, typically air, to potable water. Therefore, heat pumps need access to outdoor air or to a high volume of ventilation air as a heat source. As stated in section 10.2.2.2 Space Requirements and Equipment Location, the Statewide CASE Team determined that the most technically feasible location for the central heat pump is outdoors with adequate clearance; When the reserve space for the heat pump is located outdoors, no additional ventilation planning is required to be electric ready. The Statewide CASE Team did develop ventilations sizing factors with respect to the existing gas system heating capacity in case the design team prefers to locate the heat pump inside and require ventilation to the outside. Finally, the Statewide CASE Team compared the ventilation requirements of the HPWH specified in the BOD design to a wide range of HPWH product to evaluate the range of the space impacts for code development.

10.2.2.4 Plumbing

There are several differences in piping for central HPWH vs. central gas water heaters including different equipment locations, different plant piping, and differences in condensate generation. The Statewide CASE Team proposal only proposes requiring planning for condensate waste from the future HP location since it is low cost at new construction but can be expensive to retrofit.

The proposed code would require planning for condensate drainage, based on stakeholder feedback that condensate drainage is critical for electric readiness and low cost at new construction. The Statewide CASE Team anticipates that HPWH systems are typically located outside with sufficient options for condensate drainage such as roof drains or other drains serving HVAC equipment. Additionally, if the HPWH unit is in the mechanical room, there are typically adequately sized condensate drainage options serving the existing gas system. In order to develop the prescriptive sizing factors, the Statewide CASE Team quantitatively evaluated the nominal capacity of each HPWH systems based on the BOD design for the four prototype buildings. The Statewide CASE Team correlated the nominal capacity required to serve the retrofitted HPWHs with respect to the existing gas water heating system capacity. The plumbing engineer would then reference the CPC, which includes a method for sizing of condensate drainage according to capacity, to size the condensate drainage piping.

The Statewide CASE Team considered requiring reserved space for piping routing from the HPWH tanks to the HPWH HP but decided against it based on conversations with various stakeholders. The most significant barrier to developing a requirement is that the future equipment quantity and plant piping requirements are unknown. A concern

the Statewide CASE Team heard is that the location of the future HP may not be where the original design team anticipated, due in part to rapid changes in the technology itself. The Statewide CASE Team spoke to a plumbing contractor who suggested that it is typically feasible to retrofit piping from the mechanical room to the roof or outdoors, although there are some buildings where this is more difficult. This plumbing contractor also pointed out that reserve space for future piping would typically be an enclosed chase and would need to be accessed and partially demolished to add pipes later which results in less savings potential. Due to these considerations, the Statewide CASE Team did not pursue this requirement further.

10.2.2.5 Structural

Due to the significant weight of water heating systems, especially for larger buildings, the Statewide CASE Team considered whether to add specific requirements for structural planning. Four out of five stakeholder plumbing designers and plumbing design consultants the Statewide CASE Team interviewed mentioned that the weight of the HPWH system is significant and should ideally be planned for at new construction. Additionally, when neglecting the solar preheat tanks associated with gas systems, the HPWH system tank sizes are heavier than gas systems.

The Statewide CASE Team interviewed a structural engineer to discuss the structural impacts of adding a HPWH system to an existing building to determine if structural requirements should be added to the proposal. Structural engineers are responsible for the design of the building structure and are therefore most qualified market actors to speak to the technical feasibility of retrofits and design details that affect retrofit cost. The Statewide CASE Team reviewed the BOD (see Appendix J) for the gas and HPWH systems for the four prototype buildings with the structural engineer, including weight, equipment location, and approximate footprint of the system. The Statewide CASE Team presented the gas system weights without the solar preheat tanks to get a worst-case estimate of the structural impacts of retrofitting to HPWH. Based on the interview with the structural engineer interviewed, the Statewide CASE Team determined that:

1. If space is reserved for the future HP outside (such as on the roof), the structural engineer on the project would likely add adequate strength for the future HP as standard practice even if there is not an explicit code requirement to do so, and
2. If the structural engineer does not add strength for the future heat pump at the time of new construction, there are technically feasible methods that are not cost-prohibitive to distribute the load at time of retrofit so that the HP can be supported by the existing structure.
3. The strength on the first floor can typically accommodate the weight increase associated with retrofitting from a gas water heating system to tanks serving the HP.

Based on the available evidence, the Statewide CASE Team did not add a requirement for structural planning to the proposal. Structural Engineers should consider the benefits of adding structural capacity for the future HPWH given the low cost to do so.

10.2.3 Market Impacts and Economic Assessments

10.2.3.1 Impact on Builders

Builders of residential and commercial structures are directly impacted by many of the measures proposed by the Statewide CASE Team for the 2025 code cycle. It is within the normal practices of these businesses to adjust their building practices to changes in building codes. When necessary, builders engage in continuing education and training to remain compliant with changes to design practices and building codes.

California’s construction industry comprises approximately 93,000 business establishments and 943,000 employees (see Table 341). For 2022, total estimated payroll would be about \$78 billion. Nearly 72,000 of these business establishments and 473,000 employees are engaged in the residential building sector, while another 17,600 establishments and 369,000 employees focus on the commercial sector. The remainder of establishments and employees work in industrial, utilities, infrastructure, and other heavy construction roles (the industrial sector).

Table 341: California Construction Industry, Establishments, Employment, and Payroll in 2022 (Estimated)

Building Type	Construction Sectors	Establishments	Employment	Annual Payroll (Billions \$)
Residential	All	71,889	472,974	31.2
Residential	Building Construction Contractors	27,948	130,580	9.8
Residential	Foundation, Structure, & Building Exterior	7,891	83,575	5.0
Residential	Building Equipment Contractors	18,108	125,559	8.5
Residential	Building Finishing Contractors	17,942	133,260	8.0
Commercial	All	17,621	368,810	35.0
Commercial	Building Construction Contractors	4,919	83,028	9.0
Commercial	Foundation, Structure, & Building Exterior	2,194	59,110	5.0
Commercial	Building Equipment Contractors	6,039	139,442	13.5
Commercial	Building Finishing Contractors	4,469	87,230	7.4

Building Type	Construction Sectors	Establishments	Employment	Annual Payroll (Billions \$)
Industrial, Utilities, Infrastructure, & Other (Industrial+)	All	4,206	101,002	11.4
Industrial+	Building Construction	288	3,995	0.4
Industrial+	Utility System Construction	1,761	50,126	5.5
Industrial+	Land Subdivision	907	6,550	1.0
Industrial+	Highway, Street, and Bridge Construction	799	28,726	3.1
Industrial+	Other Heavy Construction	451	11,605	1.4

Source: (State of California n.d.)

The proposed change to Central HPWH Electric Ready would likely affect residential builders but would not impact firms that focus on construction and retrofit of industrial buildings, utility systems, public infrastructure, or other heavy construction. The effects on the residential and commercial building industry would not be felt by all firms and workers, but rather would be concentrated in specific industry subsectors. Table 342 shows the residential building subsectors the Statewide CASE Team expects to be impacted by the changes proposed in this report. The additional space required for electric ready as well as the additional electrical infrastructure would significantly influence the work required in multifamily buildings. The Statewide CASE Team’s estimates of the magnitude of these impacts are shown in Section 10.2.4 Economic Impacts.

Table 342: Specific Subsectors of the California Residential Building Industry by Subsector in 2022 (Estimated)

Residential Building Subsector	Establishments	Employment	Annual Payroll (Billions \$)
New multifamily general contractors	421	6,344	0.7
New housing for-sale builders	189	3,969	0.5
Residential Electrical Contractors	7,857	48,366	3.3
Residential plumbing and HVAC contractors	9,852	75,404	5.1

Source: (State of California n.d.)

10.2.3.2 Impact on Building Designers and Energy Consultants

Adjusting design practices to comply with changing building codes is within the normal practices of building designers. Building codes (including Title 24, Part 6) are typically updated on a three-year revision cycle and building designers and energy consultants

engage in continuing education and training in order to remain compliant with changes to design practices and building codes.

For this proposal, newly constructed buildings would require more space for the installation of a future HPWH. Architects and plumbing engineers would likely require some training on the space requirements as well as ventilation requirements for the HPWH. Architects could also benefit from a professional association that might incorporate a townhall discussion as how to make optimum use of the reduced space they have for the dwelling units they design. HVAC designers would need to learn the ventilation requirements, and General Contractors as well could potentially benefit from some training as to how to deal with bidding the additional materials necessary.

Businesses that focus on residential, commercial, institutional, and industrial building design are contained within the Architectural Services sector (NAICO 541310). Table 343 shows the number of establishments, employment, and total annual payroll for Building Architectural Services. The proposed code changes would potentially impact all firms within the Architectural Services sector. The Statewide CASE Team anticipates the impacts for central HPWH electric ready to affect firms that focus on multifamily construction.

There is not a NAICS¹⁰⁸ code specific to energy consultants. Instead, businesses that focus on consulting related to building energy efficiency are contained in the Building Inspection Services sector (NAICS 541350), which is comprised of firms primarily engaged in the physical inspection of residential and nonresidential buildings.¹⁰⁹ It is not possible to determine which business establishments within the Building Inspection Services sector are focused on energy efficiency consulting. The information shown in Table 343 provides an upper bound indication of the size of this sector in California.

¹⁰⁸ NAICS is the standard used by federal statistical agencies in classifying business establishments for the purpose of collecting, analyzing, and publishing statistical data related to the U.S. business economy. NAICS was developed jointly by the U.S. Economic Classification Policy Committee (ECPC), Statistics Canada, and Mexico's Instituto Nacional de Estadística y Geografía, to allow for a high level of comparability in business statistics among the North American countries. NAICS replaced the Standard Industrial Classification (SIC) system in 1997.

¹⁰⁹ Establishments in this sector include businesses primarily engaged in evaluating a building's structure and component systems and includes energy efficiency inspection services and home inspection services. This sector does not include establishments primarily engaged in providing inspections for pests, hazardous wastes or other environmental contaminants, nor does it include state and local government entities that focus on building or energy code compliance/enforcement of building codes and regulations.

Table 343: California Building Designer and Energy Consultant Sectors in 2022 (Estimated)

Sector	Establishments	Employment	Annual Payroll (Millions \$)
Architectural Services ^a	4,134	31,478	3,623.3
Building Inspection Services ^b	1,035	3,567	280.7

Source: (State of California n.d.)

- c. Architectural Services (NAICS 541310) comprises private-sector establishments primarily engaged in planning and designing residential, institutional, leisure, commercial, and industrial buildings and structures.
- d. Building Inspection Services (NAICS 541350) comprises private-sector establishments primarily engaged in providing building (residential & nonresidential) inspection services encompassing all aspects of the building structure and component systems, including energy efficiency inspection services.

10.2.3.3 Impact on Occupational Safety and Health

The proposed code change does not alter any existing federal, state, or local regulations pertaining to safety and health, including rules enforced by the California DOSH. All existing health and safety rules would remain in place. Complying with the proposed code change is not anticipated to have adverse impacts on the safety or health of occupants or those involved with the construction, commissioning, and maintenance of the building.

10.2.3.4 Impact on Building Owners and Occupants Including Homeowners and Potential First-Time Homeowners

Residential Buildings

According to data from the U.S. Census ACS, there were more than 14.5 million housing units in California in 2021 and nearly 13.3 million were occupied (see Table 344). Most housing units (nearly 9.42 million) were single family homes (either detached or attached), approximately 2 million homes were in buildings containing two to nine units, and 2.5 million homes were in multifamily buildings containing 10 or more units. The California Department of Revenue estimated that building permits for 67,300 single family and 54,900 multifamily homes would be issued in 2022, up from 66,000 single family and 53,500 multifamily permits issued in 2021.

Table 344: California Housing Characteristics in 2021^a

Housing Measure	Estimate
Total housing units	14,512,281
Occupied housing units	13,291,541
Vacant housing units	1,220,740
Homeowner vacancy rate	0.7%
Rental vacancy rate	4.3%
Number of 1-unit, detached structures	8,388,099
Number of 1-unit, attached structures	1,030,372
Number of 2-unit structures	348,295
Number of 3- or 4-unit structures	783,663
Number of 5- to 9-unit structures	856,225
Number of 10- to 19-unit structures	740,126
Number of 20+ unit structures	1,828,547
Mobile home, RV, etc.	522,442

Sources: (United States Census Bureau n.d.), (Federal Reserve Economic Data (FRED) n.d.)

a. Total housing units as reported for 2021; all other housing measures estimated based on historical relationships.

Table 345 shows the distribution of California homes by vintage. About 15 percent of California homes were built in 2000 or later, and another 11 percent built between 1990 and 1999. The majority of California’s existing housing stock (8.5 million homes – 59 percent of the total) were built between 1950 and 1989, a period of rapid population and economic growth in California. Finally, about 2.1 million homes in California were built before 1950. According to Kenney et al, 2019, more than half of California’s existing multifamily buildings (those with five or more units) were constructed before 1978 when there was no California Energy Code (Kenney 2019).

Table 345: Distribution of California Housing by Vintage in 2021 (Estimated)

Home Vintage	Units	Percent	Cumulative Percent
Built 2014 or later	348,296	2.4	2.4
Built 2010 to 2013	261,221	1.8	4.2
Built 2000 to 2009	1,581,839	10.9	15.1
Built 1990 to 1999	1,596,351	11.0	26.1
Built 1980 to 1989	2,191,354	15.1	41.2
Built 1970 to 1979	2,539,649	17.5	58.7
Built 1960 to 1969	1,915,621	13.2	71.9
Built 1950 to 1959	1,930,133	13.3	85.2
Built 1940 to 1949	841,712	5.8	91.0
Built 1939 or earlier	1,306,105	9.0	100.0
Total housing units	14,512,281	100.0	–

Sources: (United States Census Bureau n.d.), (Federal Reserve Economic Data (FRED) n.d.)

Table 346 shows the distribution of owner- and renter-occupied housing by household income. Overall, about 55 percent of California housing is owner-occupied and the rate of owner-occupancy generally increases with household income. The owner-occupancy rate for households with an income below \$50,000 is only 37 percent, whereas the owner occupancy rate is 71 percent for households earning \$100,000 or more.

Table 346: Owner- and Renter-Occupied Housing Units in California by Income in 2021 (Estimated)

Household Income	Total	Owner Occupied	Renter Occupied
Less than \$5,000	353,493	113,315	240,178
\$5,000 to \$9,999	254,304	74,939	179,366
\$10,000 to \$14,999	495,287	134,633	360,654
\$15,000 to \$19,999	412,498	144,064	268,435
\$20,000 to \$24,999	467,694	169,431	298,264
\$25,000 to \$34,999	906,996	355,968	551,028
\$35,000 to \$49,999	1,319,892	560,453	759,438
\$50,000 to \$74,999	2,036,560	990,769	1,045,791
\$75,000 to \$99,999	1,662,032	920,607	741,425
\$100,000 to \$149,999	2,307,889	1,490,247	817,642
\$150,000 or more	3,074,895	2,337,651	737,244
Total Housing Units	13,291,541	7,292,076	5,999,465

Source: (United States Census Bureau n.d.), (Federal Reserve Economic Data (FRED) n.d.)

Understanding the distribution of California residents by home type, home vintage, and household income is critical for developing meaningful estimates of the economic impacts associated with proposed code changes affecting residents. Many proposed code changes specifically target single family or multifamily residences, so the counts of housing units by building type shown in Table 346 provides the information necessary to quantify the magnitude of potential impacts. Likewise, impacts may differ for owners and renters, by home vintage, and by household income, information provided in Table 345 and Table 346.

Estimating Impacts

The Statewide CASE Team estimates that the proposed change to Title 24, Part 6 would increase not construction cost which would result in an NPV of \$0. Because this measure would add no cost to construction and the NPV is \$0 this measure is considered to be cost effective.

10.2.3.5 Impact on Building Component Retailers (Including Manufacturers and Distributors)

The Statewide CASE Team anticipates the proposed change would have no material impact on California component retailers.

10.2.3.6 Impact on Building Inspectors

Table 347 shows employment and payroll information for state and local government agencies in which many inspectors of residential and commercial buildings are employed. Building inspectors participate in continuing education and training to stay current on all aspects of building regulations, including energy efficiency. Therefore, the Statewide CASE Team anticipates the proposed change would have no impact on employment of building inspectors or the scope of their role conducting energy efficiency inspections.

Table 347: Employment in California State and Government Agencies with Building Inspectors in 2022 (Estimated)

Sector	Govt.	Establishments	Employment	Annual Payroll (Million \$)
Administration of Housing Programs^a	State	18	265	29.0
	Local	38	3,060	248.6
Urban and Rural Development Admin^b	State	38	764	71.3
	Local	52	2,481	211.5

Source: (State of California, Employment Development Department n.d.)

- a. Administration of Housing Programs (NAICS 925110) comprises government establishments primarily engaged in the administration and planning of housing programs, including building codes and standards, housing authorities, and housing programs, planning, and development.
- b. Urban and Rural Development Administration (NAICS 925120) comprises government establishments primarily engaged in the administration and planning of the development of urban and rural areas. Included in this industry are government zoning boards and commissions.

10.2.3.7 Impact on Statewide Employment

As described in Sections 10.2.3.1 through 10.2.3.6, the Statewide CASE Team does not anticipate significant employment or financial impacts to any sector of the California economy. This is not to say that the proposed change would not have modest impacts on employment in California. In Section 10.2.4, the Statewide CASE Team estimated the proposed change in central HPWH electric ready would affect statewide employment and economic output directly and indirectly through its impact on builders, designers and energy consultants, and building inspectors. In addition, the Statewide CASE Team estimated how energy savings associated with the proposed change in central HPWH electric would lead to modest ongoing financial savings for California residents, which would then be available for other economic activities.

10.2.4 Economic Impacts

For the 2025 code cycle, the Statewide CASE Team used the IMPLAN model software¹¹⁰, along with economic information from published sources and professional judgement, to develop estimates of the economic impacts associated with each of the proposed code changes. Conceptually, IMPLAN estimates jobs created as a function of incoming cash flow in different sectors of the economy, due to implementing a code or a standard. The jobs created are typically categorized into direct, indirect, and induced employment. For example, cash flow into a manufacturing plant captures direct employment (jobs created in the manufacturing plant), indirect employment (jobs created in the sectors that provide raw materials to the manufacturing plant), and induced employment (jobs created in the larger economy due to purchasing habits of people newly employed in the manufacturing plant). Eventually, IMPLAN computes the total number of jobs created due to a code. The assumptions of IMPLAN include constant returns to scale, fixed input structure, industry homogeneity, no supply constraints, fixed technology, and constant byproduct coefficients. The model is also static in nature and is a simplification of how jobs are created in the macro-economy.

The economic impacts developed for this report are only estimates and are based on limited and to some extent speculative information. The IMPLAN model provides a relatively simple representation of the California economy and, though the Statewide CASE Team is confident that the direction and approximate magnitude of the estimated economic impacts are reasonable, it is important to understand that the IMPLAN model is a simplification of extremely complex actions and interactions of individuals, businesses, and other organizations as they respond to changes in energy efficiency codes. In all aspect of this economic analysis, the Statewide CASE Team relies on conservative assumptions regarding the likely economic benefits associated with the proposed code change. By following this approach, the economic impacts presented below represent lower bound estimates of the actual benefits associated with this proposed code change.

Adoption of this code change proposal would result in relatively modest economic impacts through the additional direct spending those in the residential building and remodeling industry as well as indirectly as residents spend all or some of the money saved through lower utility bills on other economic activities.¹¹¹ There may also be some nonresidential customers that are impacted by this proposed code change; however, the Statewide CASE Team does not anticipate such impacts to be materially important to the building owner and would have measurable economic impacts.

¹¹⁰ IMPLAN employs economic data and advanced economic impact modeling to estimate economic impacts for interventions like changes to the California Title 24, Part 6 code. For more information on the IMPLAN modeling process, see www.IMPLAN.com.

¹¹¹ For example, for the lowest income group, the Statewide CASE Team assumes 100 percent of money saved through lower energy bills would be spent, while for the highest income group, the Statewide CASE Team assumes only 64 percent of additional income would be spent.

Table 348: Estimated Impact that Adoption of the Proposed Measure would have on the California Residential Construction Sector

Type of Economic Impact	Employment (Jobs)	Labor Income (Million)	Total Value Added (Million)	Output (Million)
Direct Effects (Additional spending by Residential Builders)	0.0	\$0	\$0	\$0
Indirect Effect (Additional spending by firms supporting Residential Builders)	0.0	\$0	\$0	\$0
Induced Effect (Spending by employees of firms experiencing “direct” or “indirect” effects)	0.0	\$0	\$0	\$0
Total Economic Impacts	0.0	\$0	\$0	\$0

Source: Statewide CASE Team analysis of data from the IMPLAN modeling software.¹¹²

Table 349: Estimated Impact that Adoption of the Proposed Measure would have on the California Building Designers and Energy Consultants Sectors

Type of Economic Impact	Employment (Jobs)	Labor Income (Million)	Total Value Added (Million)	Output (Million)
Direct Effects (Additional spending by Building Designers & Energy Consultants)	1.1	\$118,296	\$117,112	\$185,107
Indirect Effect (Additional spending by firms supporting Bldg. Designers & Energy Consultants)	0.4	\$35,223	\$48,953	\$78,804
Induced Effect (Spending by employees of firms experiencing “direct” or “indirect” effects)	0.6	\$44,144	\$79,052	\$125,823
Total Economic Impacts	2.2	\$197,663	\$245,117	\$389,733

Source: Statewide CASE Team analysis of data from the IMPLAN modeling software.

Table 350: Estimated Impact that Adoption of the Proposed Measure would have on California Building Inspectors

Type of Economic Impact	Employment (Jobs)	Labor Income (Million)	Total Value Added (Million)	Output (Million)
Direct Effects (Additional spending by Building Inspectors)	0.1	\$7,162	\$8,493	\$10,321
Indirect Effect (Additional spending by firms supporting Building Inspectors)	0.0	\$663	\$1,033	\$1,799
Induced Effect (Spending by employees of Building Inspection Bureaus and Departments)	0.0	\$2,253	\$4,035	\$6,423
Total Economic Impacts	0.1	\$10,077	\$13,561	\$18,542

Source: Statewide CASE Team analysis of data from the IMPLAN modeling software.

¹¹² IMPLAN® model, 2020 Data, IMPLAN Group LLC, IMPLAN System (data and software), 16905 Northcross Dr., Suite 120, Huntersville, NC 28078 www.IMPLAN.com

10.2.4.1 Creation or Elimination of Jobs

The Statewide CASE Team does not anticipate that the measures proposed for the 2025 code cycle regulation would lead to the creation of new *types* of jobs or the elimination of *existing* types of jobs. In other words, the Statewide CASE Team’s proposed change would not result in economic disruption to any sector of the California economy. Rather, the estimates of economic impacts discussed in Section 10.2.4 would lead to modest changes in employment of existing jobs.

10.2.4.2 Creation or Elimination of Businesses in California

As stated in Section 10.2.4.1, the Statewide CASE Team’s proposed change would not result in economic disruption to any sector of the California economy. The proposed change represents a modest change to building and electrical design, which would not excessively burden or competitively disadvantage California businesses—nor would it necessarily lead to a competitive advantage for California businesses. Therefore, the Statewide CASE Team does not foresee any new businesses being created, nor does the Statewide CASE Team think any existing businesses would be eliminated due to the proposed code changes.

10.2.4.3 Competitive Advantages or Disadvantages for Businesses in California

The proposed code changes would apply to all businesses incorporated in California, regardless of whether the business is located inside or outside of the state.¹¹³ Therefore, the Statewide CASE Team does not anticipate that these measures proposed for the 2025 code cycle regulation would have an adverse effect on the competitiveness of California businesses. Likewise, the Statewide CASE Team does not anticipate businesses located outside of California would be advantaged or disadvantaged.

10.2.4.4 Increase or Decrease of Investments in the State of California

The Statewide CASE Team analyzed national data on corporate profits and capital investment by businesses that expand a firm’s capital stock (referred to as net private domestic investment, or NPDI).¹¹⁴ As Table 351 shows, between 2017 and 2021, NPDI as a percentage of corporate profits ranged from a low of 18 percent in 2020 due to the worldwide economic slowdowns associated with the COVID 19 pandemic to a high of 35 percent in 2019, with an average of 26 percent. While only an approximation of the

¹¹³ Gov. Code, §§ 11346.3(c)(1)(C), 11346.3(a)(2); 1 CCR § 2003(a)(3) Competitive advantages or disadvantages for California businesses currently doing business in the state.

¹¹⁴ Net private domestic investment is the total amount of investment in capital by the business sector that is used to expand the capital stock, rather than maintain or replace due to depreciation. Corporate profit is the money left after a corporation pays its expenses.

proportion of business income used for net capital investment, the Statewide CASE Team believes it provides a reasonable estimate of the proportion of proprietor income that would be reinvested by business owners into expanding their capital stock.

Table 351: Net Domestic Private Investment and Corporate Profits, U.S.

Year	Net Domestic Private Investment by Businesses, Billions of Dollars	Corporate Profits After Taxes, Billions of Dollars	Ratio of Net Private Investment to Corporate Profits (Percent)
2017	518.473	1882.460	28
2018	636.846	1977.478	32
2019	690.865	1952.432	35
2020	343.620	1908.433	18
2021	506.331	2619.977	19
5-Year Average	-	-	26

Source: (Federal Reserve Economic Data (FRED) n.d.)

The Statewide CASE Team does not anticipate that the economic impacts associated with the proposed measure would lead to significant change (increase or decrease) in investment, directly or indirectly, in any affected sectors of California’s economy. Nevertheless, the Statewide CASE Team can derive a reasonable estimate of the change in investment by California businesses based on the estimated change in economic activity associated with the proposed measure and its expected effect on proprietor income, which the Statewide CASE Team used a conservative estimate of corporate profits, a portion of which the Statewide CASE Team assumed would be allocated to net business investment.¹¹⁵

10.2.4.5 Incentives for Innovation in Products, Materials, or Processes

The Statewide CASE Team does not expect the proposed code change would provide incentives for innovation.

10.2.4.6 Effects on the State General Fund, State Special Funds, and Local Governments

The Statewide CASE Team does not expect the proposed code changes would have a measurable impact on the California’s General Fund, any state special funds, or local government funds.

¹¹⁵ 26 percent of proprietor income was assumed to be allocated to net business investment; see Table 272.

Cost of Enforcement

Cost to the State: State government already has budget for code development, education, and compliance enforcement. While state government would be allocating resources to update the Title 24, Part 6 Standards, including updating education and compliance materials and responding to questions about the revised requirements, these activities are already covered by existing state budgets. The costs to state government are small when compared to the overall costs savings and policy benefits associated with the code change proposals.

Cost to Local Governments: All proposed code changes to Title 24, Part 6 would result in changes to compliance determinations. Local governments would need to train building department staff on the revised Title 24, Part 6 Standards. While this re-training is an expense to local governments, it is not a new cost associated with the 2025 code change cycle. The building code is updated on a triennial basis, and local governments plan and budget for retraining every time the code is updated. There are numerous resources available to local governments to support compliance training that can help mitigate the cost of retraining, including tools, training and resources provided by the IOU Codes and Standards program (such as Energy Code Ace). As noted in Section 10.1.5 and Appendix E, the Statewide CASE Team considered how the proposed code change might impact various market actors involved in the compliance and enforcement process and aimed to minimize negative impacts on local governments.

10.2.4.7 Impacts on Specific Persons

While the objective of any of the Statewide CASE Team's proposal is to promote energy efficiency, the Statewide CASE Team recognizes that there is the potential that a proposed code change may result in unintended consequences. Refer to Section 10.6 for more details addressing energy equity and environmental justice.

10.2.5 Fiscal Impacts

10.2.5.1 Mandates on Local Agencies or School Districts

There are no relevant mandates to school districts, because this only impacts multifamily buildings. There are also no mandates for local agencies because the requirements would be specified at the statewide level through Title 24, Part 6.

10.2.5.2 Costs to Local Agencies or School Districts

There are no costs to school districts, because this only impacts multifamily buildings. For local agencies The Statewide CASE Team does not anticipate any increase in work for building inspectors.

10.2.5.3 Costs or Savings to Any State Agency

There are no costs or savings to state agencies because they would not be involved in enforcement of the measure.

10.2.5.4 Other Non-Discretionary Cost or Savings Imposed on Local Agencies

There are no added non-discretionary costs or savings to local agencies.

10.2.5.5 Costs or Savings in Federal Funding to the State

There are no costs or savings to federal funding to the state due to the measure. The proposed measure is a relatively small cost which the market would bear. The state would not require federal funding to implement the proposed measure.

10.3 Energy Savings

The code change proposal would not modify the stringency of the existing California Energy Code, so there would be no savings on a per-unit basis. Section 5.3 of the CASE Report, which typically presents the methodology, assumptions, and results of the per-unit energy impacts, has been truncated for this proposal.

10.4 Cost and Cost-Effectiveness

10.4.1 Energy Cost Savings Methodology

The code change proposal would not modify the stringency of the existing California Energy Code, so there would be no savings on a per-unit basis. Section 10.4.1 of the CASE Report has been truncated for this proposal.

10.4.2 Energy Cost Savings Results

The code change proposal would not modify the stringency of the existing California Energy Code, so there would be no savings on a per-unit basis. Section 10.4.2 of the CASE Report has been truncated for this proposal.

10.4.3 Incremental First and Retrofit Cost

This measure includes the minimum installation requirements at the time of new construction for components necessary to avoid costly changes and feasibility challenges at the time of an electrification retrofit. The Statewide CASE Team considered first cost, which is the cost at time of construction, and future retrofit cost, which is the future retrofit cost for both electric ready and non-electric ready existing water heating systems. The Statewide CASE Team determined Cost-Effectiveness for the electric-ready measure as the cost savings between installing electric ready

components at the time of construction compared to retrofit costs for a non-electric ready system. The Statewide CASE Team summarized these situations and defined below (see Figure 25):

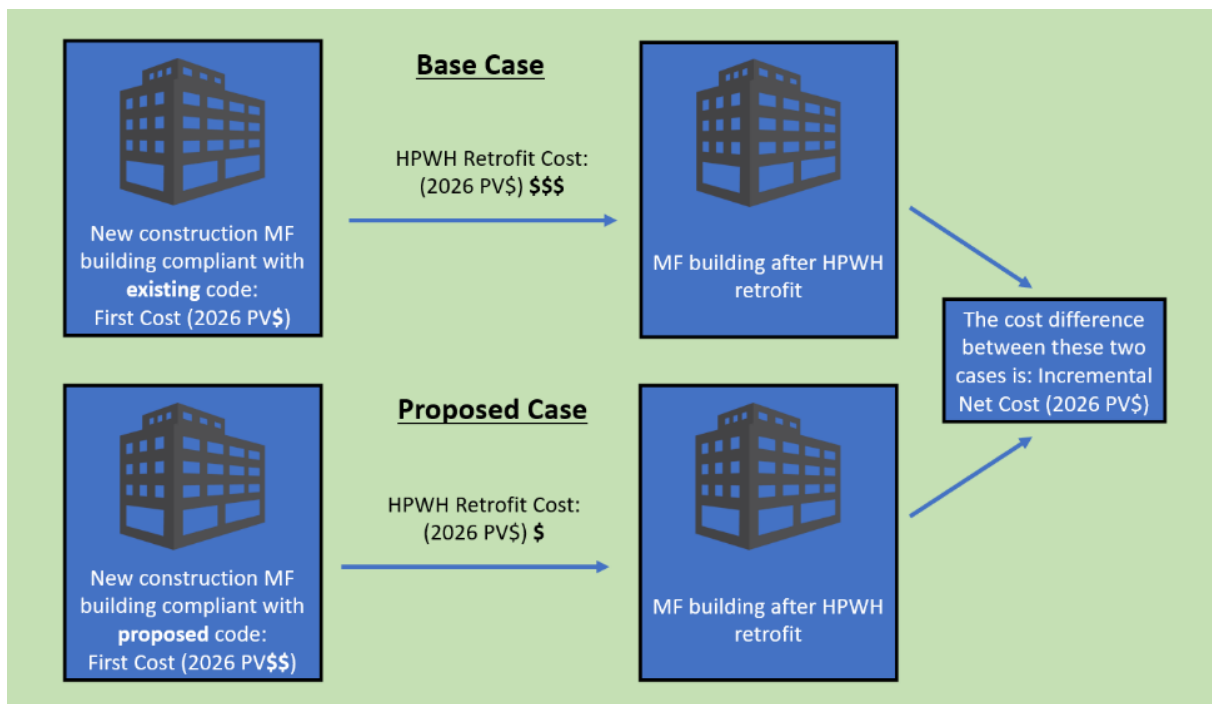

Figure 25: Electric ready base case vs. proposed case.

Incremental first cost at time of new construction:

- **Base Case Non-electric-ready Situation:** Cost of each component based on standard practices with no planning for a future central HPWH. In this report, the Statewide CASE Team refers to this case as “Base Case New Construction.”
- **Proposed Electric-ready Situation:** Cost of each component based on standard practice and implementation of the proposed requirements. In this report the Statewide CASE Team refers to this case as “Proposed Case New Construction”.

The Statewide CASE Team calculated Incremental first cost as defined in **Equation 5**.

$$\begin{aligned}
 & \textit{Incremental First Cost} \\
 & = \textit{Proposed Case New Construction} - \textit{Base Case New Construction}
 \end{aligned}$$

Equation 5

Incremental retrofit cost at time of electrification retrofit:

- **Baseline Non-electric-ready Situation:** Incremental cost of implementing each retrofit component when the existing building met existing electric ready code

requirements. In this report the Statewide CASE Team refers to this case as “Base Case Retrofit”.

- **Proposed Electric-ready Situation:** Incremental cost of implementing each retrofit when the existing building met the proposed electric ready code requirements. In this report the Statewide CASE Team refers to this case as “Proposed Case Retrofit”. The Statewide CASE Team determined that all future costs incurred at time of retrofit for the Proposed Case Retrofit would also be incurred at time of the Base Case Retrofit, and so the incremental cost associated with the proposal at time of retrofit is \$0. In this report the Statewide CASE Team refers to this case as “Proposed Case Retrofit”.

Incremental retrofit cost is calculated as defined in Equation 6.

$$\text{Incremental Retrofit Cost} = \text{Proposed Case Retrofit} - \text{Base Case Retrofit}$$

Equation 6

Incremental first costs are assumed to be valued at 2026 present value (PV), while incremental retrofit costs, which are incurred in the future, need to be adjusted to 2026 PV with Equation 3 adjusted via 2026 PV. The present value of equipment retrofit costs (or savings) was calculated using a three percent discount rate (d), which is consistent with the discount rate used when developing the 2025 Lifecycle Cost Hourly Factors. The present value of retrofit costs that occurs in the nth year is calculated as follows:

$$\text{Present Value of Retrofit Cost} = \text{Retrofit Cost} \times \left[\frac{1}{1 + d} \right]^n$$

Equation 7

The Statewide CASE Team assumed electrification retrofit would occur on year 20.

Building on research findings presented in Section 10.2.2, the Statewide CASE Team identified the greatest barriers to future retrofit of a centralized HPWH system and worked with an experienced plumbing and electrical design consultant firm to develop the basis of design for non-electric ready (baseline) and electric ready (proposed) situations for retrofitting a central gas DHW system to a central HPWH system for the four multifamily prototype buildings. The Statewide CASE Team’s BOD is based on a fully engineered system for standard and low recovery. The Statewide CASE Team worked closely with an electrical engineering and design firm to get cost estimates. The firm provided material and labor cost estimates for entire cost components. Incremental costs for each prototype include material and installation cost for the following items, which are defined in more detail in Section 10.2.2 (See Appendix M for definitions):

1. Building Main Service:
 - a. Main Service Conduit
 - b. Switchboard:
 - i. Pull Section
 - ii. Main Breaker
 - iii. Feeder Breakers
 - iv. Utility Meters Section
2. Markups for Overhead and Profit

The team leveraged electrical load calculations to determine appropriate electrical component sizing by building type for the Time of New Construction Base Case, the Time of Construction Proposed, and the Base Case Retrofit / Proposed Case New Construction which are the same design. In all cases, the electrical load, sizing, and costing data is based on standard practice for electric ready appliances which is to size the entire building system for the future load (as described in Section 10.5.5).

The electrical load calculations were developed for Base Case New Construction, assuming 2022 code compliant prescriptive mixed fuel living units with all-electric heat pump space conditioning, electric ready cook top, and electric ready in unit dryer. The Statewide CASE Team justified not performing an additional analysis for climate zone 16, where electric readiness is required for space conditioning instead of all-electric heat pumps. The Team justified this since the highest full load amps rating of any heat pump is assumed to be 25 amps (for the 3-bedroom unit) which is only 1 amp higher than the 24 full load amps (equivalent to 30 rated amps) required by the current electric ready code language. Only the Low-Rise Loaded Corridor (Quantity 6 3-bedroom Units) and the Mid-Rise Mixed Use (Quantity 8 3-bedroom units) prototypes have 3-bedroom units, and the total impact at the service level is less than 2 amps (at 240/1 volts/phase) for both considering the diversity factors used in the analysis.

The electrical load calculations for Proposed Case New Construction were developed similarly to the electrical load calculations developed for Base Case New Construction, except that planning was performed for the future central HPWH. The electrical load calculations for Base Case Retrofit and Proposed Case Retrofit are the same and were developed similarly to the electrical load calculations for Base Case New Construction, except that the central water heater is a HPWH not a gas water heater. The Proposed Case New Construction, Base Case Retrofit, and Proposed Case Retrofit Cases included two options for HPWH sizing, a low recovery design and a high recovery design, as described in Section 10.5.5.

The calculated electrical loads and designs are the same for all climate zones. An electrical engineer provided cost data for Climate Zone 9. The Statewide CASE Team adjusted material and labor costs collected for each climate zone based on weighting

factors from RS Means provided in the statewide savings calculator for the Statewide CASE Team.

Table 352 through provides a cost summary for electric ready for the proposed electric ready requirements based on Climate Zone 9. The Statewide CASE Team performed additional analysis to rule out certain requirements as not cost effective, and Appendix J includes more detail for cost components that were determined not to be cost effective.

Table 352: Incremental Cost Summary for Electric Ready vs. Non - Electric Ready Cases – Low-Rise Garden Style Standard Recovery System CZ 09

Cost Component	Base Case (Not Electric Ready) ^a Cost at Time of Construction ^c (2026 PV\$)	Proposed Case (Electric Ready) ^b Cost at Time of Construction ^c (2026 PV\$)	Base Case (Not Electric Ready) ^a Retrofit Cost ^d (2026 PV\$)	Proposed Case (Electric Ready) ^b Retrofit Cost ^d (2026 PV\$)
Building Main Service	\$21,612	\$21,612	\$ -	\$ -
Total Incremental First and Retrofit Costs	\$ -	\$ -	\$ -	\$ -

Source: Data provided by electrical design engineers for new construction for both base case and the proposed case.

- Base Case Not Electric Ready:** Cost of electrical equipment specified with no consideration for electric ready heat pump water heating (Per Living Unit).
- Proposed Electric Ready:** Cost of electrical equipment specified with express consideration for electric ready heat pump water heating (Per Living Unit).
- Cost at Time of Construction:** Data provided by electrical design engineers for new construction for both base case and the proposed case.
- Retrofit Cost:** Data provided by electrical design engineers for the cost of retrofitting the electrical system to support an electric heat pump water for both the base case and the proposed case (equal to \$0). Note: The retrofit cost was multiplied by the present value formula assuming replacement at 20 years and three percent discount rate $((1/(1+0.03))^{20} = 0.55368)$.

Table 353: Incremental Cost Summary for Electric Ready vs. Non - Electric Ready Cases – Low-Rise Loaded Corridor Standard Recovery System CZ 09

Cost Component	Base Case (Not Electric Ready) ^a Cost at Time of Construction ^c (2026 PV\$)	Proposed Case (Electric Ready) ^b Cost at Time of Construction ^c (2026 PV\$)	Base Case (Not Electric Ready) ^a Retrofit Cost ^d (2026 PV\$)	Proposed Case (Electric Ready) ^b Retrofit Cost ^d (2026 PV\$)
Building Main Service	\$61,389	\$61,389	\$ -	\$ -
Total Incremental First and Retrofit Costs	\$ -	\$ -	\$ -	\$ -

Source: Data provided by electrical design engineers for new construction for both base case and the proposed case.

- a. **Base Case Not Electric Ready:** Cost of electrical equipment specified with no consideration for electric ready heat pump water heating (Per Living Unit).
- b. **Proposed Electric Ready:** Cost of electrical equipment specified with express consideration for electric ready heat pump water heating (Per Living Unit).
- c. **Cost at Time of Construction:** Data provided by electrical design engineers for new construction for both base case and the proposed case.
- d. **Retrofit Cost:** Data provided by electrical design engineers for the cost of retrofitting the electrical system to support an electric heat pump water for both the base case and the proposed case (equal to \$0). Note: The retrofit cost was multiplied by the present value formula assuming replacement at 20 years and three percent discount rate($(1/(1+0.03))^{20} = 0.55368$).

Table 354: Incremental Cost Summary for Electric Ready vs. Non - Electric Ready Cases – Mid-Rise Mixed Use Standard Recovery System CZ 09

Cost Component	Base Case (Not Electric Ready) ^a Cost at Time of Construction ^c (2026 PV\$)	Proposed Case (Electric Ready) ^b Cost at Time of Construction ^c (2026 PV\$)	Base Case (Not Electric Ready) ^a Retrofit Cost ^d (2026 PV\$)	Proposed Case (Electric Ready) ^b Retrofit Cost ^d (2026 PV\$)
Building Main Service	\$102,316	\$102,316	\$ -	\$ -
Total Incremental First and Retrofit Costs	\$ -	\$ -	\$ -	\$ -

Source: Data provided by electrical design engineers for new construction for both base case and the proposed case.

- a. **Base Case Not Electric Ready:** Cost of electrical equipment specified with no consideration for electric ready heat pump water heating (Per Living Unit).
- b. **Proposed Electric Ready:** Cost of electrical equipment specified with express consideration for electric ready heat pump water heating (Per Living Unit).
- c. **Cost at Time of Construction:** Data provided by electrical design engineers for new construction for both base case and the proposed case.
- d. **Retrofit Cost:** Data provided by electrical design engineers for the cost of retrofitting the electrical system to support an electric heat pump water for both the base case and the proposed case (equal to \$0). Note: The retrofit cost was multiplied by the present value formula assuming replacement at 20 years and three percent discount rate($(1/(1+0.03))^{20} = 0.55368$).

Table 355: Incremental Cost Summary for Electric Ready vs. Non - Electric Ready Cases – High-Rise Mixed Use Standard Recovery System CZ 09

Cost Component	Base Case (Not Electric Ready) ^a Cost at Time of Construction ^c (2026 PV\$)	Proposed Case (Electric Ready) ^b Cost at Time of Construction ^c (2026 PV\$)	Base Case (Not Electric Ready) ^a Retrofit Cost ^d (2026 PV\$)	Proposed Case (Electric Ready) ^b Retrofit Cost ^d (2026 PV\$)
Building Main Service	\$102,316	\$102,316	\$ -	\$ -
Total Incremental First and Retrofit Costs	\$ -	\$ -	\$ -	\$ -

Source: Data provided by electrical design engineers for new construction for both base case and the proposed case.

- a. **Base Case Not Electric Ready:** Cost of electrical equipment specified with no consideration for electric ready heat pump water heating (Per Living Unit).
- b. **Proposed Electric Ready:** Cost of electrical equipment specified with express consideration for electric ready heat pump water heating (Per Living Unit).
- c. **Cost at Time of Construction:** Data provided by electrical design engineers for new construction for both base case and the proposed case.
- d. **Retrofit Cost:** Data provided by electrical design engineers for the cost of retrofitting the electrical system to support an electric heat pump water for both the base case and the proposed case (equal to \$0). Note: The retrofit cost was multiplied by the present value formula assuming replacement at 20 years and three percent discount rate $((1/(1+0.03))^{20} = 0.55368)$.

10.4.4 Incremental Maintenance and Replacement Costs

Incremental maintenance cost is the incremental cost of replacing the equipment or parts of the equipment, as well as periodic maintenance required to keep the equipment operating relative to current practices over the 30-year period of analysis. The Statewide CASE Team found that all equipment components related to the applicable central electric ready methods have a usable life expectancy longer than the 30-year analysis period. Therefore, there are no Lifecycle Cost Hourly Factors to consider.

10.4.5 Cost-Effectiveness

This measure proposes a mandatory requirement. As such, a cost analysis is required to demonstrate that the measure is cost effective. Typically, the CEC establishes the procedures for calculating Cost-Effectiveness, which includes LSC savings from electricity and natural gas-in the evaluation. For electric ready measures, there are no energy cost savings. As discussed in Section 10.4.3, the Statewide CASE Team compared the 2026 present value of incremental first cost and the 2026 present value of incremental retrofit cost to determine Cost-Effectiveness. The electric ready measure is cost effective if the incremental net cost is less than or equal to “0”. The incremental first cost and incremental retrofit costs assuming a 20-year HPWH retrofit were included. Design costs were not included nor were the incremental costs of code compliance verification.

Cost savings between installing electric ready components at the time of construction compared to retrofit costs for a non-electric ready system is calculated as follows in Equation 8 and shown graphically in Figure 25 above.

$\text{Incremental Net Cost} = \text{Incremental First Cost} + \text{Incremental Retrofit Cost}$

Equation 8

It’s important to acknowledge that cost savings associated with this proposal would only be realized if individual HPWHs are installed. At the same time, adoption of HPWH is increasingly driven by maturing technologies, local reach codes, utility programs, and energy conscious consumers. Whether or not the electric ready infrastructure would be

used is an important concern, but the Statewide CASE Team believes that the Cost-Effectiveness analysis presented is the best way to understand the cost-benefit of the proposal given the trends of increasing adoption of individual HPWH. Finally, incremental first costs are based on data available today and can change over time as markets evolve and professionals become familiar with the individual electric ready water heating practices.

Results of the per-unit, cost-effectiveness analyses are presented in Table 356 through Table 364. During proposal development, the Statewide CASE Team determined that some electric ready components would not be cost effective for this measure and these components were dropped from the measure. The Cost-Effectiveness results in this section are for the current proposal as is, and additional data is presented in Appendix J showing components that were considered and determined not cost-effective for this proposal.

Table 356: Cost-Effectiveness Summary Per Dwelling Unit Standard Recovery System Design Averaged by Climate Zone

Building Prototype	Incremental First Cost (2026 PV\$)	Incremental Retrofit Cost (2026 PV\$)	Incremental Net Cost (2026 PV\$)	Cost Effective?
Low-Rise Garden Style	\$0	\$0	\$0	YES
Low-Rise Loaded Corridor	\$0	\$0	\$0	YES
Mid-Rise Mixed Use	\$0	\$0	\$0	YES
High-Rise Mixed Use	\$0	\$0	\$0	YES

- Incremental First Cost (2026 PV\$):** Proposed Case at New Construction Cost – Base Case at New Construction Cost.
- Incremental Retrofit Cost (2026 PV\$):** Base Case Retrofit Cost – Proposed Case Retrofit Cost (equal to \$0). The retrofit cost was multiplied by the present-day value formula assuming replacement at 20 years and three percent discount rate $((1/(1+0.03))^{20} = 0.55368)$.
- Incremental Net Cost (2026 PV\$):** Incremental First Cost – Incremental Retrofit Cost.
- Cost Effective:** “YES” when Total Incremental Cost is negative (Cost Savings) and “NO” when Total Incremental Cost is positive (NO Cost Savings).

Table 357: Cost-Effectiveness Summary Per Dwelling Unit High Recovery System Design Averaged Climate Zone

Building Prototype	Incremental First Cost (2026 PV\$)	Incremental Retrofit Cost (2026 PV\$)	Incremental Net Cost (2026 PV\$)	Cost Effective?
Low-Rise Garden Style	N/A ^a	N/A ^a	N/A ^a	N/A ^a
Low-Rise Loaded Corridor	\$0	\$0	\$0	YES
Mid-Rise Mixed Use	\$0	\$0	\$0	YES
High-Rise Mixed Use	\$0	\$0	\$0	YES

- High recovery not warranted for this prototype.

Table 358: Cost-Effectiveness Summary Per Dwelling Unit and Climate Zone: Low-Rise Garden Style Standard-Recovery HPWH

Climate Zone	Incremental First Cost (2026 PV\$)	Incremental Retrofit Cost (2026 PV\$)	Incremental Net Cost (2026 PV\$)	Cost Effective?
1	\$0	\$0	\$0	YES
2	\$0	\$0	\$0	YES
3	\$0	\$0	\$0	YES
4	\$0	\$0	\$0	YES
5	\$0	\$0	\$0	YES
6	\$0	\$0	\$0	YES
7	\$0	\$0	\$0	YES
8	\$0	\$0	\$0	YES
9	\$0	\$0	\$0	YES
10	\$0	\$0	\$0	YES
11	\$0	\$0	\$0	YES
12	\$0	\$0	\$0	YES
13	\$0	\$0	\$0	YES
14	\$0	\$0	\$0	YES
15	\$0	\$0	\$0	YES
16	\$0	\$0	\$0	YES

High recovery not warranted for Low-Rise Garden Style prototype

- a. **Incremental First Cost (2026 PV\$):** Proposed Case at New Construction Cost – Base Case at New Construction Cost.
- b. **Incremental Retrofit Cost (2026 PV\$):** Base Case Retrofit Cost – Proposed Case Retrofit Cost (equal to \$0). The retrofit cost was multiplied by the present-day value formula assuming replacement at 20 years and three percent discount rate $((1/(1+0.03))^{20} = 0.55368)$.
- c. **Incremental Net Cost (2026 PV\$):** Incremental First Cost – Incremental Retrofit Cost.
- d. **Cost Effective:** “YES” when Total Incremental Cost is negative (Cost Savings) and “NO” when Total Incremental Cost is positive (NO Cost Savings).

Table 359: Cost-Effectiveness Summary Per Dwelling Unit and Climate Zone: Low-Rise Loaded Corridor Standard-Recovery HPWH

Climate Zone	Incremental First Cost (2026 PV\$)	Incremental Retrofit Cost (2026 PV\$)	Incremental Net Cost (2026 PV\$)	Cost Effective?
1	\$0	\$0	\$0	YES
2	\$0	\$0	\$0	YES
3	\$0	\$0	\$0	YES
4	\$0	\$0	\$0	YES
5	\$0	\$0	\$0	YES
6	\$0	\$0	\$0	YES
7	\$0	\$0	\$0	YES
8	\$0	\$0	\$0	YES
9	\$0	\$0	\$0	YES
10	\$0	\$0	\$0	YES
11	\$0	\$0	\$0	YES
12	\$0	\$0	\$0	YES
13	\$0	\$0	\$0	YES
14	\$0	\$0	\$0	YES
15	\$0	\$0	\$0	YES
16	\$0	\$0	\$0	YES

- a. **Incremental First Cost (2026 PV\$):** Proposed Case at New Construction Cost – Base Case at New Construction Cost.
- b. **Incremental Retrofit Cost (2026 PV\$):** Base Case Retrofit Cost – Proposed Case Retrofit Cost (equal to \$0). The retrofit cost was multiplied by the present-day value formula assuming replacement at 20 years and three percent discount rate($(1/(1+0.03))^{20} = 0.55368$).
- c. **Incremental Net Cost (2026 PV\$):** Incremental First Cost – Incremental Retrofit Cost.
- d. **Cost Effective:** “YES” when Total Incremental Cost is negative (Cost Savings) and “NO” when Total Incremental Cost is positive (NO Cost Savings).

Table 360: Cost-Effectiveness Summary Per Dwelling Unit and Climate Zone: Low-Rise Loaded Corridor High-Recovery HPWH

Climate Zone	Incremental First Cost (2026 PV\$)	Incremental Retrofit Cost (2026 PV\$)	Incremental Net Cost (2026 PV\$)	Cost Effective?
1	\$0	\$0	\$0	YES
2	\$0	\$0	\$0	YES
3	\$0	\$0	\$0	YES
4	\$0	\$0	\$0	YES
5	\$0	\$0	\$0	YES
6	\$0	\$0	\$0	YES
7	\$0	\$0	\$0	YES
8	\$0	\$0	\$0	YES
9	\$0	\$0	\$0	YES
10	\$0	\$0	\$0	YES
11	\$0	\$0	\$0	YES
12	\$0	\$0	\$0	YES
13	\$0	\$0	\$0	YES
14	\$0	\$0	\$0	YES
15	\$0	\$0	\$0	YES
16	\$0	\$0	\$0	YES

- a. **Incremental First Cost (2026 PV\$):** Proposed Case at New Construction Cost – Base Case at New Construction Cost.
- b. **Incremental Retrofit Cost (2026 PV\$):** Base Case Retrofit Cost – Proposed Case Retrofit Cost (equal to \$0). The retrofit cost was multiplied by the present-day value formula assuming replacement at 20 years and three percent discount rate($(1/(1+0.03))^{20} = 0.55368$).
- c. **Incremental Net Cost (2026 PV\$):** Incremental First Cost – Incremental Retrofit Cost.
- d. **Cost Effective:** “YES” when Total Incremental Cost is negative (Cost Savings) and “NO” when Total Incremental Cost is positive (NO Cost Savings).

Table 361: Cost-Effectiveness Summary Per Dwelling Unit and Climate Zone: Mid-Rise Standard-Recovery HPWH

Climate Zone	Incremental First Cost (2026 PV\$)	Incremental Retrofit Cost (2026 PV\$)	Incremental Net Cost (2026 PV\$)	Cost Effective?
1	\$0	\$0	\$0	YES
2	\$0	\$0	\$0	YES
3	\$0	\$0	\$0	YES
4	\$0	\$0	\$0	YES
5	\$0	\$0	\$0	YES
6	\$0	\$0	\$0	YES
7	\$0	\$0	\$0	YES
8	\$0	\$0	\$0	YES
9	\$0	\$0	\$0	YES
10	\$0	\$0	\$0	YES
11	\$0	\$0	\$0	YES
12	\$0	\$0	\$0	YES
13	\$0	\$0	\$0	YES
14	\$0	\$0	\$0	YES
15	\$0	\$0	\$0	YES
16	\$0	\$0	\$0	YES

- a. **Incremental First Cost (2026 PV\$):** Proposed Case at New Construction Cost – Base Case at New Construction Cost.
- b. **Incremental Retrofit Cost (2026 PV\$):** Base Case Retrofit Cost – Proposed Case Retrofit Cost (equal to \$0). The retrofit cost was multiplied by the present-day value formula assuming replacement at 20 years and three percent discount rate($(1/(1+0.03))^{20} = 0.55368$).
- c. **Incremental Net Cost (2026 PV\$):** Incremental First Cost – Incremental Retrofit Cost.
- d. **Cost Effective:** “YES” when Total Incremental Cost is negative (Cost Savings) and “NO” when Total Incremental Cost is positive (NO Cost Savings).

Table 362: Cost-Effectiveness Summary Per Dwelling Unit and Climate Zone: Mid-Rise High-Recovery HPWH

Climate Zone	Incremental First Cost (2026 PV\$)	Incremental Retrofit Cost (2026 PV\$)	Incremental Net Cost (2026 PV\$)	Cost Effective?
1	\$0	\$0	\$0	YES
2	\$0	\$0	\$0	YES
3	\$0	\$0	\$0	YES
4	\$0	\$0	\$0	YES
5	\$0	\$0	\$0	YES
6	\$0	\$0	\$0	YES
7	\$0	\$0	\$0	YES
8	\$0	\$0	\$0	YES
9	\$0	\$0	\$0	YES
10	\$0	\$0	\$0	YES
11	\$0	\$0	\$0	YES
12	\$0	\$0	\$0	YES
13	\$0	\$0	\$0	YES
14	\$0	\$0	\$0	YES
15	\$0	\$0	\$0	YES
16	\$0	\$0	\$0	YES

- a. **Incremental First Cost (2026 PV\$):** Proposed Case at New Construction Cost – Base Case at New Construction Cost.
- b. **Incremental Retrofit Cost (2026 PV\$):** Base Case Retrofit Cost – Proposed Case Retrofit Cost (equal to \$0). The retrofit cost was multiplied by the present-day value formula assuming replacement at 20 years and three percent discount rate($(1/(1+0.03))^{20} = 0.55368$).
- c. **Incremental Net Cost (2026 PV\$):** Incremental First Cost – Incremental Retrofit Cost.
- d. **Cost Effective:** “YES” when Total Incremental Cost is negative (Cost Savings) and “NO” when Total Incremental Cost is positive (NO Cost Savings).

Table 363: Cost-Effectiveness Summary Per Dwelling Unit and Climate Zone: High-Rise Standard-Recovery HPWH

Climate Zone	Incremental First Cost (2026 PV\$)	Incremental Retrofit Cost (2026 PV\$)	Incremental Net Cost (2026 PV\$)	Cost Effective?
1	\$0	\$0	\$0	YES
2	\$0	\$0	\$0	YES
3	\$0	\$0	\$0	YES
4	\$0	\$0	\$0	YES
5	\$0	\$0	\$0	YES
6	\$0	\$0	\$0	YES
7	\$0	\$0	\$0	YES
8	\$0	\$0	\$0	YES
9	\$0	\$0	\$0	YES
10	\$0	\$0	\$0	YES
11	\$0	\$0	\$0	YES
12	\$0	\$0	\$0	YES
13	\$0	\$0	\$0	YES
14	\$0	\$0	\$0	YES
15	\$0	\$0	\$0	YES
16	\$0	\$0	\$0	YES

- a. **Incremental First Cost (2026 PV\$):** Proposed Case at New Construction Cost – Base Case at New Construction Cost.
- b. **Incremental Retrofit Cost (2026 PV\$):** Base Case Retrofit Cost – Proposed Case Retrofit Cost (equal to \$0). The retrofit cost was multiplied by the present-day value formula assuming replacement at 20 years and three percent discount rate($(1/(1+0.03))^{20} = 0.55368$).
- c. **Incremental Net Cost (2026 PV\$):** Incremental First Cost – Incremental Retrofit Cost.
- d. **Cost Effective:** “YES” when Total Incremental Cost is negative (Cost Savings) and “NO” when Total Incremental Cost is positive (NO Cost Savings).

Table 364: Cost-Effectiveness Summary Per Dwelling Unit and Climate Zone: High-Rise High-Recovery HPWH

Climate Zone	Incremental First Cost (2026 PV\$)	Incremental Retrofit Cost (2026 PV\$)	Incremental Net Cost (2026 PV\$)	Cost Effective?
1	\$0	\$0	\$0	YES
2	\$0	\$0	\$0	YES
3	\$0	\$0	\$0	YES
4	\$0	\$0	\$0	YES
5	\$0	\$0	\$0	YES
6	\$0	\$0	\$0	YES
7	\$0	\$0	\$0	YES
8	\$0	\$0	\$0	YES
9	\$0	\$0	\$0	YES
10	\$0	\$0	\$0	YES
11	\$0	\$0	\$0	YES
12	\$0	\$0	\$0	YES
13	\$0	\$0	\$0	YES
14	\$0	\$0	\$0	YES
15	\$0	\$0	\$0	YES
16	\$0	\$0	\$0	YES

- a. **Incremental First Cost (2026 PV\$):** Proposed Case at New Construction Cost – Base Case at New Construction Cost.
- b. **Incremental Retrofit Cost (2026 PV\$):** Base Case Retrofit Cost – Proposed Case Retrofit Cost (equal to \$0). The retrofit cost was multiplied by the present-day value formula assuming replacement at 20 years and three percent discount rate($(1/(1+0.03))^{20} = 0.55368$).
- c. **Incremental Net Cost (2026 PV\$):** Incremental First Cost – Incremental Retrofit Cost.
- d. **Cost Effective:** “YES” when Total Incremental Cost is negative (Cost Savings) and “NO” when Total Incremental Cost is positive (NO Cost Savings).

10.5 Annual Statewide Impacts

The code change proposal would not modify the stringency of the existing California Energy Code, so the savings associated with this proposed change are minimal. Typically, the Statewide CASE Team presents a detailed analysis of statewide energy and energy cost savings associated with the proposed change in this section of the report.

10.5.1 Statewide Energy and Energy Cost Savings

There are no energy savings associated with this measure.

10.5.2 Statewide GHG Emissions Reductions

There are no GHG Emissions associated with this measure.

10.5.3 Statewide Water Use Impacts

The proposed code change would not result in water savings.

10.5.4 Statewide Material Impacts

The proposed changes resulted in higher infrastructure requirement which resulted in increased usage of Copper, Steel and Plastic. See Appendix D for more details.

Table 365: Annual Statewide Impacts on Material Use – Central DHW Electric Ready

Material	Impact	Per-Unit Impacts (Pounds per Dwelling Units)	Annual ^a Statewide Impacts (Pounds)
Copper	Increase	12.77	224,480
Plastic	Increase	1.59	28,060
TOTAL	-	-	-

a. First-year savings from all buildings completed statewide in 2026.

10.5.5 Other Non-Energy Impacts

The proposed code change would not result in other non-energy impacts.

10.6 Addressing Energy Equity and Environmental Justice

The Statewide CASE Team assessed the potential impacts of the proposed measure on DIPs. See Section 2 for a summary of research methods and potentially impacted populations, as well as other general potential equity impacts (Meng, et al. 2007) (CALEPA 2022).

10.6.1 Potential Impacts

Positive effects of building electrification on DIPs, based on future adoption of heat pump water heating equipment as a result of the electric ready requirements include increased resiliency and health impacts, which are discussed in detail in Section 2.2.2, with impacts on potentially impacted populations as described in Section 2.2.1.

11. Proposed Revisions to Code Language

11.1 Guide to Markup Language

The proposed changes to the standards, Reference Appendices, and the ACM Reference Manuals are provided below. Changes to the 2022 documents are marked with red underlining (new language) and ~~strikethroughs~~ (deletions).

11.2 Standards

SECTION 100.1 – DEFINITIONS AND RULES OF CONSTRUCTION

Section 100.1(b) – Definitions: Recommends new or revised definitions for the following terms:

AHRI 540 is the Air-Conditioning, Heating, and Refrigeration Institute document titled “Performance Rating of Positive Displacement Refrigerant Compressors and Compressor Units,” 2020 (AHRI Standard 540-2020)

AIR-TO-WATER HEAT PUMP (AWHP) is a factory-made packaged heat pump system containing one or more compressors, refrigerant-to-air and refrigerant-to-water heat exchangers, and other components for providing heated or cooled water for satisfying space conditioning loads, and in some cases domestic hot water requirements.

CONSUMER WATER HEATER is a water heater that meets the definition of a consumer product under USDOE 10 CFR 430.

HEAT PUMP WATER HEATER (HPWH) is a water heater that transfers thermal energy from one temperature level to ~~another higher temperature level~~ for the purpose of heating water, including all ancillary equipment such as fans, storage tanks, pumps, or controls necessary for the device to perform its function.

~~**SINGLE-PASS HEAT PUMP WATER HEATER** is a HPWH which the cold water passes through the heat pump(s) once and is heated to the intended storage temperature.~~

~~**MULTI-PASS HEAT PUMP WATER HEATER** is a HPWH which the cold water passes through the heat pump(s) multiple times, each time gaining a temperature increase, until the tank reaches the intended storage temperature.~~

INTEGRATED HEAT PUMP WATER HEATER is a HPWH which has all components, including fans, storage tanks, pumps, or controls necessary for the device to perform its function contained in a single factory-made assembly.

SPLIT-REFRIGERANT HEAT PUMP WATER HEATER is a HPWH which has a single outdoor section and one or more indoor sections connected to the outdoor section via a refrigerant circuit.

SPLIT-HYDRONIC HEAT PUMP WATER HEATER is a HPWH which has two distinct sections, one which has all refrigerant containing components and one or more storage sections, with all sections connected via a hydronic circuit.

SINGLE-PASS WATER HEATER is a water heater which the cold water passes through once and is heated to the intended use temperature.

MULTI-PASS WATER HEATER is a water heater which the cold water passes through multiple times, each time gaining a temperature increase, until the storage tank reaches the intended storage temperature.

NET FREE AREA (NFA) is the total unobstructed area of the air gaps between louver and grille slats in a vent through which air can pass. The narrowest distance between two slats, perpendicular to the surface of both slats is the air gap height. The narrowest width of the gap is the air gap width. The NFA is the air gap height multiplied by the air gap width multiplied by the total number of air gaps between slats in the vent.

DOMESTIC HOT WATER SYSTEM APPURTENANCE are all elements that are in series in a domestic hot water distribution system, including fittings (elbows, tees, flanges, etc.), pumps, valves (isolation, mixing, balancing, check, etc.), pipe supports and hangers, strainers, hose bibs, coil u-bends, meters, sensors, heat exchangers and air separators.

SECTION 110.3 – MANDATORY REQUIREMENTS FOR SERVICE WATER-HEATING SYSTEMS AND EQUIPMENT

Section 110.3(c) – Installation: Recommends new subsection as follows:

7. Heat pump water heaters (HPWHs).

- A. **Backup Heat.** Backup heat is required for air-source systems when inlet air is unconditioned, unless the compressor cutout temperature is below the Winter Median of Extremes for the closest location listed in Table 2-3 from Reference Joint Appendix JA2.
- B. **Ventilation.** Ventilation air for consumer integrated HPWHs shall be obtained by one of the methods below. Minimum volume and opening size requirements shall be the sum for all HPWHs installed in the same space. Compressor capacity shall be determined using AHRI 540 Table 4 reference conditions for refrigeration with the “High” rating test point.
 1. Installed without ducts in a space with a minimum volume the larger of 100 cu. ft. per kBtu/hr of compressor capacity or the minimum provided by the manufacturer for this method.

2. Installed without ducts in a space smaller than required by subsection 1 above, according to the following requirements:
 - i. Installation space shall be the larger of 20 cu. ft. per kBtu/hr of compressor capacity or the minimum provided by the manufacturer for this method, and vented to a communicating space via permanent openings.
 - ii. Communicating space shall meet the minimum volume of subsection 1, minus the volume of the installation space.
 - iii. Permanent openings shall consist of a single layer of fixed flat slat louvers or grilles with a total minimum NFA the larger of 125 sq. in. plus 25 sq. in. per kBtu/hr of compressor capacity or the minimum provided by the manufacturer for this method, and meet the following requirements:
 - a. Fully louvered doors; or
 - b. Two openings, one commencing within 12 inches from the enclosure top and one commencing within 12 inches from the enclosure bottom.
3. Installed with ducts in any size space, according to manufacturer requirements and the following:
 - i. The space joined to the installation space via ducts shall meet the minimum volume of subsection 1, minus the volume of the installation space.
 - ii. All duct connections and building penetrations shall be sealed.
 - iii. Exhaust air ducts and all ducts which cross pressure boundaries shall be insulated to R-6 or higher.
 - iv. If only the HPWH inlet or outlet is ducted, installation space shall include permanent openings consisting of a single layer of fixed flat slat louvers or grilles in the bottom half of the room, and/or a door undercut. With a ducted inlet, minimum NFA shall be equal to the cross-sectional area of the duct. With a ducted exhaust, the minimum NFA shall be equal to the larger of 20 sq. in. or the minimum NFA provided by the manufacturer for this method.
 - v. If inlet and outlet ducts terminate within the same pressure boundary, airflow from termination points shall be diverted away from each other.

4. Installed using a method for ventilation, other than those described in subsections 1 through 3, certified by the manufacturer. A letter from the manufacturer providing this certification shall be included with plans submitted to the enforcement agency for approval.

SECTION 150.0 – MANDATORY FEATURES AND DEVICES

(n) Water Heating System.

1. Systems using gas or propane water heaters to serve individual dwelling units shall designate a space at least 2.5 feet by 2.5 feet wide and 7 feet tall suitable for the future installation of a heat pump water heater (HPWH) by meeting either A or B below. All electrical components shall be installed in accordance with the California Electrical Code:
 - A. If the designated space is within 3 feet from the water heater, then this space shall include the following:
 - i. A dedicated 125 volt, 20 amp electrical receptacle that is connected to the electric panel with a 120/240 volt 3 conductor, ~~10 AWG copper~~ branch circuit rated to 30 amps, within 3 feet from the water heater and accessible to the water heater with no obstructions; and

SECTION 160.4 – MANDATORY REQUIREMENTS FOR WATER HEATING SYSTEMS

(Note to reviewer: Section 160.4 (a) moved to 160.9 as part of the electric ready measure proposal)

(a) Systems using gas or propane water heaters to serve individual dwelling units shall include the following components:

- ~~1. A dedicated 125 volt, 20 amp electrical receptacle that is connected to the electric panel with a 120/240 volt 3 conductor, 10 AWG copper branch circuit, within 3 feet from the water heater and accessible to the water heater with no obstructions. In addition, all of the following:
 - A. Both ends of the unused conductor shall be labeled with the word “spare” and be electrically isolated; and
 - B. A reserved single pole circuit breaker space in the electrical panel adjacent to the circuit breaker for the branch circuit in A above and labeled with the words “Future 240V Use”; and~~
2. A Category III or IV vent, or a Type B vent with straight pipe between the outside termination and the space where the water heater is installed; and

- ~~3. A condensate drain that is no more than 2 inches higher than the base of the installed water heater, and allows natural draining without pump assistance, and~~
4. A gas supply line with a capacity of at least 200,000 Btu/hr.

(f) Pipe Insulation for piping and tanks

- b. All piping for multifamily domestic hot water systems shall be insulated to meet the requirements of Table 160.4-A. Multifamily buildings shall comply with the applicable requirements of Sections 160.4(f)1A through 160.4(f)1E.

1. Insulation Requirements.

- b. The first 8 feet of inlet cold water piping from the storage tanks, including piping between a storage tank and a heat trap shall be insulated.
 - c. Insulation on the piping and appurtenances shall be continuous.
 - d. Pipe supports, hangers, and pipe clamps shall be attached on the outside of rigid pipe insulation to prevent thermal bridges.
 - e. All pipe insulation seams shall be sealed.
 - f. Insulation for pipe elbows shall be mitered, preformed, or site fabricated with PVC covers.
 - g. Insulation for tees shall be notched, preformed, or site fabricated with PVC covers.
 - h. Extended stem isolation valves shall be installed.
 - i. All plumbing appurtenances on hot water piping from a heating source to heating plant, at the heating plant, and distribution supply and return piping shall be insulated to meet the following requirements:
 - a. Where the outer diameter of the appurtenance is less than the outer diameter of the insulated pipe that it is attached to, the appurtenance shall be insulated flush with the insulation surrounding the pipe.
 - b. Where the outer diameter of the appurtenance is greater than the outer diameter of the insulated pipe that it is attached to, the appurtenance shall be insulated with a minimum thickness of 1".
 - c. The insulation shall be removable and re-installable to ensure maintenance or replacement services can be completed.
 - d. The insulation shall not impede the functionality of the valve (e.g., opening and closing an isolation valve).
2. Insulation conductivity shall be determined in accordance with ASTM C335 at the mean temperature listed in Table 160.4-A, and shall be rounded to the

nearest 1/100 Btu-inch per hour per square foot per °F. Hot water piping includes the pipe or tube and the fittings (elbows, tees, couplings, etc.). Plumbing appurtenances include all elements that are in series with the hot water piping, such as flanges, pumps, valves (isolation, mixing, balancing, check, etc.), strainers, hose bibs, meters, sensors, heat exchangers and air separators.

3. **Insulation protection.** Pipe insulation shall be protected from damage due to sunlight, moisture, equipment maintenance and wind. Protection shall, at minimum, include the following:

- i. Pipe insulation exposed to weather shall be protected by a cover suitable for outdoor service. The cover shall be water retardant and provides shielding from solar radiation that can cause degradation of the material. Adhesive tape shall not be used to provide this protection.
- ii. Pipe insulation buried below grade must be installed in a waterproof and noncrushable casing or sleeve.

4. **Insulation thickness.**

4.1 For insulation with a conductivity in the range shown in Table 160.4-A for the applicable fluid temperature range, the insulation shall have the applicable minimum thickness or R-value shown in Table 160.4-A.

4.2 For insulation with a conductivity outside the range shown in Table 160.4-A for the applicable fluid temperature range, the insulation shall have a minimum R-value shown in Table 160.4-A or thickness as calculated with Equation 160.4-A:

$$T = PR \left[\left(1 + \frac{t}{PR} \right)^{\frac{K}{k}} - 1 \right]$$

(Equation 160.4-A)

WHERE:

T = insulation thickness for material with conductivity K, inches.

PR = actual outside radius, inches.

t = Insulation thickness from Table 160.4-A, inches.

K = Conductivity of alternate material at the mean rating temperature indicated in Table 160.4-A for the applicable fluid temperature range, in Btu-inch per hour per square foot per °F.

k = The lower value of the conductivity range listed in Table 160.4-A for

the applicable fluid temperature range, Btu-inch per hour per square foot per °F.

5. Insulation verification.

- i. For central systems with hot water piping serving multiple dwelling units, heating plant and recirculation system piping insulation quality shall be field verified and meet the requirements specified in the Nonresidential and Multifamily Reference Appendix RA3.6.10.

Exception 1 to Section 160.4(f)1: ~~Factory-installed piping within space-conditioning equipment certified under Section 110.1 or 110.2. Reserved.~~

Exception 2 to Section 160.4(f)1: Piping that penetrates framing members shall not be required to have pipe insulation for the distance of the framing penetration. Piping that penetrates metal framing shall use grommets, plugs, wrapping or other insulating material to ensure that no contact is made with the metal framing. Insulation shall abut securely against all framing members.

Exception 3 to Section 160.4(f)1: Piping installed in interior or exterior walls shall not be required to have pipe insulation if all the requirements are met for compliance with quality insulation installation (QII) as specified in Reference Residential Appendix RA3.5.

Exception 4 to Section 160.4(f)1: Piping surrounded with a minimum of 1 inch of wall insulation, 2 inches of crawl space insulation or 4 inches of attic insulation shall not be required to have pipe insulation.

TABLE 160.4-A PIPE INSULATION THICKNESS

Fluid Operating Temperature Range (°F)	Insulation Conductivity			Nominal Pipe Diameter (in inches)				
	Conductivity (in Btu-in/h-ft ² -°F)	Mean Rating Temperature (°F)		< 1	1 to <1.5	1.5 to < 4	4 to < 8	8 and larger
Multifamily Domestic Hot Water Systems				Minimum Pipe Insulation Required (Thickness in inches or R-value)				
105-140 ¹	0.22-0.28	100	Inches	1.0	1.5	2.0	2.0	2.0
			R-value	R 7.7	R 12.5	R 16	R 12.5	R 11

1. Footnote to TABLE 160.4-1. Multifamily and hotel/motel domestic hot water systems with water temperature above 140°F shall use the row in Table 120.3-A for the applicable water temperature.

SECTION 160.9 – MANDATORY REQUIREMENTS FOR ELECTRIC READY BUILDINGS

(a) **Heat Pump Space Heater Ready.** Systems using gas or propane furnaces to serve individual [dwelling](#) units shall include the following and shall meet the requirements of Section 160.9(f):

1. A dedicated 240 volt branch circuit wiring shall be installed within 3 feet from the furnace and [accessible](#) to the furnace with no obstructions. The branch circuit conductors shall be rated at 30 amps minimum. The blank cover shall be identified as “240V ready”. All electrical components shall be installed in accordance with the *California Electrical Code*.
2. The main electrical [service](#) panel shall have a reserved space to allow for the installation of a double pole circuit breaker for a future [heat pump](#) space heater installation. The reserved space shall be permanently marked as “For Future 240V use”.

(b) **Electric Cooktop Ready.** Systems using gas or propane cooktops to serve individual [dwelling](#) units shall include the following and shall meet the requirements of Section 160.9(f):

1. A dedicated 240 volt branch circuit wiring shall be installed within 3 feet from the cooktop and [accessible](#) to the cooktop with no obstructions. The branch circuit conductors shall be rated at 50 amps minimum. The blank cover shall be identified as “240V ready”. All electrical components shall be installed in accordance with the *California Electrical Code*.
2. The main electrical [service](#) panel shall have a reserved space to allow for the installation of a double pole circuit breaker for a future electric cooktop installation. The reserved space shall be permanently marked as “For Future 240V use”.

(c) **Electric Clothes Dryer Ready.** Clothes dryer locations with gas or propane plumbing shall include the following and shall meet the requirements of Section 160.9(f):

1. Systems serving individual dwelling units shall include:

- A. A dedicated 240 volt branch circuit wiring shall be installed within 3 feet from the clothes dryer location and [accessible](#) to the clothes dryer location with no obstructions. The branch circuit conductors shall be rated at 30 amps minimum. The blank cover shall be identified as “240V ready”. All electrical components shall be installed in accordance with the *California Electrical Code*.
 - B. The main electrical [service](#) panel shall have a reserved space to allow for the installation of a double pole circuit breaker for a future electric clothes dryer installation. The reserved space shall be permanently marked as “For Future 240V use”.
2. Systems in common use areas shall include:

- A. Conductors or raceway shall be installed with termination points at the main electrical panel, via subpanels if applicable, to a location no more than 3 feet from each gas outlet or a designated location of future electric replacement equipment. Both ends of the conductors or raceway shall be labelled “Future 240V Use.”~~The conductors or raceway and any intervening subpanels, panelboards, switchboards, and busbars shall be sized to meet the future electric power requirements, at the service voltage to the point at which the conductors serving the building connect to the utility distribution system, as specified below. The capacity requirements may be adjusted for demand factors in accordance with the California Electric Code.~~ Gas flow rates shall be determined in accordance with the California Plumbing Code. Capacity shall be one of the following:
 - i. 24 amps at 208/240 volts per clothes dryer.
 - ii. 2.6 kVA for each 10,000 Btu per hour of rated gas input or gas capacity; or
 - iii. The electrical power required to provide equivalent functionality of the gas-powered equipment as calculated and documented by the responsible person associated with the project.

(d) Individual Heat Pump Water Heater Ready. Systems using gas or propane water heaters to serve individual dwelling units shall include the following components and shall meet the requirements of Section 160.9(f):

- 1. A dedicated 125 volt, 20 amp electrical receptacle that is connected to the electric panel with a 120/240 volt 3 conductor branch circuit rated to 30 amps minimum, within 3 feet from the water heater and accessible to the water heater with no obstructions. In addition, all the following:

- A. Both ends of the unused conductor shall be labeled with the word “spare” and be electrically isolated; and
- B. A reserved single pole circuit breaker space in the electrical panel adjacent to the circuit breaker for the branch circuit in A above and labeled with the words “Future 240V Use”; and
- 2. A condensate drain that is no more than 2 inches higher than the base of the installed water heater, and allows natural draining without pump assistance, and
- 3. The construction drawings shall indicate the location of the future heat pump water heater. The reserved location shall have minimum interior dimensions of 39”x39”x96”
- 4. A ventilation method meeting one of the following:
 - A. The location reserved for the future heat pump water heater shall have a minimum volume of 700 cu. ft. or
 - B. The location reserved for the future heat pump water heater shall vent to a communicating space in the same pressure boundary via permanent openings with a minimum total NFA of 250 sq. in., so that the total combined volume connected via permanent openings is 700 cu. ft. or larger. The permanent openings shall be:
 - i. Fully louvered doors with fixed louvers consisting of a single layer of fixed flat slats; or
 - ii. Two permanent fixed openings, consisting of a single layer of fixed flat slat louvers or grilles, one commencing within 12 inches from the top of the enclosure and one commencing within 12 inches from the bottom of the enclosure.
 - C. The location reserved for the future heat pump water heater shall include two 8” capped ducts, venting to the building exterior:
 - i. All ducts connections and building penetrations shall be sealed.
 - ii. Exhaust air ducts and all ducts which cross pressure boundaries shall be insulated to a minimum insulation level of R-6.
 - iii. Airflow from termination points shall be diverted away from each other.

(e) Central Heat Pump Water Heater Ready. Water heating systems using gas or propane to serve multiple dwelling units shall meet the requirements of 160.9(f) and include the following for the future heat pump:

1. The system input capacity of the gas or propane water heating system shall be determined as the sum of the input gas or propane capacity of all water heating devices associated with each gas or propane water heating system.
2. Space reserved shall include:
 - A. Heat Pump. The minimum space reserved shall include space for service clearances and air flow clearances and shall meet one of the following:
 - i. The space reserved shall be the space required for a heat pump water heater system that meets the total building hot water demand as calculated and documented by the responsible person associated with the project.
 - ii. The space reserved shall meet the requirements specified in Joint Appendix JA15.3.1
 - B. Tanks. The minimum space reserved shall include space for service clearances and shall meet one of the following:
 - i. The space reserved shall be the space required for a heat pump water heater system that meets the total building hot water demand as calculated and documented by the responsible person associated with the project.
 - ii. The space reserved shall meet the requirements specified in Joint Appendix JA15.3.2
3. Ventilation shall be provided by meeting one of the following:
 - A. Physical space reserved for the heat pump shall be located outside, or
 - B. A pathway shall be reserved for future routing of supply and exhaust air via ductwork from the reserved heat pump location to an appropriate outdoor location. Penetrations through the building envelope for louvers and ducts shall be planned and identified for future use. The reserved pathway and penetrations through the building envelope shall be sized to meet one of the following:
 - i. The reserved pathway and penetrations shall be sized to serve a heat pump water heater system that meets the total building hot water demand as calculated and documented by the responsible person associated with the project.

- ii. The reserved pathway and penetrations shall be sized to meet the requirements specified in Joint Appendix JA15.3.3
- 4. Condensate drainage piping. An approved receptacle that is sized per the California Plumbing Code to receive the condensate drainage shall be installed within 3 feet of the reserved heat pump location, or piping shall be installed from within 3 feet of the reserved heat pump location to an approved discharge location that is sized in accordance with the California Plumbing Code, and meet one of the following:
 - i. Condensate drainage shall be sized to serve a heat pump water heater system that meets the total building hot water demand as calculated and documented by the responsible person associated with the project.
 - ii. Condensate drainage piping shall be sized to meet the requirements specified in Joint Appendix JA15.3.4
- 5. Electrical
 - A. Physical space shall be reserved on the bus system of the main switchboard or on the bus system of a distribution board to serve the future heat pump water heater system including the heat pump and temperature maintenance tanks. In addition, the physical space reserved shall be capable of providing adequate power to the future heat pump water heater in accordance with the following:
 - i. Heat Pump. Meet one of the following.
 - A. The electrical power required to power a heat pump water heater system heat pump that meets the total building hot water demand as calculated and documented by the responsible person associated with the project.
 - B. The electrical power required that meets the requirements specified for the heat pump in Joint Appendix JA15.3.5
 - ii. Temperature Maintenance Tank. Meet one of the following.
 - A. The electrical power required to power a heat pump water heater system temperature maintenance tank that meets the total building hot water demand as calculated and documented by the responsible person associated with the project.

- B. The electrical power required that meets the requirements specified for the temperature maintenance tank in Joint Appendix JA15.3.5

(f) The building electrical system shall be sized to meet the future electric requirements of the electric ready equipment specified in sections 160.9 a – e. To meet this requirement the building main service conduit, the electrical system to the point specified in each subsection, and any on-site distribution transformers shall have sufficient capacity to supply full rated amperage at each electric ready appliance in accordance with the California Electrical Code.

NOTE: Authority: Sections 25213, 25218, 25218.5, 25402 and 25402.1, Public Resources Code. Reference: Sections 25007, 25008, 25218.5, 25310, 25402, 25402.1, 25402.4, 25402.5, 25402.8, and 25943, Public Resources Code.

Section 170.1 – Performance Approach

(d) Compliance Demonstration Requirements for Performance Standards.

- k. Thermal Balancing Valve compliance option. When performance compliance requires installation of thermal balancing valves with variable speed circulation pump(s), the installation shall meet the procedures in Reference Residential Appendix RA4.4.3.

NOTE: Authority: Sections 25213, 25218, 25218.5, 25402 and 25402.1, Public Resources Code. Reference: Sections 25007, 25008, 25218.5, 25310, 25402, 25402.1, 25402.4, 25402.5, 25402.8, and 25943, Public Resources Code.

Section 170.2 PRESCRIPTIVE APPROACH

~~(d) Water Heating Systems Water-heating systems shall meet the requirements of either 1, 2, 3 or 4.~~

~~For recirculation distribution systems serving individual dwelling units, only demand recirculation systems with manual on/off control as specified in the Reference Appendix RA4.4.9 shall be used. Recirculation system serving multiple dwelling units shall meet the requirements of Sections 110.3(c)2 and 110.3(c)5, and shall be capable of automatically controlling the recirculation pump operation based on measurement of hot water demand and hot water return temperature:~~

(d) Domestic Hot Water System. Domestic hot water systems shall meet the requirements of either 1 or 2.

1. For systems serving individual dwelling units, the water heating system shall meet the requirement of A and B. ~~or shall meet the performance compliance requirements of Section 170.1:~~
 - A. The water heating system shall meet the requirement of either i, ii, iii, or meet the performance compliance requirements of Section 170.1:

- i. A single 240 volt heat pump water heater. In addition, meet the following:
 - I. A compact hot water distribution system as specified in the Reference Appendix RA4.4.6. in climate 1 and 16; ~~and~~
 - II. A drain water heat recovery system that is field verified as specified in the Reference Appendix RA3.6.9 in Climate Zone 16; ~~and~~
 - III. Installation shall meet requirements specified in Section 110.3 (c).
 - ii. A single heat pump water heater that meets the requirements of NEEA Advanced Water Heater Specification Tier 3 or higher. In addition, for Climate Zone 16, a drain water heat recovery system that is field verified as specified in the Reference Appendix RA3.6.9.
 - iii. A gas or propane instantaneous water heater with an input of 200,000 Btu per hour or less and no storage tank.
- B. ~~For~~ Recirculation distribution systems serving individual dwelling units, only shall use demand recirculation systems with manual on/off control as specified in the Reference Appendix RA4.4.9 shall be used.
2. ~~For heat pump water heating systems serving multiple dwelling units, Domestic hot water systems serving multiple dwelling units shall meet the applicable requirements from A to F.~~
- A. For heat pump water-heating systems serving multiple dwelling units, the water heating system shall be installed according to the manufacturer design and installation guidelines and meet ~~the following requirements: i or ii, or meet the performance compliance requirements of Section 170.1:~~
- i. A system meeting the following requirements:
 - I. Use single-pass primary heat pump water heater. The hot water return from the recirculation loop shall connect to a recirculation loop tank and shall not directly connect to the primary heat pump water heater inlet or the primary thermal storage tanks.
 - II. The primary storage tank temperature setpoint shall be at least 135°F.
 - III. The fuel source for the recirculation loop tank shall be electricity. ~~if auxiliary heating is needed. The recirculation loop heater shall be capable of multi-pass water heating operation.~~
 - IV. ~~For systems with single pass primary heat pump water heater, the primary thermal storage tanks shall be piped in series if multiple tanks are used. For systems with multi-pass primary heat~~

~~pump water heater, the primary thermal storage tanks shall be piped in parallel if multiple tanks are used.~~

- v. The recirculation loop tank temperature setpoint shall be at least 10°F lower than the primary thermal storage tank temperature setpoint ~~such that hot water from the recirculation loop tank is used for the temperature maintenance load before engaging the recirculation loop tank heater.~~
- vi. The minimum heat pump water heater compressor cut-off temperature shall be equal to or lower than 40°F ambient air temperature.
- vii. Have a recirculation distribution system.

Exception to Section 170.2(d) ~~2G2A.vii~~: Buildings with eight or fewer dwelling units.

viii. Design documentation shall be provided in accordance with JA14.4.

ii. A system that meets requirement of NEEA Advanced Water Heating Specification for commercial HPWH system Tier 2 or higher.

- B. For gas or propane systems serving multiple dwelling units, a central water-heating system that includes the following components shall be installed:
 - i. For Climate Zones 1 through 9, gas service water-heating systems with a total installed gas water-heating input capacity of 1 MMBtu/h or greater shall have gas service water-heating equipment with a minimum thermal efficiency of 90 percent. Multiple units are allowed to meet this requirement with an input capacity-weighted average of at least 90 percent.
 - **Exception 1 to Section 170.2(d) ~~3A2Bi~~:** Individual gas water heaters with input capacity at or below 100,000 Btu/h shall not be included in the calculations of the total system input or total system efficiency.
 - **Exception 2 to Section 170.2(d) ~~3A2Bi~~:** If 25 percent of the annual water-heating requirement is provided by site-solar energy or site-recovered energy.
 - ii. A recirculation system.
 - **Exception to Section 170.2(d) ~~3B2Bii~~:** Buildings with eight or fewer dwelling units.

- iii. A solar water-heating system meeting the installation criteria specified in Reference Residential Appendix RA4 and with a minimum solar savings fraction of either ~~i or ii~~ i or II below:
 - i. A minimum solar savings fraction of 0.20 in Climate Zones 1 through 9 or a minimum solar savings fraction of 0.35 in Climate Zones 10 through 16; or
 - ii. A minimum solar savings fraction of 0.15 in Climate Zones 1 through 9 or a minimum solar savings fraction of 0.30 in Climate Zones 10 through 16. In addition, a drain water heat recovery system that is field verified as specified in the Reference Appendix RA3.6.9.
- C. A water-heating system serving multiple dwelling units determined by the Executive Director to use no more energy than the one specified in Subsection 1A,2A, or ~~32B~~ above.
- D. For central systems with hot water distribution piping serving multiple dwelling units, verify pipe sizing is in accordance with CPC Appendix M.
- E. Recirculation distribution systems serving multiple dwelling units shall meet the requirements in Section 110.3(c)2 and 110.3(c)5-4, ~~and shall be capable of automatically controlling the recirculation pump operation based on measurement of hot water demand and hot water return temperature.~~
- F. Central domestic hot water distribution systems with recirculation loop(s) serving multiple dwelling units shall install a mechanical or digital thermostatic master mixing valve on each distribution supply and return loop and meet the requirements specified in the Nonresidential and Multifamily Reference Appendix RA4.4.20.

11.3 Reference Appendices

11.3.1 RA2.2 Measures that Require Field Verification and Diagnostic Testing

Table RA2-1 describes the measures that require installer certification and HERS Rater field verification and diagnostic testing and identifies the protocol or test procedure in the Reference Residential Appendices that shall be used for completing installer and HERS Rater field verification and diagnostic testing.

**RA2-1 – SUMMARY OF MEASURES REQUIRING FIELD VERIFICATION AND
DIAGNOSTIC TESTING**

Measure Title	Description	Procedure(s)
Single Family DHW Measures		
Verified Pipe Insulation Credit (PIC-H)	Inspection to verify that all hot water piping in non-recirculating systems is insulated and that corners and tees are fully insulated. No piping should be visible due to insulation voids except for the last segment of piping that penetrate walls and delivers hot water to the sink, appliance, etc.	RA3.6.3
Verified Parallel Piping (PP-H)	Inspection that requires that the measured length of piping between the water heater and single central manifold does not exceed five feet	RA3.6.4
Verified Compact Hot Water Distribution System Expanded Credit (CHWDS-H-EX)	Field verification to ensure that the eligibility criteria specified in RA 3.6.5 are met.	RA3.6.5
Demand Recirculation: Manual Control (RDRmc-H)	Inspection to verify that all recirculating hot water piping is insulated, and that corners and tees are fully insulated. No piping should be visible due to insulation voids	RA3.6.6
Demand Recirculation: Sensor Control (RDRsc-H)	Inspection to verify that all recirculating hot water piping is insulated, and that corners and tees are fully insulated. No piping should be visible due to insulation voids.	RA3.6.7
Verified Drain Water Heat Recovery System (DWHR-H)	Inspection to verify that the DWHR unit(s) and installation configuration match the compliance document and the DWHR(s) is certified to the Commission to have met the requirements.	RA3.6,9
Multifamily DHW Heating Measures		
Multiple Recirculation Loop Design for DHW Systems Serving Multiple Dwelling Units	Inspection that a central DHW system serving a building with more than eight dwelling units has at least two recirculation loops, each serving roughly the same number of dwelling units. These recirculation loops may be connected to the same water heating	RA3.6.8

Measure Title	Description	Procedure(s)
	equipment or independent water heating equipment.	
Verified Drain Water Heat Recovery System (DWHR-H)	Inspection to verify that the DWHR unit(s) and installation configuration match the compliance document and the DWHR(s) is certified to the Commission to have met the requirements.	RA3.6.9
<u>Hot Water Pipe Insulation Verification</u>	<u>Inspection to verify that the hot water piping, fittings and appurtenances are continuously insulated per mandatory requirements.</u>	<u>RA3.6.10</u>

11.3.2 RA3.6 Field Verification of Water Heating Systems

RA3.6.10 Hot Water Pipe Insulation Verification

For central systems with hot water piping serving multiple dwelling units, heating plant and recirculation system piping insulation installation quality shall be field verified by a HERS rater. The HERS rater shall inspect the heating plant and horizontal supply header and return piping in accordance with mandatory requirements in Title 24 Part 6 section 160.4. The rater shall use a sampling approach that one in seven DHW recirculation pipe risers and associated branches be inspected to ensure pipe insulation has been installed with the following requirements:

- A. All piping for multifamily domestic hot water systems shall be insulated including the first 8 feet of inlet cold water piping to the heating plant. Insulation on the piping and appurtenances shall be continuous.
- B. All appurtenances at the heating plant, from a heating source to storage tank(s), or in between storage tanks and storage water heaters, and recirculation supply and return loop shall be insulated to code requirements.
 - a. Insulation thickness to be flush with pipe insulation or minimum 1"-thick if appurtenance is bulkier.
 - b. Removable and re-installable for maintenance or replacement.
- C. Pipe supports, hangers, and clamps shall be attached on the outside of rigid pipe insulation.
- D. All pipe insulation seams shall be sealed along the length of the pipe and between adjacent sections of insulation material.
- E. Insulation for pipe elbows shall be mitered, insulation for tees shall be notched, or tees and elbows may be pre-formed, or site fabricated with PVC covers.

- F. To ensure pipe insulation thickness requirements can be met without impeding the function of isolation valves, extended stem isolation valves shall be installed on hot water piping or where pipe insulation is required.

11.3.3 RA4.4 Water Heating Measures

RA4.4.3 ~~Reserved for future use~~ **Thermostatic Balancing Valve Installation**

To receive the thermostatic balancing valve credit, calculations shall be completed that demonstrate that the length of the return piping portion of the domestic hot water recirculation loop does not exceed 160 feet. If the domestic hot water has multiple recirculation pipe loops, the length of any hot water return pipe shall not exceed 160 feet to receive credit.

A variable speed circulation pump with pump differential pressure control shall be installed. The circulation pump design flow rate should be calculated to meet the design hot water return temperature based on the calculated distribution system heat losses and the design hot water supply temperature. The circulation pump specified should be the smallest pump required to meet the design flow rate as calculated and documented by the responsible person associated with the project.

Each thermostatic balancing valve shall be installed after the last fixture on the hot water supply riser it serves. As part of the installer's start-up procedure, the installer shall perform the following:

1. Close all fixtures in the domestic water system
2. Start the circulation pump at a constant speed, targeting the circulation pump design flow, and allow the system 60 minutes to warm up
3. Verify that the temperature at the last riser does not exceed 120 °F
4. If the temperature at the last riser exceeds 120 °F, adjust the pump speed down and repeat the procedure, allowing 30 minutes for warm up
5. Once the temperature at the last riser is equal to or less than 120 °F, record the pump differential pressure and set the pump into differential pressure control mode using the recorded differential pressure as the set point.

RA4.4.20 **Multiple Dwelling Units: Master Mixing Valves**

For central systems with hot water piping serving multiple dwelling units master mixing valves (MMV) shall meet the following minimum specification, installation, and startup requirements.

Minimum MMV specification requirements included on the plumbing plans shall be:

1. Manufacturer's installation and commissioning instructions and plumbing drawings.
2. MMV conforms to the American Society of Sanitation Engineers (ASSE) 1017-2009 standard, *Performance Requirements for Temperature Actuated Mixing Valves for Hot Water Distribution Systems*.
3. Water mixing parameters and associated values:
 - A. Input parameters
 - i. Recirculation pump flow rate
 - ii. Mixing valve outlet water temperature
 - iii. Recirculation return water temperature
 - iv. Mixing valve hot inlet water temperature
 - B. Calculated parameters
 - i. Percentage of water flow returning to cold side of MMV
 - ii. Percentage of water flow returning to hot side of MMV
 - C. Manufacturer's operating parameter
 - i. Maximum water mixing ratio

These input parameters shall be used to calculate percentage of water flow on cold side and hot side of MV during recirculation water flow only condition to determine if the water mixing ratio exceeds mixing capability of the specified master mixing valve. If the calculated water flow ratio to the MMV inlet exceeds manufacturer's recommendations for that valve, then the designer shall provide instructions to commission the balancing valve to eliminate temperature creep to mitigate scalding risk after periods of no water draw.

- Installation and startup of MMV by the installer shall meet manufacturer's instruction and meet the following minimum requirements:
 1. Minimum installation requirements are:
 - A. The MMV shall be installed on the central heating plant hot water supply outlet header leading to the recirculation loop.
 - B. Check valves installed on the recirculation return line and cold-water line to inlet cold connection of MMV and on recirculation return piping leading back to storage tank or water heater.
 - C. Isolation valves installed on the inlet cold water, inlet recirculation return, inlet hot and outlet connections to MMV and on recirculation return piping connection to storage tank or water heater.

- D. Balancing valve installed on the recirculation return piping to the water heater for MMVs that cannot 100% close the hot inlet port during operation.
 - E. Thermometers installed on the outlet of the MMV and on the recirculation return line next the water pump.
2. Minimum startup requirements are:
- A. Startup testing of MMV during recirculation only operation.
 - i. Close all hot fixtures in the domestic water system.
 - ii. Ensure that the water heater is operational and idling with storage tank plumbed to the mixing valve and meeting the hot inlet temperature specified in the plumbing plans.
 - iii. Start the recirculation pump and set mixed outlet temperature or setpoint temperature on the MMV. Start the circulation pump at the specified water flow rate and adjust as needed to meet recirculation return temperature specified in the plumbing plans.
 - iv. Let distribution system warm up and stabilize for 30 minutes and adjust mixing parameters as needed to realign with values in plumbing plans.
 - v. Let the recirculation pump operate for three hours without any water draws to ensure there is no temperature creep.
 - vi. If during or after the three-hour period the MMV outlet and return temperature stays elevated by greater than 2°F and doesn't return back to the specified temperature, then make necessary adjustments to the MMV. If temperature creep persists with mechanical MMV, adjust the balancing valve as necessary on the recirculation return line leading back to the water heater to ensure average MMV outlet temperature meets the specified temperature.
 - vii. If adjustments are made to MMV or balancing valve in Step vi, then repeat Step v.
 - B. Startup testing of MMV for a combination of recirculation and hot water draws.
 - i. Once the MMV is operational in a closed loop, make a water draw for 10 minutes using one of the following options:
 - A. With a shower operating at full flow at every: three dwelling units in a building with 15 or fewer dwelling units, five dwelling units in a building with 16 to 30 dwelling units, eight dwelling units in a building with 31 to 60 dwelling units, ten dwelling units in a building than 60 to 200

dwelling units, twenty dwelling units in a building with more than 200 dwelling units.

- B. The hot water valve on a hose bib, mop sink, or other fixture on the branch line or location on the hot water distribution line is opened to a draw volume of 1 gpm for every: three dwelling units in a building with 15 or fewer dwelling units, five dwelling units in a building with 16 to 30 dwelling units, eight dwelling units in a building with 31 to 60 dwelling units, ten dwelling units in a building than 60 to 200 dwelling units, twenty dwelling units in a building with more than 200 dwelling units.
- ii. Monitor recirculation return temperature on the thermometer during the 10-minute draw period and ensure design return water temperature is maintained at the specified temperature documented in the plumbing plans.
 - iii. If the recirculation return temperature falls more than 5°F below the specified temperature during the draw period, then adjust MMV setup to ensure compliance.

11.3.4 JA15 Requirements for Electric Ready Water Heating

JA15.1 Purpose and Scope

Joint Appendix JA15 provides sizing requirements, for electric ready infrastructure installed with gas or propane water heating systems to meet the requirement for electric readiness specified in Title 24, Part 6, Section 160.9(e)

JA15.2 Definitions

Reserved

JA15.3 Electric Ready Requirements

JA15.3.1 Heat Pump Space Requirements

The space reserved shall meet the following requirements:

- (a) If the input capacity of the gas water heating system is less than 200,000 BTU/HR, the minimum space reserved for the heat pump shall be 2.0 square feet per 10,000 Btu/ HR input of the gas or propane water heating system, and the minimum linear dimension of the space reserved shall be 48 linear inches.
- (b) If the input capacity of the gas water heating system is greater than or equal to 200,000 BTU/HR, the minimum space reserved for the heat pump shall be 3.6 square feet per 10,000 Btu/ HR input of the gas or propane water heating

system, and the minimum linear dimension of the space reserved shall be 84 linear inches.

JA15.3.2 Tank Space Requirements

The space reserved shall meet the following requirements:

- (a) If the input capacity of the gas water heating system is less than 200,000 BTU/HR, the minimum space reserved for the storage and temperature maintenance tanks shall be 4.4 square feet per 10,000 Btu/HR input of the gas or propane water heating system.
- (b) If the input capacity of the gas water heating system is greater than or equal to 200,000 BTU/HR, the minimum physical space reserved for the storage and temperature maintenance tanks shall be 3.1 square feet per 10,000 Btu/HR input of the gas or propane water heating system.

JA15.3.3 Reserved Pathway and Penetrations through the Building Envelope for Ventilation

The reserved pathway and penetrations through the building envelope shall meet the following requirements:

- (a) If the input capacity of the gas water heating system is less than 200,000 BTU/HR, the minimum air flow rate shall be 70 CFM per 10,000 Btu/HR input of the gas or propane water heating system and the total external static pressure drop of ductwork and louvers shall not exceed 0.17" when the future heat pump water heater is installed.
- (b) If the input capacity of the gas water heating system is greater than or equal to 200,000 BTU/HR, the minimum air flow rate shall be 420 CFM per 10,000 Btu/HR input of the gas or propane water heating system and the total external static pressure drop of ductwork and louvers shall not exceed 0.17" when the future heat pump water heater is installed.

JA15.3.4 Condensate Drainage Piping Requirements

The condensate drainage piping shall meet the following requirements:

- (a) If the input capacity of the gas water heating system is less than 200,000 BTU/HR, condensate drainage shall be sized for 0.2 tons of refrigeration capacity per 10,000 Btu/HR input.
- (b) If the input capacity of the gas water heating system is greater than or equal to 200,000 BTU/HR, condensate drainage shall be sized for 0.7 tons of refrigeration capacity per 10,000 Btu/HR input.

JA15.3.5 Electrical Requirements

The electrical system serving the heat pump shall meet the following requirements:

- iv. If the input capacity of the gas water heating system is less than 200,000 BTU/HR, provide 0.1 kVA per 10,000 Btu/HR input.
- v. If the input capacity of the gas water heating system is greater than or equal to 200,000 BTU/HR, provide 1.1 kVA per 10,000 Btu/HR input.

The electrical system serving the temperature maintenance tank shall meet the following requirements:

1. If the input capacity of the gas water heating system is less than 200,000 BTU/HR, provide 1.0 kVA per 10,000 Btu/HR input.

If the input capacity of the gas water heating system is greater than or equal to 200,000 BTU/HR, provide 0.6 kVA per 10,000 Btu/HR input.

11.4 ACM Reference Manual

11.4.1 CPC Appendix M, Pipe Insulation Enhancement and Require Balancing Valve

Nonresidential and Multifamily Alternative Calculation Method Reference Manual

1.1 Miscellaneous Energy Uses

The *Nonresidential and Multifamily Alternative Calculation Method (ACM) Reference Manual* explains the requirements for approval of nonresidential and multifamily Title 24 compliance software in California. Approved compliance software is used to demonstrate minimum compliance with the *Building Energy Efficiency Standards* (Energy Code), CALGreen, or any metric approved by the California Energy Commission (CEC). Definitions and terms in this manual may be found in the 2022 Energy Code. The procedures and processes described in this manual are designed to provide consistency and accuracy while preserving integrity of compliance. This manual addresses compliance software for nonresidential buildings, hotels, motels, and multifamily buildings as outlined in Title 24, Part 6, Subchapter 5, §140.1, and Subchapter 11, §170.1. A separate ACM reference manual applies to single family residential buildings. The approval process for nonresidential compliance software programs is specified in Title 24, Part 1, Section 10-101 through Section 10-110 of the California Code of Regulations.

5 Nonresidential Building Descriptors Reference

5.9 Miscellaneous Energy Uses

Miscellaneous energy uses are defined as those that may be treated separately since they have little or no interaction with the conditioned thermal zones or the HVAC systems that serve them.

Recirculation Systems

This chapter describes the building descriptors for hot water recirculation systems. For nonresidential application, recirculation systems are not modeled. For multifamily, the standard design has a recirculation system when the proposed design does.

Recirculating systems shall follow the rules set forth in Appendix [EB: Water Heating Calculation Method](#) of the *Residential ACM Reference Manual*.

Note from Statewide CASE Team: Appendix B: Water Heating Calculation Method includes ACM rules for multifamily DHW recirculation systems. This appendix has resided in the Residential ACM Reference Manual and needs to be moved to the Nonresidential and Multifamily Alternative Calculation Method Reference Manual.

6 Multifamily Building Descriptors Reference

6.1 Standard Design

For multifamily buildings, the standard design building, from which the energy budget is established, is in the same location and has the same floor area, volume, and configuration as the proposed design. For additions and alterations, the standard design shall have the same wall areas and orientations as the proposed building. The details are described below.

The *energy budget* for the multifamily standard design is the energy that would be used by a building similar to the proposed design if the proposed building met the requirements of the prescriptive standards. The compliance software generates the standard design automatically, based on fixed and restricted inputs and assumptions. Custom energy budget generation shall not be accessible to program users for modification when the program is used for compliance or when the program generates compliance forms.

The basis of the standard design is prescriptive requirements from §170.2 of the Energy Code. Prescriptive requirements vary by climate zone. Reference Appendices, Joint Appendix JA2, Table 2-1, contains the 16 California climate zones and representative cities. The climate zone is based on the zip code for the proposed building, as documented in JA2.1.1.

The following chapters present the details of how the proposed design and standard design are determined. For many modeling assumptions, the standard design is the same as the proposed design. When a building has special features, for which the CEC has established alternate modeling assumptions, the standard design features would differ from the proposed design, so the building receives appropriate credit for its

efficiency. When measures require verification by a Home Energy Rating System (HERS) rater, installer test and report, or are designated as a *special feature*, the specific requirement is listed on the LMCC or NRCC.

6.2 Proposed Design

The multifamily building configuration is defined by the user through entries that include floor areas, wall areas, roof and ceiling areas, fenestration (which includes skylights), and door areas, the performance characteristics such as U-factors, R-values, solar heat gain coefficient (SHGC), solar reflectance, and information about the orientation and tilt is required for roofs, and other elements, and end use energy use such as HVAC, lighting, and DHW. Details about any solar generation systems and battery storage are also defined. The user entries for all these building elements are consistent with the actual building design and configuration. If the compliance software models the specific geometry of the building by using a coordinate system or graphic entry technique, the data generated are consistent with the actual building design and configuration.

6.11 Domestic Hot Water

Water heating energy use is based on the number of dwelling units, number of bedrooms, fuel type, distribution system, water heater type, and conditioned floor area. Detailed calculation information is included in Appendix B: [Water Heating Calculation Method of the Residential ACM Reference Manual](#).

PROPOSED DESIGN

The water heating system is defined by the heater type (gas, electric resistance, or heat pump), tank type, dwelling-unit distribution type, efficiency (either UEF or recovery efficiency with the standby loss), tank volume, exterior insulation R-value (only for indirect), rated input, and tank location (for electric resistance and heat pump water heater only).

Unitary heat pump water heaters are defined by energy factor, volume, and tank location or, for Northwest Energy Efficiency Alliance (NEEA) rated heat pumps, by selecting the specific heater brand, model, and tank location.

Water heater and tank types include:

- Consumer storage: $\leq 75,000$ Btu/h gas/propane, ≤ 12 kW electric, or ≤ 24 amps heat pump, rated with UEF.
- Consumer instantaneous: $\leq 200,000$ Btu/h gas or propane, or ≤ 12 kW electric. An instantaneous water heater is a water heater with an input rating of $\geq 4,000$ Btu/h/gallon of stored water, rated with a UEF.
- Residential-duty commercial storage: $> 75,000$ Btu/h, $\leq 105,000$ Btu/h gas/propane, ≤ 12 kW electric, ≤ 24 amps heat pump, and rated storage volume < 120 gallons, rated with a UEF.

- Residential-duty commercial instantaneous: $\leq 200,000$ Btu/h gas/propane, ≤ 58.6 kW electric, rated storage volume ≤ 2 gallons, rated with a UEF.
- Commercial storage: $> 75,000$ Btu/h gas/propane, $>105,000$ Btu/h oil, or > 12 kW electric, rated with thermal efficiency and standby loss.
- Commercial instantaneous: $>200,000$ Btu/h gas/propane, > 12 kW electric. Instantaneous water heater is a water heater with an input rating of $\geq 4,000$ Btu/h per gallon of stored water, rated with thermal efficiency.
- Unitary heat pump water heater: ≤ 24 amps NEEA rating or rated with UEF.
- Mini-tank (modeled only in conjunction with an instantaneous gas water heater): a small electric storage buffering tank that may be installed downstream of an instantaneous gas water heater to mitigate delivered water temperatures (e.g., cold water sandwich effect). If the standby loss of this aftermarket tank is not listed in the [CEC appliance database](#), a standby loss of 35 W must be assumed.
- Indirect: a tank with no heating element or combustion device used in combination with a boiler or other device serving as the heating element.
- Boiler: a water boiler that supplies hot water, rated with thermal efficiency or AFUE.

Heater element type includes:

- Electric resistance.
- Gas.
- Heat pump.

Dwelling unit distribution system types for systems serving individual dwelling units include:

- Standard (all distribution pipes insulated).
- Point of use.
- Central parallel piping.
- Recirculation with nondemand control (continuous pumping).
- Recirculation with demand control, push button.
- Recirculation with demand control, occupancy/motion sensor.
- HERS-required pipe insulation, all lines.
- HERS-required central parallel piping.
- HERS-required recirculation, demand control, push button.
- HERS-required recirculation with demand control, occupancy/motion sensor.

When a multifamily building has central water heating, both a dwelling unit and a central system distribution type must be specified. Dwelling unit distribution types for this case include:

7. Standard (all distribution pipes insulated).
8. HERS required pipe insulation, all lines.

Multifamily central hot water heating central system distribution types include:

- No loops or recirculation system pump.
- Recirculation with no control (continuous pumping).

Some distribution systems have an option to increase the amount of credit received if the option for HERS verification is selected. See Appendix B for credit and *Reference Appendices, Residential Appendix Table RA2-1* for a summary of inspection requirements.

Pipe Sizing

CPC Appendix M is the standard pipe sizing methodology used for all distribution piping. If CPC Appendix A methodology is followed, then an energy compliance penalty is applied based on Appendix B Table B-6.

6.11.3 Multiple Dwelling Units – Central Water Heating

The energy performance of central water heating systems is determined by the primary heating equipment, primary heating storage volume, location, secondary heating equipment, secondary heating storage volume, set point controls, and the way in which the components are plumbed.

Recirculating system. If the central water-heating system has recirculation loops, the standard design includes a recirculation system with no controls, a **thermostatic master mixing valve** and one recirculation loop.

Master Mixing Valve

Thermostatic master mixing valve is the standard design used for central water heating systems. If a mechanical master mixing valve (MMMV) is installed at the hot water outlet pipe leading from the heating plant to the centralized distribution system with a fixed 1.0 DHW system correction factor for HPWH systems in Table 43 and Gas systems in Table 44, then a hot water system daily energy compliance penalty or credit is not incurred. There is a DHW system energy penalty if no MMV is installed. This is dependent on the heating plant characteristics based on the heating source, heater and storage tank configuration, and heating plant hot water outlet and recirculation return temperature.

Table 43. HPWH System Correction Factor

HPWH Systems	Standard Design: Digital MMV Correction Factor	Standard Design: Mechanical MMV Correction Factor	Proposed Design: No MMV Correction Factor
Multi-Pass Integrated HPWH			
1°F ≤ ΔT (Outlet - Return) ≤ 7°F	1	1	1.15
7°F < ΔT	1	1	1.12
Single-Pass Primary (CO2 refrigerant) HP with Recirculation Return to Primary Tank			
1°F ≤ ΔT ≤ 7°F	0.96	1	1.14
7°F < ΔT	1.00	1	1.09
Single-Pass Primary (not CO2 refrigerant) HP with Recirculation Return to Primary Tank			
1°F ≤ ΔT ≤ 7°F	0.96	1	1.14
7°F < ΔT	1.00	1	1.09
Multi-Pass Primary HP with Recirculation Return to Primary Tank			
1°F ≤ ΔT ≤ 7°F	0.96	1	1.15
7°F < ΔT	0.98	1	1.12
Single-Pass Primary HP with Recirculation Return to Series ERWH			
1°F ≤ ΔT ≤ 7°F	0.96	1	1.08
7°F < ΔT	0.99	1	1.05
Single-Pass Primary HP with Recirculation Return to Secondary (CO2 refrigerant) Parallel HPWH			
1°F ≤ ΔT ≤ 7°F	0.96	1	1.10
7°F < ΔT	0.99	1	1.06
Single-Pass Primary HP with Recirculation Return to Secondary (not CO2 refrigerant) Parallel HPWH			
1°F ≤ ΔT ≤ 7°F	0.96	1	1.10
7°F < ΔT	0.99	1	1.06

Table 44. Gas-Fired Water Heating System Correction Factor

Gas Systems	Standard Design: Digital MMV Correction Factor	Standard Design: Mechanical MMV Correction Factor	Proposed Design: No MMV Correction Factor
Integrated Gas Atmospheric WH			

1°F ≤ ΔT (Outlet - Return) ≤ 7°F	1	1	1.03
7°F < ΔT	1	1	1.03
Integrated Gas Condensing WH			
1°F ≤ ΔT ≤ 7°F	1	1	1.03
7°F < ΔT	1	1	1.03
Multi-Pass Primary Gas Atmospheric WH with Recirculation Return to Primary Tank			
1°F ≤ ΔT ≤ 7°F	1	1	1.03
7°F < ΔT	1	1	1.03
Multi-Pass Primary Gas Condensing WH with Recirculation Return to Primary Tank			
1°F ≤ ΔT ≤ 7°F	1	1	1.03
7°F < ΔT	1	1	1.03

2022 Residential Alternative Calculation Method Reference Manual

Appendix B: Water Heating Calculation Method

B1. Purpose and Scope

This appendix documents the methods and assumptions used for calculating the hourly energy use for residential water heating systems for the proposed design and the standard design. The hourly fuel and electricity energy use for water heating would be combined with hourly space heating and cooling energy use to come up with the hourly total fuel and electricity energy use to be factored by the hourly time-dependent valuation (TDV) energy multiplier. The calculation procedure applies to low-rise single family, low-rise multifamily, and high-rise residential.

Calculations are described below for gas and electric water heaters. The internal water heater modeling is performed within the California Simulation Engine (CSE). The compliance modeling rules documented here are implemented in the (California Building Energy Code Compliance) CBECC-Res ruleset and determine the input values passed to CSE.

When buildings have multiple water heaters, the hourly total water heating energy use is the hourly water heating energy use summed over all water heating systems, all water heaters, and all dwelling units being modeled.

B4. Hourly Adjusted Recovery Load

The hourly-adjusted recovery load for the kth water heating system is calculated as:

$$HARL_k = HSEU_k + HRDL_k + \sum_l^{NL_k} HJL_l + HPPL_k \quad \text{Equation 3}$$

where

HARL_k – Hourly adjusted recovery load (Btu)

HSEU_k – Hourly standard end use at all use points (Btu), see Equation 4

HRDL_k – Hourly recirculation distribution loss (Btu), see Equation 14

15; HRDL_k is nonzero only for multifamily central water heating systems.

NL_k – Number of unfired or indirectly fired storage tanks in the kth system

HJL_l – Tank surface losses of the lth unfired tank of the kth system (Btu), see Equation 4345

HPPL_k – Hourly water heating plant pipe heat loss (Btu), see Equation 45.

Equation 4 calculates the hourly standard end use (HSEU). The heat content of the water delivered at the fixture is the draw volume in gallons (GPH) times the temperature rise DT (difference between the cold-water inlet temperature and the hot water supply temperature) times the heat required to elevate a gallon of water 1°F (the 8.345 constant).

$$HSEU_k = 8.345 \times GPH_k \times (T_s - T_{inlet}) \quad \text{Equation 4}$$

Where

HSEU_k – Hourly standard end use (Btu)

GPH_k – Hourly hot water consumption (gallons) from Equation 2

Equation 5 calculates the distribution loss multiplier (DLM), which combines the standard distribution loss multiplier (SDLM), which depends on the floor area of the dwelling unit and the distribution system multiplier (DSM).

$$DLM_k = 1 + (SDLM_k - 1) \times DSM_k \quad \text{Equation 5}$$

Where

DLM_k – Distribution loss multiplier (unitless)

SDLM_k – Standard distribution loss multiplier (unitless). See Equation 6

DSM_k – Distribution system multiplier (unitless). See Section Distribution Losses Withing the Dwelling Unit. Several relationships depend on CFA_k, the floor area served (see below).

Equation 6 calculates the standard distribution loss multiplier (SDLM) based on dwelling unit floor area. In Equation 6Equation, that floor area CFAU_k is capped at 2500 ft².

Without that limit, Equation 6 produces unrealistic SDLM_k values for large floor areas.

$$SDLM_k = 1.0032 = 0.0001864 \times CFAU_k - 0.0000002165 \times CFAU_k^2 \quad \text{Equation 6}$$

Where

SDLM_k – Standard distribution loss multiplier (unitless).

CFAU_k – Dwelling unit conditioned floor area (ft²) served by the kth system, calculated using methods specified in Equation 7.

Single dwelling unit,

$$CFAU_k = CFA/NK$$

For multiple dwelling units served by a central system:

$$CFAU_k = \frac{\sum_{\text{all units served by system k}} CFA_i}{N_{\text{unit}_k}}$$

Alternatively, if the system-to-unit relationships not known:

$$CFAU_k = \frac{\sum_{\text{all units served by any central system}} CFA_i}{\text{Number of units served by any central system}} \quad \text{Equation 7}$$

Method WH-CFAU

Note: “Method” designations are invariant tags that facilitate cross-references from comments in implementation code.

When a water heating system has more than one water heater, the total system load is assumed to be shared equally by each water heater, as shown in Equation 8.

$$HARL_j = \frac{HARL_k}{NWH_k} \quad \text{Equation 8}$$

Where

HARL_j – Hourly adjusted recovery load for the jth water heater of the kth system (Btu)

HARL_k – Hourly adjusted total recovery load for the kth system (Btu)

NWH_k – The number of water heaters in the kth system

B5. Hourly Distribution Loss for Central Water Heating Systems

This section is applicable to the DHW system Types 3 and 4, as defined in B1. The distribution losses accounted for in the distribution loss multiplier (DLM), Equation 5, reflect distribution heat loss within each dwelling unit. Additional distribution losses occur outside dwelling units and include losses from recirculation loop pipes and branch piping feeding dwelling units. The hourly values of these losses, HRDL, shall be calculated according to Equation 17. Compliance software shall provide input for specifying recirculation system designs and controls according to the following algorithms.

$$HRDL_k = NLoop_k \times HRLL_k + HRBL_k \quad \text{Equation 14}$$

Where

HRDL_k – Hourly central system distribution loss for kth system (Btu).

HRLL_k – Hourly recirculation loop pipe heat loss (Btu). This component is only applicable to system Type 4, see Equation 15

HRBL_k – Hourly recirculation branch pipe heat loss (Btu), see Equation 23 ~~NLoop_k~~

NLoop_k – Number of recirculation loops in water heating system k; this component is only applicable to system Type 4, see Section Drain Water Heat Recovery

A recirculation loop usually includes multiple pipe sections, not necessarily having the same diameter, that are exposed to different ambient conditions. The compliance software shall provide input entries for up to six pipe sections, with three sections for supply piping and three sections for return piping for users to describe the configurations of the recirculation loop. For each of the six pipe sections, input entries shall include pipe diameter (inch), pipe length (ft), and ambient conditions. Ambient condition input shall include three options: outside air, underground, conditioned or semi conditioned air. Modeling rules for dealing with recirculation loop designs are provided in Section Drain Water Heat Recovery.

Outside air includes crawl spaces, unconditioned garages, unconditioned equipment rooms, as well as the actual outside air. Solar radiation gains are not included in the calculation because the effect of radiation gains is relatively minimal compared to other effects. Furthermore, the differences in solar gains for the various conditions (for example, extra insulation vs. minimum insulation) are even less significant.

The ground condition includes any portion of the distribution piping that is underground, including that in or under a slab. Insulation in contact with the ground must meet all the requirements of Section 150.0(j), Part 6, of Title 24.

The losses to conditioned or semi conditioned air include losses from any distribution system piping that is in an attic space, within walls (interior, exterior, or between conditioned and unconditioned spaces), within chases on the interior of the building, or within horizontal spaces between or above conditioned spaces. It does not include the pipes within the residence. The distribution piping stops at the point where it first meets the boundaries of the dwelling unit.

Hourly Recirculation Loop Pipe Heat Loss Calculation

Hourly recirculation loop pipe heat loss (HRL_{Lk}) is the hourly heat loss from all six pipe sections. There are two pipe heat loss modes — pipe heat loss with nonzero water flow (PLWF) and pipe heat loss without hot water flow (PLCD). The latter happens when the recirculation pump is turned off by a control system and there are no hot water draw flows, such as in recirculation return pipes.

Compliance software shall provide four options of recirculation system controls listed in Table B-3 or Table B-4. A proposed design shall select a control type from one of the four options. The standard design shall use demand control.

Table B-3. Recirculation Loop Supply Temperature and Pump Operation Schedule (With No Control or Demand Control)

Hour	No Control Temperature	No Control Input for SCH _{k,m}	Demand Control Temperature	Demand Control Input for SCH _{k,m}
1 through 24	130	1	130	0.2

Source: California Energy Commission

Table B-4. Recirculation Loop Supply Temperature and Pump Operation Schedule (With Temperature Modulation Control)

Hour	Without Continuous Monitoring Temperature	Without Continuous Monitoring Input for SCH _{k,m}	With Continuous Monitoring Temperature	With Continuous Monitoring Input for SCH _{k,m}
1 through 5	120	1	115	1
6	125	1	120	1
7 through 23	130	1	125	1
24	125	1	120	1

Source: California Energy Commission

Pipe heat loss modes are determined by recirculation control schedules and hot water draw schedules. For each pipe section, hourly pipe heat loss is the sum of heat loss from the two heat loss modes.

Hourly heat loss for the whole recirculation loop (HRL_k) is the heat loss from the six pipe sections, according to the following equation:

$$HRL_k = \sum_n [PLWF_n + PLCD_n] \quad \text{Equation 15}$$

Where

PLWF_n – Hourly pipe heat loss with non-zero water flow (Btu/hr), see Equation 16

PLCD_n – Hourly pipe heat loss without water flow (Btu/hr), see Equation 21

n – Recirculation pipe section index, 1 through 6

$$PLWF_n = Flow_n \times (1 - f_{noflow,n}) \times \rho \times C_p \times (T_{n,in} - T_{n,out}) \quad \text{Equation 16}$$

Where

Flow_n – Flow_{recirc} + Flow_{n,draw} (gph), assuming

$Flow_{recirc}$ – Hourly recirculation flow (gph). ~~is assumed to be 360 gallons based on the assumption that the recirculation flow rate is 6 gpm.~~ $Flow_{recirc}$ shall be calculated as $N_{unit,k} / N_{floor,k} \times 0.5 \times 60 \times f_{BV}$. f_{BV} is the balancing valve and variable speed recirculation pump recirculation flow reduction factor. For the standard design, $f_{BV} = 1.0$. For the proposed design, if the recirculation system meets all the criteria of RA 4.4.3, $f_{BV} = 0.6$. Otherwise, $f_{BV} = 1.0$.

$Flow_{n,draw}$ – Average hourly hot water draw flow (gph); for supply sections, $n=1, 2, \text{ or } 3$, $Flow_{n,draw} = GPH_k / N_{Loop,k}$; for return pipes, $n=4, 5, \text{ and } 6$, $Flow_{n,draw} = 0$

$f_{noflow,n}$ – Fraction of the hour for pipe section n to have zero water flow, see Equation 17

ρ – Density of water, 8.345 (lb/gal)

C_p – Specific heat of water, 1 (Btu/lb-°F)

$T_{n,in}$ – Input temperature of section n (°F); for the first section ($n=1$), $T_{1,in}$ shall be determined based on Table B-2. The control schedule of the proposed design shall be based on user input. The standard design is demand control. For other sections, input temperature is the same as the output temperature the proceeding pipe section, $T_{n,in} = T_{n-1,out}$

$T_{n,out}$ – Output temperature of section n (°F), see Equation 18

$$f_{noflow,n} = (1 - SCH_{k,m}) \times NoDraw_n \quad \text{Equation 17}$$

Where

$NoDraw_n$ – Fraction of the hour that is assumed to have no hot water draw flow for pipe section n ; $NoDraw_1 = 0.2$, $NoDraw_2 = 0.4$, $NoDraw_3 = 0.6$, $NoDraw_4 = NoDraw_5 = NoDraw_6 = 1$

$SCH_{k,m}$ – Recirculation pump operation schedule, representing the fraction of the hour that the recirculation pump is turned off, see Table B-2 or Table B-3. $SCH_{k,m}$ for the proposed design shall be based on proposed recirculation system controls. Recirculation system control for the standard design is demand control.

$$T_{out,n} = T_{amb,n} + (T_{in,n} - T_{amb,n}) \times e^{-\frac{UA_n}{\rho C_p Flow_n}} \quad \text{Equation 18}$$

Where

$T_{Amb,n}$ – Ambient temperature of section n (°F), which can be outside air, underground, conditioned, or semi-conditioned air. Outside air temperatures shall be the dry-bulb temperature from the weather file. Underground temperatures shall be obtained from Equation 11. Hourly conditioned air temperatures shall be the same as conditioned space temperature. For the proposed design, $T_{amb,n}$ options shall be based on user input. The standard design assumes all pipes are in conditioned air.

UA_n – Heat loss rate of section n (Btu/hr-°F), see Equation 19

$$UA_n = Len_n \times \min(U_{bare,n}, f_{UA} \times U_{insul,n})$$

Equation 19

Where

Len_n – Section n pipe length (ft); for the proposed design, use user input; for the standard design, see Equation 30

$U_{bare,n}$, $U_{insul,n}$ – Loss rates for bare (uninsulated) and insulated pipe (Btu/hr-ft-°F), evaluated using Equation 20 with section-specific values, as follows:

f_{UA} – Correction factor to reflect imperfect insulation, insulation material degradation over time, and additional heat transfer through connected branch pipes that is not reflected in branch loss calculation. For the standard design, $f_{UA} = 2.0$. For proposed designs, $f_{UA} = 2.0$ if pipe insulation installation is verified per Residential Reference Appendix RA 2.2; otherwise, $f_{UA} = 2.4$.

Dia_n – Section n pipe nominal diameter (inch); for the proposed design, use user input; for the standard design, see Equation 31.

$Thick_n$ – Pipe insulation minimum thickness (inch) as defined in the Title 24 Section 120.3, TABLE 120.3-A for service hot water system

$Cond_n$ – Insulation conductivity shall be assumed = 0.26 (Btu inch/h-sf·F)

h_n – Section n combined convective/radiant surface coefficient (Btu/hr-ft²-F) assumed = 1.5

~~f_{UA} = Correction factor to reflect imperfect insulation, insulation material degradation over time, and additional heat transfer through connected branch pipes that is not reflected in branch loss calculation. It is assumed to be 2.0.~~

Equation 20 defines general relationships used to calculate heat loss rates for both loop and branches using appropriate parameters.

$$Dia_o = Dia + 0.125$$

$$U_{bare} = h \times \pi \times \frac{Dia_o}{12}$$

$$Dia_x = Dia_o + 2 \times Thick$$

$$U_{insul} = \frac{\pi}{\frac{\ln\left(\frac{Dia_x}{Dia_o}\right)}{\frac{2 \times Cond}{12}} + \frac{12}{h \times Dia_x}}$$

Equation 20

Where

Dia – Pipe nominal size (in)

Dia_o – Pipe outside diameter (in)

Dia_x – Pipe + insulation outside diameter (in)

Thick – Pipe insulation thickness (in)

Cond – Insulation conductivity (Btu in/hr-ft²- °F)

h – Combined convective/radiant surface coefficient (Btu/hr-ft²- °F)

Pipe heat loss without water flow shall be calculated according to the following equations:

$$PLCD_n = Vol_n \times \rho \times C_p \times (T_{n,start} - T_{n,end})$$

Equation 21

Where

Vol_n – Volume of section n (gal) is calculated as $7.48 \times \pi \times \left(\frac{Dia_o}{24}\right)^2 \times Len_n$ where 7.48 is the volumetric unit conversion factor from cubic feet to gallons. Note that the volume of the pipe wall is included to approximate the heat capacity of the pipe material.

T_{n,start} – Average pipe temperature (°F) of pipe section n at the beginning of the hour. It is the average of T_{n,in} and T_{n,out} calculated according to Equation 19 and associated procedures.

T_{n,end} – Average pipe temperature (°F) of pipe section n at the end of pipe cool down, see Equation 22

$$T_{n,end} = T_{amb,n} + (T_{n,start} - T_{amb,n}) \times e^{-\frac{UA_n \times f_{no\ flow,n}}{Vol_n \times \rho \times C_p}}$$

Equation 22

Equation 23 calculates average pipe temperature after cooling down, so the pipe heat loss calculated by Equation 22 is for pipe with zero flow for fraction f_{no flow,n} of an hour. Recirculation pumps are usually turned off for less than an hour and there could be hot water draw flows in the pipe. As a result, recirculation pipes usually cool down for less than an hour. The factor f_{no flow,n} calculated according to Equation 18 is used to reflect this effect in Equation 23.

Recirculation System Plumbing Designs

~~A recirculation system can have one or several recirculation loops. Each recirculation loop consists of many pipe sections, which are connected in sequence to form a loop. Each pipe section could have different pipe diameter, length, and location. The compliance software shall use six pipe sections, with three supply pipe sections and three return pipe sections, to represent a recirculation loop. When multiple recirculation loops exist, all recirculation loops are assumed identical. The compliance software shall provide default and standard recirculation system designs based on building geometry according to the procedures described in the following sections. The default design reflects typical recirculation loop design practices. The standards design is based on one or two loops and is used to set recirculation loop heat loss budget.~~

The first step of establishing recirculation system designs is determining the number of recirculation loops, N_{loop_k} , in water heating system k . The standard design has one recirculation loop, $N_{loop_k}=1$, when $N_{unit} \leq 8$, or two recirculation loops, $N_{loop_k}=2$ for buildings with $N_{unit} > 8$. The proposed design is allowed to specify more than one loop only if the design is verified by a HERS Rater. Otherwise, the proposed design can only be specified to have one recirculation loop.

The standard and default recirculation loop designs are based on characteristics of the proposed building. There could be many possibilities of building shapes and dwelling unit configurations, which would determine recirculation loop pipe routings. Without requiring users to provide detailed dwelling unit configuration information, the compliance software shall assume the proposed buildings to have same dwelling units on each floor and each floor to have a corridor with dwelling units on both sides. Recirculation loops start from the mechanical room (located on the top floor), go vertically down to the middle floor, loop horizontally in the corridor ceiling to reach the dwelling units on both ends of the building, then go vertically up back to the mechanical room. At each dwelling unit on the middle floor, vertical branch pipes, connected to the recirculation loop supply pipe, are used to provide hot water connection to dwelling units on other floors above and below.

Both the standard and default recirculation loop designs are assumed to have equal length of supply sections and return sections. The first section is from the mechanical room to the middle floor. The second section serves first half branches connected to the loop, and the third section serves the rest of the branches. The first and second sections have the same pipe diameter. Pipe size for the third section is reduced since fewer dwelling units are served. Return sections match with the corresponding supply pipes in pipe length and location. All return sections have the same diameter. For the standard and default designs, mechanical room is optimally located so that only vertical piping is needed between the mechanical room and the recirculation pipes located on the middle floor. Pipe sizes are determined based on the number of dwelling units served by the loop, following the 2009 Uniform Plumbing Code (UPC) pipe sizing guidelines. The detailed recirculation loop configurations are calculated as follows:

— Pipe length in the mechanical room (ft): $L_{mech}=8$

— Height of each floor (ft): H_{floor} =user input floor to floor height (ft)

— Length of each dwelling unit (ft): $L_{unit} = \sqrt{CFAU_k}$ (see Equation 7)

A recirculation system consists of multiple pipes, which are connected in sequence to form a loop. Within a recirculation loop, there can be multiple parallel flow paths formed by riser pipes between supply and return pipes. The compliance software shall use six pipe sections, with three supply pipe sections and three return pipe sections, to represent a recirculation loop. The compliance software shall model recirculation

system according to the piping design described in the following sections. This piping design is based on typical recirculation system piping layout practices and pipe sizing methods defined in California Plumbing Code Appendix A and Appendix M.

Supply pipes start from the water heating plant master mixing valve outlet located on the first floor then routed to the corridor ceiling. Supply pipes run horizontally to each end of the building. Horizontal riser pipes connected to supply pipes bring hot water to each first-floor dwelling unit. Each horizontal riser is connected to vertical riser pipes to bring hot water to dwelling units on upper floors. In the ceiling of the top floor, vertical riser pipes are connected to horizontal riser pipes, which bring hot water to recirculation return pipes in the corridor ceiling. A vertical recirculation return pipe brings hot water down to the heating plant on the first floor to complete the loop. This recirculation loop design uses risers to bring hot water to each dwelling unit and, therefore, branch pipes for connecting riser pipes and pipes leading to individual hot water fixtures are relatively short.

All supply pipes and the bottom half of riser pipes are converted into three sections of supply pipes in the default recirculation loop design. All return pipes and the top half of riser pipes are converted into three sections of return pipes in the default recirculation loop design. The first pipe section includes pipes from the water heating plant master mixing valve outlet to the first riser. The second pipe section includes supply pipes for the first half risers and the bottom half of these first half risers. The third pipe section includes the remaining supply pipes and the bottom half of the second half risers. The first pipe section represents pipes for supplying the whole building and, therefore, has the largest pipe diameter. The second section has a smaller pipe diameter because it represents the supply pipes and riser pipes with smaller pipe diameters. Pipe diameter for the third section is smallest because it represents pipes serving the fewest dwelling units. Return pipe sections (4, 5, and 6) represent return pipes and the top half of riser pipes in a similar way as supply pipe sections. Each return pipe section has the same pipe length as the corresponding supply pipe section. Pipe diameters for all return pipe sections are 0.75 inch.

For both the standard and proposed design, pipe section lengths are calculated as follows:

Length of recirculation pipe sections (ft):

$$Len_1 = Len_6 = L_{mech} + H_{floor} \times \frac{N_{floor}}{2}$$

$$Len_1 = Len_6 = 0.3 \times N_{unit_k} + 4$$

Equation 30

$$Len_2 = Len_3 = Len_4 = Len_5 = L_{unit} \times \frac{N_{unit_k}}{4 \times N_{loop_k} \times N_{floor}}$$

$$Len_2 = Len_3 = Len_4 = Len_5 = 5.5 \times N_{unit_k}$$

Equation 3031

Method WH-LOOPLEN

Pipe diameters for recirculation loop supply sections depend on the number of dwelling units being served ~~and return section diameters depend only on building type~~, as follows:

~~Dia₁, Dia₂, and Dia₃: derived from Table B-6, based on Nunit₁, Nunit₂, and Nunit₃. The standard design shall use values listed under California Plumbing Code Appendix M Pipe Sizing Method in Table B-6. Proposed designs shall use the same values as the standard design if pipes are sized using California Plumbing Code Appendix M Pipe Sizing Method. Otherwise, values listed under California Plumbing Code Appendix A Pipe Sizing Method shall be used.~~

~~Dia₄ = Dia₅ = Dia₆ = 0.75 in for low-rise multifamily building and hotel/motel less than four stories~~

~~Dia₄ = Dia₅ = Dia₆ = 1.0 in for high-rise multifamily and hotel/motel more than three stories~~ Equation 31

Method WH-LOOPSZ

Where

~~Nunit₁ =~~ Number of dwelling units served by the loop section 1 = $\frac{N_{unit_k}}{N_{loop_k}}$

~~Nunit₂ =~~ Nunit₁

~~Nunit₃ =~~ $\frac{N_{unit_1}}{2}$

~~Nunit values are not necessarily integers.~~

Branch pipe parameters include number of branches, branch length, and branch diameter. The number of branches in water heating system k is calculated as (note: not necessarily an integer):

~~$N_{branch_k} = \frac{N_{unit_k}}{N_{unit_b}} N_{unit_k}$~~ Equation 32

Method WH-BRN

The branch pipe diameter shall be 0.75. ~~determined as follows:~~

~~Dia_b = 0.75; derived from Table B-6 based on Nunit_b~~ Equation 33

Method WH-BRSZ

Branch pipes connect riser pipes to pipes connected to individual hot water fixtures in dwelling units. The branch length (Len_b) shall be 2. ~~shall be determined as follows:~~

~~includes the vertical rise based on the number of floors in the building plus four feet of pipe to connect the branch to the recirculation loop.~~

~~$$Len_b = 4 + H_{floor} \times N_{floor} / 2$$
 Equation 34~~

~~$Len_b = 2$~~

Method WH-BRLEN

Proposed designs shall use the same branch configurations as those in the standard design. ~~Therefore, compliance software does not need to collect branch design information.~~

Table B-6: Pipe Size Schedule for Supply Pipe Sections (inch)

Number of dwelling units served (NUnit _n) or NUnit _b	Loop pipe nominal size Dia _n in California Plumbing Code Appendix A Pipe Sizing Method			Branch pipe nominal size Dia _b in California Plumbing Code Appendix M Pipe Sizing Method		
	Dia ₁	Dia ₂	Dia ₃	Dia ₁	Dia ₂	Dia ₃
< 25	1.5	<u>0.75</u>	<u>0.75</u>	<u>1</u>	<u>0.75</u>	1.0 <u>0.75</u>
25 ≤ N < 8	1.5	<u>1</u>	<u>0.75</u>	<u>1.5</u>	<u>1</u>	1.5 <u>0.75</u>
8 ≤ N < 21	2	<u>1.5</u>	<u>1.5</u>	<u>1.5</u>	<u>1.5</u>	<u>2</u>
21 ≤ N < 4236	2.5	<u>1.5</u>	<u>1.5</u>	<u>1.5</u>	<u>1.5</u>	<u>2.5</u>
4236 ≤ N < 68	3	<u>1.5</u>	<u>1.5</u>	<u>2</u>	<u>1.5</u>	<u>3</u>
68 ≤ N < 101	3.5	<u>2</u>	<u>1.5</u>	<u>3</u>	<u>1.5</u>	<u>3.5</u>
101 ≤ N < 145	4	<u>2</u>	<u>1.5</u>	<u>3</u>	<u>1.5</u>	<u>4</u>
145 ≤ N < 198	5	<u>2</u>	<u>1.5</u>	<u>3</u>	<u>1.5</u>	<u>5</u>
N ≥ 198	6	<u>2</u>	1.5	<u>3</u>	1.5	<u>6</u>

Source: California Energy Commission

B6. High-Rise Residential Buildings, Hotels and Motels

Simulations for high-rise residential buildings, hotels, and motels shall follow all the rules for central or individual water heating with the following exceptions:

- For central systems that do not use recirculation but use electric trace heaters, the program shall assume equivalency between the recirculation system and the electric trace heaters.
- For individual water heater systems that use electric trace heating instead of gas, the program shall assume equivalency.

B7. Energy Use of Individual Water Heaters

Once the hourly adjusted recovery load is determined for each water heater, the energy use for each water heater is calculated as described below and summed.

Water Heating Plant Pipe Heat Loss

Pipes in the heating plan are for establishing connection between water heating equipment, hot water storage equipment, and the master mixing valve. The hourly pipe heat loss of water heating plant in the kth system is calculated as:

$$HPPL_k = (PSA_{plant,k} \times f_{A,plant}) \times (U_{plant,k} \times f_{U,plant}) \times (T_{plant,k} - T_{Amb_plant,k}) \quad \text{Equation 45}$$

Where

PSA_{plant,k} – Pipe surface area (sqft) of pipes in the heat plant. Please note pipes downstream of the master mixing valve are considered as part of the hot water distribution system. It is calculated based on the number of dwellings units, Nunit_k, served by the heating system k as following:

2.4 × Nunit_k for heat pump water heater-based heating plant

3.5 × Nunit_k for natural gas water heater or boiler-based heating plant

f_{A,plant} – Correction factor to reflect improvement in pipe surface area reduction by using smaller pipes according to California Plumbing Code Appendix M. For the Standard Design, f_{A,plant} = 0.8. For the proposed design, the default value is 1.0. If plant pipes in the proposed design are sized according to California Plumbing Code Appendix M and the number of dwelling units served by the heating plant, Nunit_k, is more than 8, f_{A,plant} = 0.80.

U_{plant,k} – Average heat transfer coefficient between pipes and the ambient air, 25.2 Btu/hr-°F-sqft.

f_{U,plant} – Correction factor to reflect field installation quality of pipe insulation. For the Standard Design, f_{U,plant} = 1. For the proposed design, the default value is 1.40. If pipe insulation is field inspected and verified by a HERS Rater per Residential Reference Appendix RA2.2, f_{U,plant} = 1.

T_{plant,k} – Average pipe surface temperature for pipes in the heat plant, 125°F.

T_{Amb_plant,k} – Ambient temperature of the heating plant, which can be outside air or unconditioned air. Outside air temperatures shall be the dry-bulb temperature from the weather file. Hourly unconditioned air temperatures shall be average of outside air dry-bulb temperature and conditioned air dry-bulb temperature. For proposed designs, heating plant ambient temperature shall be based on user input of heating plant location. The standard design shall have the same heating plant ambient temperature as that of the proposed design.

Electricity Use for Circulation Pumping

For single family recirculation systems, hourly pumping energy is fixed as shown in Table B-8.

Multifamily recirculation systems typically have larger pump sizes, and, therefore, electrical energy use is calculated based on the installed pump size. The hourly recirculation pump electricity use (HEUP) is calculated by the hourly pumping schedule and the power of the pump motor as in the following equation.

$$HEUP_k = \frac{0.746 \times PUMP_k \times SCH_{k,m}}{\eta_k} \quad \text{Equation 4546}$$

Where

HEUP_k = Hourly electricity use for the circulation pump (kWh)

PUMP_k = Pump brake horsepower (bhp)

η_k = Pump motor efficiency

SCH_{k,m} = Operating schedule of the circulation pump. (See Table B-3) The operating schedule for the proposed design shall be based on user input control method. The standard design operation schedule is demand control.

Table B-8: Single family Recirculation Energy Use (kWh) by Hour of Day

Hour	Non-Demand-Controlled Recirculation	Demand-Controlled Recirculation
1	0.040	0.0010
2	0.040	0.0005
3	0.040	0.0006
4	0.040	0.0006
5	0.040	0.0012
6	0.040	0.0024
7	0.040	0.0045
8	0.040	0.0057
9	0.040	0.0054
10	0.040	0.0045
11	0.040	0.0037
12	0.040	0.0028
13	0.040	0.0025
14	0.040	0.0023
15	0.040	0.0021
16	0.040	0.0019
17	0.040	0.0028
18	0.040	0.0032
19	0.040	0.0033
20	0.040	0.0031
21	0.040	0.0027
22	0.040	0.0025
23	0.040	0.0023
24	0.040	0.0015
Annual Total	350	23

Source: California Energy Commission

11.4.2 Central HPWH Clean-up

Nonresidential and Multifamily Alternative Calculation Method Reference Manual

6.11.3 Multiple Dwelling Units – Central Water Heating

The energy performance of central water heating systems is determined by the primary heating equipment, primary heating storage volume, location, secondary heating equipment, secondary heating storage volume, set point controls, and the way in which the components are plumbed.

Water-heating ~~d~~Device.

If the proposed central water heating device uses electricity as the fuel source, the standard design is a central split heat pump water heater system that includes the following:

Primary single-pass, split-system heat pump plumbed to a primary storage volume. The standard design heat pump water heater output capacity and the primary storage tank capacity are automatically sized so that the heat pump and primary storage volume jointly meet the peak water used on the design (coldest) day. The algorithm sizes the primary tank volume to meet the peak water draw period and the heat pump output capacity so that the system runs for approximately sixteen hours on the design days.

The primary single-pass heat pump is a generic heat pump, based on the R-134 refrigerant operating cycle, with minimum output capacity as determined above.

In the standard design, the recirculation loop is decoupled from the primary system. The secondary heater and tank are connected to the primary system in series and both the primary tank outlet and hot water circulation return are connected to the bottom of the secondary tank.

The secondary tank is an electric resistance water heater with output heating capacity calculated as follows:

- Output Capacity (watts) = $1.75 * 100 * \text{Number of Dwelling Units}$

The secondary tank storage volume is determined by the following:

- Tank Volume (gallons) = 80 if Number of Dwelling Units < 48
- Tank Volume (gallons) = 120 if Number of Dwelling Units > 48

Both the primary and secondary storage tanks have insulation R-values of 16 ($^{\circ}\text{F ft}^2 \text{ hr/BTU}$)

The locations for the standard design storage tanks and heat pumps are the same as the proposed design.

The temperature setpoints are:

- Primary single-pass HPWH: ~~140~~135 $^{\circ}\text{F}$
- Secondary water heater: ~~136~~125 $^{\circ}\text{F}$
- Thermostatic mixing valve outlet: 125 $^{\circ}\text{F}$

If the proposed central water heating device uses gas or propane as the fuel source, the standard design uses natural gas-fired or propane commercial packaged boiler. In Climate 1 through 9, if the total installed water heating input capacity is 1 MMBtu/hr or greater, the standard design gas water-heating equipment thermal efficiency is 90 percent.

The appropriate efficiencies and standby losses for each standard water-heating device are then assigned to match the minimum federal requirements. The standards for consumer water heaters, as defined by 42 U.S.C 6291(16), are specified in 10 CFR 430.32(d); the standards for commercial water heaters, as defined by 42 U.S.C 6291(16), are specified in 10 CFR 431.110.

11.4.3 Individual HPWH Ventilation

There are no proposed changes to the ACM Reference Manual.

11.4.4 Individual DHW Electric-Ready

There are no proposed changes to the ACM Reference Manual.

11.4.5 Central DHW Electric-Ready

There are no proposed changes to the ACM Reference Manual.

11.5 Compliance Forms

11.5.1 CPC Appendix M

- **2022-LMCC-PLB-E: Domestic Water Heating: Low-Rise Multifamily Certificate of Compliance Domestic Water Heating:**
 - Adds a prescriptive requirement question on if the design team has selected Appendix A or Appendix M for distribution pipe sizing and documented it on the building plans.
- **2022-NRCC-PLB-E: Domestic Water Heating: Nonresidential Certificate of Compliance Domestic Water Heating:**
 - Adds a prescriptive requirement question on if the design team has selected Appendix A or Appendix M for distribution pipe sizing and documented it on the building plans.
- **2022-LMCI-PLB-E: Domestic Water Heating: Low-Rise Multifamily Certificate of Inspection Domestic Water Heating:**
 - Adds a prescriptive requirement question on if the construction team has installed distribution pipe sizing in accordance with Appendix A or Appendix M as specified on building plan documents.
- **2022-NRCI-PLB-E: Domestic Water Heating: Nonresidential Certificate of Inspection Domestic Water Heating:**
 - Adds a prescriptive requirement question on if the construction team has installed distribution pipe sizing in accordance with Appendix A or Appendix M as specified on building plan documents.

- **2022-LMCC-PRF-E: Domestic Water Heating: Low-Rise Multifamily Certificate of Compliance Domestic Water Heating:**
 - **Removes performance credit for Appendix M**
 - Adds a performance question on if the design team has selected Appendix A or Appendix M for distribution pipe sizing and documented it on the building plans.
- **2022-NRCC-PRF-E: Domestic Water Heating: Nonresidential Certificate of Compliance Domestic Water Heating:**
 - **Removes performance credit for Appendix M**
 - Adds a performance question on if the design team has selected Appendix A or Appendix M for distribution pipe sizing and documented it on the building plans.

11.5.2 Pipe Insulation Enhancement

- **2022-LMCC-PLB-E: Domestic Water Heating: Low-Rise Multifamily Certificate of Compliance Domestic Water Heating:** Adds mandatory requirement questions asking:
 - Are the mandatory requirements for pipe insulation stated in plumbing drawings with reference to Title 24, Part 6, Section 160.4?
 - Is there a specification table for materials required to meet insulation requirements for appurtenances, fittings, pipe supports, hangers, clamps, and extended stem isolation valves?
 - you are instructions and schematics provided for insulation installation on straight pipe, fittings, appurtenances and pipe supports, hangers, and clamps?
- **2022-NRCC-PLB-E: Domestic Water Heating: Nonresidential Certificate of Compliance Domestic Water Heating:** Adds mandatory requirement questions asking:
 - Are the mandatory requirements for pipe insulation stated in plumbing drawings with reference to Title 24, Part 6, Section 160.4?
 - Do you have specification table for materials required to meet insulation requirements for appurtenances, fittings, pipe supports, hangers, clamps, and extended stem isolation valves?
 - Did you provide instructions and schematics for insulation installation on straight pipe, fittings, appurtenances and pipe supports, hangers, and clamps?

- **2022-LMCI-PLB-E: Domestic Water Heating: Low-Rise Multifamily Certificate of Inspection Domestic Water Heating:** Adds mandatory requirement questions asking:
 - Are all mandatory requirements for pipe insulation met, including pipe insulation thickness in Title 24 Part 6 section 160.4?
 - Is all piping for multifamily domestic hot water systems insulated including the first 8 feet of inlet cold water piping to the heating plant?
 - Are all appurtenances at the heating plant, from a heating source to storage tank(s), or in between storage tanks and storage water heaters, and recirculation supply and return loop insulated?
 - Are appurtenance insulation thickness requirements met?
 - Are appurtenance insulation materials removable and re-installable?
 - Are insulation materials on the piping and appurtenances continuous?
 - Are pipe supports, hangers, and clamps attached on the outside of rigid pipe insulation?
 - Are all pipe insulation seams sealed along the length of the pipe and seams between adjacent sections of insulation material?
 - Is insulation for pipe elbows mitered and for tees notched, or tees and elbows can be pre-formed, or site fabricated with PVC covers?
 - Are extended stem isolation valves installed for the hot water piping or where pipe insulation is required?
- **2022-NRCI-PLB-E: Domestic Water Heating: Nonresidential Certificate of Inspection Domestic Water Heating:** Adds mandatory requirement questions asking:
 - Are all mandatory requirements for pipe insulation met, including pipe insulation thickness in Title 24 Part 6 section 160.4?
 - Is all piping for multifamily domestic hot water systems insulated including the first 8 feet of inlet cold water piping to the heating plant?
 - Are all appurtenances at the heating plant, from a heating source to storage tank(s), or in between storage tanks and storage water heaters, and recirculation supply and return loop insulated?
 - Are appurtenance insulation thickness requirements met?
 - Are appurtenance insulation materials removable and re-installable?
 - Are insulation materials on the piping and appurtenances continuous?
 - Are pipe supports, hangers, and clamps attached on the outside of rigid pipe insulation?

- Are all pipe insulation seams sealed along the length of the pipe and seams between adjacent sections of insulation material?
- Is insulation for pipe elbows mitered and for tees notched, or tees and elbows can be pre-formed, or site fabricated with PVC covers?
- Are extended stem isolation valves installed for the hot water piping or where pipe insulation is required?
- **2022-LMCV-PLB-21-HERS: HERS Verified Multifamily Central Hot Water System Distribution: Low-Rise Multifamily Certificate of Verification Domestic Water Heating:** Adds a mandatory requirement and prompts the HERS Rater to review the heating plant and distribution pipe insulation installation to ensure that it has been installed to meet the mandatory code requirements.
 - Does the DHW distribution system meet all mandatory requirements for pipe insulation including pipe insulation thickness in Title 24 Part 6 Section 160.4?
 - Is all piping for multifamily domestic hot water systems insulated including the first 8 feet of inlet cold water piping to the heating plant?
 - Are all appurtenances at the heating plant, from a heating source to storage tank(s), or in between storage tanks and storage water heaters, and recirculation supply and return loop insulated?
 - Are appurtenance insulation thickness requirements met?
 - Are appurtenance insulation materials removable and re-installable?
 - Are insulation materials on the piping and appurtenances continuous?
 - Are pipe supports, hangers, and clamps attached on the outside of rigid pipe insulation?
 - Are all pipe insulation seams sealed along the length of the pipe and seams between adjacent sections of insulation material?
 - Is insulation for pipe elbows mitered and for tees notched, or tees and elbows can be pre-formed, or site fabricated with PVC covers?
 - Are extended stem isolation valves installed for the hot water piping or where pipe insulation is required?
- **2022-NRCV-PLB-21-HERS: High-Rise Multifamily Central Hot Water System Distribution: Nonresidential Certificate of Verification Domestic Water Heating:** Adds a mandatory requirement and prompts the HERS Rater to review the heating plant and distribution pipe insulation installation to ensure that it has been installed to meet the mandatory code requirements.

- Does the DHW distribution system meet all mandatory requirements for pipe insulation including pipe insulation thickness in Title 24 Part 6 Section 160.4?
- Is all piping for multifamily domestic hot water systems insulated including the first 8 feet of inlet cold water piping to the heating plant?
- Are all appurtenances at the heating plant, from a heating source to storage tank(s), or in between storage tanks and storage water heaters, and recirculation supply and return loop insulated?
- Are appurtenance insulation thickness requirements met?
- Are appurtenance insulation materials removable and re-installable?
- Are insulation materials on the piping and appurtenances continuous?
- Are pipe supports, hangers, and clamps attached on the outside of rigid pipe insulation?
- Are all pipe insulation seams sealed along the length of the pipe and seams between adjacent sections of insulation material?
- Is insulation for pipe elbows mitered and for tees notched, or tees and elbows can be pre-formed, or site fabricated with PVC covers?
- Are extended stem isolation valves installed for the hot water piping or where pipe insulation is required?

11.5.3 Require Balancing Valve

- **2022-LMCC-PLB-E: Domestic Water Heating:** Adds compliance option questions asking:
 - Are thermal balancing valves specified?
 - What is the number of supply riser pipes specified?
 - What is the number of return pipe loops specified?
 - What is the calculated length of return piping for each return pipe loop?
 - What is the thermal balancing valve specified temperature set point?
 - Is the specified pump variable speed?
 - Is the specified pump control method based on pump differential pressure control?
- **2022-NRCC-PLB-E: Domestic Water Heating:** Adds compliance option questions asking:
 - Are thermal balancing valves specified?
 - What is the number of supply riser pipes specified?
 - What is the number of return pipe loops specified?

- What is the calculated length of return piping for each return pipe loop?
- What is the thermal balancing valve specified temperature set point?
- Is the specified pump variable speed?
- Is the specified pump control method based on pump differential pressure control?
- **2022-LMCI-PLB-E: Domestic Water Heating:** Adds compliance option questions asking:
 - Are thermal balancing valves installed?
 - What is the number of installed supply riser pipes installed?
 - What is the number of installed return pipe loops installed?
 - Is the length of return piping consistent with the design drawings?
 - If not, what is the return piping length for each return pipe loop?
 - What is the thermal balancing valve installed temperature set point?
 - Is the specified pump variable speed, and is the pump control method based on pump differential pressure control?
- **2022-NRCI-PLB-E: Domestic Water Heating:** Adds compliance option questions asking:
 - Are thermal balancing valves installed?
 - What is the number of installed supply riser pipes installed?
 - What is the number of installed return pipe loops installed?
 - Is the length of return piping consistent with the design drawings?
 - If not, what is the return piping length for each return pipe loop?
 - What is the thermal balancing valve installed temperature set point?
 - Is the specified pump variable speed?
 - Is the pump control method based on pump differential pressure control?

11.5.4 Require MMV

- **2022-LMCC-PLB-E: Domestic Water Heating: Low-Rise Multifamily Certificate of Compliance Domestic Water Heating:** Adds prescriptive requirement questions asking:
 - Are ASSE 1017-approved thermostatic MMV(s) specified?
 - Are manufacturer's instructions and schematic for installation and commissioning of the MMV provided in the plumbing plans?
 - Do the plumbing plans indicate the water mixing parameters (plant hot water supply temperature, MMV outlet temperature, recirculation return

temperature, recirculation flow rate, percentage return water to cold side of mixing valve, percentage hot water to mixing valve)?

- Do the water mixing parameters exceed the mixing capability of the specified MMV? If yes, are instructions to install and commission a balancing valve to prevent temperature creep provided in the plumbing plans?
- **2022-NRCC-PLB-E: Domestic Water Heating: Nonresidential Certificate of Compliance Domestic Water Heating:** Adds prescriptive requirement questions asking:
 - Are ASSE 1017-approved thermostatic MMV(s) specified?
 - Are manufacturer's instructions and schematic for installation and commissioning of the MMV provided in the plumbing plans?
 - Do the plumbing plans indicate the water mixing parameters (plant hot water supply temperature, MMV outlet temperature, recirculation return temperature, recirculation flow rate, percentage return water to cold side of mixing valve, percentage hot water to mixing valve)?
 - Do the water mixing parameters exceed the mixing capability of the specified MMV? If yes, are instructions to install and commission a balancing valve to prevent temperature creep provided in the plumbing plans?
- **2022-LMCI-PLB-E: Domestic Water Heating: Low-Rise Multifamily Certificate of Inspection Domestic Water Heating:** Adds prescriptive requirement questions asking:
 - Are ASSE 1017-approved thermostatic MMV(s) installed and commissioned to meet mandatory code requirements as instructed in the plumbing plans?
- **2022-NRCI-PLB-E: Domestic Water Heating: Nonresidential Certificate of Inspection Domestic Water Heating:** Adds prescriptive requirement questions asking:
 - Are ASSE 1017-approved thermostatic MMV(s) installed and commissioned to meet mandatory code requirements as instructed in the plumbing plans?

11.5.5 Central HPWH Clean-up

Compliance documents listed below would need to be revised.

- 2022-LMCC-PLB-E: Low-Rise Multifamily Certificate of Compliance Domestic Water Heating:

- Update primary central HPWH prescriptive requirement per proposed code change.
- Adds an alternative prescriptive option for central HPWH whether the selected system product is on the NEEA AWHS Tier 2 qualified product list.
- 2022-NRCC-PLB-E: Nonresidential Certificate of Compliance Domestic Water Heating:
 - Update primary central HPWH prescriptive requirement per proposed code change.
 - Adds an alternative prescriptive option for central HPWH whether the selected system product is on the NEEA AWHS Tier 2 qualified product list.
- 2022-LMCI-PLB-E: Low-Rise Multifamily Certificate of Inspection Domestic Water Heating:
 - Update primary central HPWH prescriptive requirement per proposed code change.
 - Adds an alternative prescriptive option for central HPWH whether the selected system product is on the NEEA AWHS Tier 2 qualified product list.
- 2022-NRCI-PLB-E: Nonresidential Certificate of Inspection Domestic Water Heating:
 - Update primary central HPWH prescriptive requirement per proposed code change.
 - Adds an alternative prescriptive option for central HPWH whether the selected system product is on the NEEA AWHS Tier 2 qualified product list.

11.5.6 Individual HPWH Ventilation

Compliance documents listed below would need to be revised.

- **2022-LMCC-PLB-01-E:** Adds reference to mandatory ventilation requirement in section F.
- **2022-LMCI-PLB-E:** Adds reference to mandatory ventilation requirement.
- **2022-LMCI-PLB-01-E:** Adds reference to mandatory ventilation requirement in section G.
- **2022-LMCI-PLB-02-E:** Adds reference to mandatory ventilation requirement in section F.

- **2022-LMCI-PLB-21-H:** Adds reference to mandatory ventilation requirement in section G.
- **2022-LMCI-PLB-22-H:** Adds reference to mandatory ventilation requirement in section F.
- **2022-LMCV-PLB-21-H:** Adds reference to mandatory ventilation requirement in section G.
- **2022-LMCV-PLB-22-H:** Adds reference to mandatory ventilation requirement in section F.
- **2022-NRCC-PLB-E:** Adds reference to mandatory ventilation requirement in section F.
- **2022-NRCI-PLB-E:** Adds reference to mandatory ventilation requirement.
- **2022-NRCV-PLB-21-H:** Adds reference to mandatory ventilation requirement in section G.
- **2022-NRCV-PLB-22-H:** Adds reference to mandatory ventilation requirement in section F.
- **2022-CF1R-ADD-01-E:** Adds reference to mandatory ventilation requirement in section L.
- **2022-CF1R-ALT-01-E:** Adds reference to mandatory ventilation requirement in section J.
- **2022-CF1R-NCB-01-E:** Adds reference to mandatory ventilation requirement in section M.
- **2022-CF1R-ADD-02-E:** Adds reference to mandatory ventilation requirement.
- **2022-CF1R-ALT-05-E:** Adds reference to mandatory ventilation requirement in section H.
- **2022-CF2R-ADD-02-E:** Adds reference to mandatory ventilation requirement in section O.
- **2022-CF2R-ALT-05-E:** Adds reference to mandatory ventilation requirement in section O.
- **2022 CF2R-PLB-02-E:** Adds reference to mandatory ventilation requirement in section F.
- **2022 CF2R-PLB-22-H:** Adds reference to mandatory ventilation requirement in section F.
- **2022 CF3R-PLB-22-H:** Adds reference to mandatory ventilation requirement in section F.

11.5.7 Individual DHW Electric-Ready

Compliance documents listed below would need to be revised.

- **2022-LMCC-PLB-E: Domestic Water Heating** Adds a mandatory requirement question on if the design team has met all requirements.
- **2022-NRCC-PLB-E: Domestic Water Heating** –Adds a mandatory requirement question on if the design team has met all requirements.
- **2022-LMCI-PLB-E: Domestic Water Heating** – Adds a mandatory requirement question on if the construction team has met all requirements.
- **2022-NRCI-PLB-E: Domestic Water Heating** –Adds a mandatory requirement question on if the construction team has met all requirements.

11.5.8 Central DHW Electric-Ready

Compliance documents listed below would need to be revised.

- **2022-LMCC-PLB-E: Domestic Water Heating** Adds a mandatory requirement question on if the design team has met all requirements.
- **2022-NRCC-PLB-E: Domestic Water Heating** –Adds a mandatory requirement question on if the design team has met all requirements.
- **2022-LMCI-PLB-E: Domestic Water Heating** – Adds a mandatory requirement question on if the construction team has met all requirements.
- **2022-NRCI-PLB-E: Domestic Water Heating** –Adds a mandatory requirement question on if the construction team has met all requirements.

12. Bibliography

2022. *10 CFR § 431.102*. <https://www.ecfr.gov/current/title-10/chapter-II/subchapter-D/part-431/subpart-G/section-431.102>.
2022. *10 CFR § 431.106*. <https://www.ecfr.gov/current/title-10/chapter-II/subchapter-D/part-431#431.106>.
- n.d. "26 Code of Federal Regulations Section 1.42-10(c)."
- ACEEE. n.d. "Energy Equity." *ACEEE.org*. Accessed 2023. <https://www.aceee.org/topic/energy-equity>.
- ACEEE, ASAP, Bradford-White, CFA, NRDC, NEEA, and Rheem. 2022. "Joint stakeholder recommendations for amended energy conservation standards for consumer water heaters." *Regulations.gov*. October 21. <https://www.regulations.gov/comment/EERE-2017-BT-STD-0019-0049>.
- Acorn. 2020. "Command Station Spec Sheet." *Acorn Controls*. 02 21. Accessed 01 16, 2023. <https://www.acorneng.com/uploads/fileLibrary/CSMV.pdf>.
- AEA. n.d. "Site observation reports and photographs."
- Ali Rahmatmand et al. 2020. "Energy and thermal comfort performance evaluation of thermostatic and electronic mixing valves used to provide domestic hot water of buildings." *Energy and Buildings Journal*. 04 01. Accessed 01 08, 2023. <https://www.sciencedirect.com/science/article/abs/pii/S0378778819332426?via%3Dihub>.
- . 2019. "Flowmix Performance Compared to a TMV." *Flowmix*. 05 12. Accessed 01 07, 2023. https://flowmix.ca/wp-content/uploads/2020/12/3.Flowmix-performance-report_White-paper-UofT.pdf.
- Alliance for Water Efficiency. 2021. "A Review of Connection Fees and Service Charges by Meter Size." *IAPMO*. 05 01. Accessed 12 28, 2022. <https://www.iapmo.org/media/25939/awe-meter-size-connection-fee-research.pdf>.
- ASHRAE. 2019. "Chapter 38. Owning and Operating Costs." In *ASHRAE Handbook - HVAC Applications*, by ASHRAE.
- . 2023. "GUIDANCE ON REDUCING THE RISK OF LEGIONELLA." *ASHRAE*. Accessed 01 16, 2023. <https://www.ashrae.org/technical-resources/standards-and-guidelines/guidance-on-reducing-the-risk-of-legionella>.
- n.d. *ASPE*. Accessed 2020. <https://connect.aspe.org/home>.

- ASSE Scald Awareness Task Group. 2017. "Guidelines for Temperature Control Devices in Domestic Hot Water Systems." *ASSE International*. 02 09. Accessed 01 07, 2023. <https://www.asse-plumbing.org/media/21934/guidelines-for-temp-control-devices.pdf>.
- Association for Energy Affordability. n.d. <https://aea.us.org/>.
- Association, National Energy Assistance Directors. 2011. "2011 National Energy Assistance Survey Final Report."
- Bailes III, Allison A. 2017. *Designing Duct System Vents for Good Air Flow*. January 18. <https://www.greenbuildingadvisor.com/article/designing-duct-system-vents-for-good-air-flow>.
- BG's Plumbing Class. 2021. *Water Sizing Example Thru Appendix A UPC*. Accessed 12 28, 2022. <https://www.youtube.com/watch?v=4sT9T5k8nmg>.
- Blakenship, Britney, J Renner, Heidi Werner, Marissa Lerner, and Kelly Cunningham. 2020. "Hand-in-Hand: Environmental and Social Justice Communities and California Energy Code." *ACEEE Summer Study on Energy Efficiency in Buildings*.
- Blankenship, Britney: J Renner, H Werner, M Lerner, K Cunningham. 2020. *Hand-in-Hand: Environmental and Social Justice Communities and California Energy Code*. ACEEE Summer Study on Energy Efficiency in Buildings.
- Buchberger, Steven, Toritseju Omaghomi, Timothy Wolfe, Jason Hewitt, and Daniel Cole. 2017. "Peak Water Demand Study: Probability Estimates for Efficient Fixtures in Single and Multi-family Residential." *IAPMO*. 01 01. Accessed 12 28, 2022. <https://www.iapmo.org/media/3857/peak-water-demand-study-executive-summary.pdf>.
- C&S_Reach_Code. 2022. "Master Factsheet on UPC Appendix M." *Local Energy Codes*. 02 16. Accessed 01 04, 2023. https://localenergycodes.com/download/983/file_path/fieldList/Appendix%20M%20Fact%20Sheet.pdf.
- CALEPA. 2022. *FINAL DESIGNATION OF DISADVANTAGED COMMUNITIES PURSUANT TO SENATE BILL 535*. 6 5. Accessed 12 8, 2022. https://calepa.ca.gov/wp-content/uploads/sites/6/2022/05/Updated-Disadvantaged-Communities-Designation-DAC-May-2022-Eng.a.hp_-1.pdf.
- California Air Resources Board. 2020. "Prohibitions on Use of Certain Hydrofluorocarbons in Stationary Refrigeration, Chillers, Aerosols-Propellants, and Foam End0Uses Regulation." *CARB*. <https://ww2.arb.ca.gov/rulemaking/2020/hfc2020>.

- California Energy Commission. 2020. 7 20. <https://www.energy.ca.gov/programs-and-topics/programs/building-initiative-low-emissions-development-program>.
- . n.d. <https://www.energy.ca.gov/programs-and-topics/programs/electric-program-investment-charge-epic-program>.
- California Energy Commission. 2022. "2025 California Energy Code Measure Proposal to the California Energy Commission." <https://www.energy.ca.gov/media/3538>.
- . n.d. *2025 Energy Code Compliance Software, Research Version*. Accessed 2022. <https://www.energy.ca.gov/programs-and-topics/programs/building-energy-efficiency-standards/2025-building-energy-efficiency-1>.
- . 2019. *California Residential Appliance Saturation Study*. <https://www.energy.ca.gov/data-reports/surveys/2019-residential-appliance-saturation-study>.
- California Energy Commission. 2019. "Executive Director Determination Pursuant for Section 150.1 (c)SC." <https://efiling.energy.ca.gov/GetDocument.aspx?tn=231318&DocumentContentId=63067> .
- . 2022. "Final Staff Workshop on Energy Accounting for the 2025 Building Energy Efficiency Standards." *California Energy Commission*. November 10. <https://www.energy.ca.gov/event/workshop/2022-11/final-staff-workshop-energy-accounting-2025-building-energy-efficiency>.
- . 2022. "Final Staff Workshop on Energy Accounting for the 2025 Building Energy Efficiency Standards." *California Energy Commission*. Prepared for the California Energy Commission. November 10. <https://www.energy.ca.gov/event/workshop/2022-11/final-staff-workshop-energy-accounting-2025-building-energy-efficiency>.
- . 2023. *GRANT REQUEST FORM*. 1 17. <https://www.energy.ca.gov/filebrowser/download/723>.
- . 2022. "Housing and Commercial Construction Data - Excel." https://ww2.energy.ca.gov/title24/documents/2022_Energy_Code_Data_for_Measure_Proposals.xlsx.
- California Public Utilities Commission (CPUC). 2015b. "Water/Energy Cost-Effectiveness Analysis: Revised Final Report." Prepared by Navigant Consulting, Inc. <http://www.cpuc.ca.gov/WorkArea/DownloadAsset.aspx?id=5360>.
- California Public Utilities Commission. 2015a. "Water/Energy Cost-Effectiveness Analysis: Errata to the Revised Final Report." Prepared by Navigant Consulting, Inc. . <http://www.cpuc.ca.gov/WorkArea/DownloadAsset.aspx?id=5350>.

- California Tax Credit Allocation Committee, California Departments of Housing and Community Development, California Housing Finance Agency, and California Debt Limit Allocation Committee. 2014. "Affordable Housing Cost Study: Analysis of the Factors that Influence the Cost of Building Multifamily Affordable Housing in California."
- CalWEP. 2021. "Appendix M Fact Sheet." *California Water Efficiency Partnership*. 10. Accessed 12 28, 2022. <https://calwep.org/wp-content/uploads/2021/10/Appendix-M-fact-sheet-FINAL.pdf>.
- CARB. 2022. "2022 State Strategy for the State Implementation Plan." *CARB Website*. September 22. https://ww2.arb.ca.gov/sites/default/files/2022-08/2022_State_SIP_Strategy.pdf.
- CEC. 2018. "Energy Equity Indicators Tracking Progress." *Energy.ca.gov*. June 25. Accessed 2023. https://www.energy.ca.gov/sites/default/files/2019-12/energy_equity_indicators_ada.pdf.
- City of Oakland. 2023. *Section 15.04.3.5065 To Adopt Appendix M Of The 2022 California Plumbing Code*. 03 07. Accessed 08 17, 2023. <https://oakland.legistar.com/LegislationDetail.aspx?ID=6012586&GUID=B8A4F6EC-57D7-43AC-91FD-FA84BA26361C&Options=&Search=>.
- City of San Jose. 2023. *Chapter 24.04 - PLUMBING CODE*. https://library.municode.com/ca/san_jose/codes/code_of_ordinances?nodeId=TI T24TECO_CH24.04PLCO.
- Cluett, Rachel, and J Amann. 2015. *Multiple Benefits of Multifamily Energy Efficiency for Cost Effectiveness Screening*. ACEEE.
- Cluett, Rachel, J Amann. 2015. "Multiple Benefits of Multifamily Energy Efficiency for Cost-Effectiveness Screening." *American Council for an Energy-Efficiency Economy*.
- County of Santa Cruz. 2022. "Chapter 12.10 Building Regulations." *County Code*. 01 01. Accessed 08 22, 2023. <https://www.codepublishing.com/CA/SantaCruzCounty/#!/SantaCruzCounty12/SantaCruzCounty1210.html#12.10.235>.
- CPUC. 2022. "CPUC Decision Makes California First State in Country to Eliminate Natural Gas Subsidies to Accelerate Building Decarbonization." *CPUC Website*. September 15. <https://docs.cpuc.ca.gov/PublishedDocs/Published/G000/M496/K979/496979465.PDF>.
- . n.d. "Disadvantaged Communities." Accessed 2023. <https://www.cpuc.ca.gov/industries-and-topics/electrical->

energy/infrastructure/disadvantaged-communities#:~:text=What%20is%20a%20Disadvantaged%20Community,%2C%20health%2C%20and%20environmental%20burdens.

- CTCAC. 2014. *Affordable Housing Cost Study: Analysis of the Factors that Influence the Cost of Building Multifamily Affordable Housing in California*. California Department of Housing and Community Development, California Housing Finance Agency, California Debt Limit Allocation Committee.
- DC Fiscal Policy Institute. 2017. "Style Guide for Inclusive Language." *DCFPI*. December. https://www.dcfpi.org/wp-content/uploads/2017/12/Style-Guide-for-Inclusive-Language_Dec-2017.pdf.
- Delagah, Amin. 2021. *Viewpoints from Using Various Check and Mixing Valves in the Lab to Mimic the Operation of Multi-Family HW Distribution Systems*. 03 18. Accessed 01 06, 2023. https://drive.google.com/file/d/1UkUXWGItdtqUFMHjcJIDs2_GXdrmCTrjr/view.
- n.d. "Dodge Data & Analytics." <https://sso.construction.com/SingleSignOn/Login.aspx?redirectUrl=http%3a%2f%2fnetwork2.construction.com%2fAuthorizeAccess.aspx%3fReturnUrl%3d%252f>.
- Drehobl, Ariel, L Ross, and R Ayala. 2016. *Lifitng the High Energy Burden in America's Largest Cities: How Energy Efficiency Can Improve Low-Income and Underserved Communities*. American Council for an Energy Efficiency Economy.
- Drehobl, Ariel: L Ross: R Ayala. 2020. *How High are Household Energy Burdens? An Assessment of National and Metropolitan Energy Burden Across the United States*. American Council for an Energy-Efficiency Economy.
- E3. 2019. https://www.ethree.com/wp-content/uploads/2019/04/E3_Residential_Building_Electrification_in_California_April_2019.pdf.
- Ecotope. 2020. "Ecosizer Manual." *Ecotope*. 10 01. Accessed 03 03, 2023. <https://ecosizer.ecotope.com/static/pdfs/ecosizer-chpwh-sizing-tool-manual.pdf>.
- . 2009. "Multifamily Billing Analysis: New Mid-Rise Buildings in Seattle." *Prepared for: City of Seattle Department of Planning & Development*. Ecotope.
- Energy Star. 2018. "ENERGY STAR Program Requirements for Commercial Water Heaters Partner Commitments." 10 1. https://www.energystar.gov/sites/default/files/Program%20Requirements_Commercial%20Water%20Heaters_Final%20Version%202.0_12%2029%2017_0.pdf.
- Federal Reserve Economic Data (FRED). n.d. Accessed September 14, 2022. <https://fred.stlouisfed.org/release/tables?eid=258470&rid=144> .

- . n.d. *Data series relied on: Net Domestic Private Investment, Corporate Profits After Taxes*. Accessed September 18, 2022. <https://fred.stlouisfed.org> .
- Foster City. 2023. *Foster City Municipal Code Chapter 15.16*. <https://www.codepublishing.com/CA/FosterCity/?FosterCity15/FosterCity1516.html&?f>.
- Freidt, Kevin. 2021. "When Does Digital Mixing Make Sense?" *PHCP Pros*. 02 01. Accessed 01 06, 2023. <https://www.phcppros.com/articles/12736-when-does-digital-mixing-make-sense>.
- Gable, Jessica. 2021. *California's Cities Lead the Way on Pollution-Free Homes and Buildings*. July 22. <https://www.sierraclub.org/articles/2021/07/californias-cities-lead-way-pollution-free-homes-and-buildings>.
- Goldsmith, Leo, and Michelle L. Bell. 2021. "Queering Environmental Justice: Unequal Environmental Health Burden on the LGBTQ+ Community." *American Journal of Public Health*. <https://ajph.aphapublications.org/doi/10.2105/AJPH.2021.306406>.
- Hoeschele, Marc, and James Linwood Haile. 2022. *Evaluation of Unitary Heat Pump Water Heaters with Load-Shifting Controls in a Shared Multi-Family Configuration*. Rosemead: Emerging Technologies Coordinating Council. <https://www.etcc-ca.com/reports/evaluation-unitary-heat-pump-water-heaters-load-shifting-controls-shared-multi-family>.
- Holby. 2020. "The Importance of Hot Water Recirculation." *Holby*. 02 01. Accessed 01 16, 2023. <https://www.holby.com/wp-content/uploads/2020/03/The-Importance-of-Hot-Water-Recirculation-Rev-Feb-20.pdf>.
- IAPMO. 2019. "Water Demand Calculator User Guide ." *IAPMO*. 06 03. Accessed 12 28, 2022. https://www.iapmo.org/media/21768/wdc_conciseuserguide.pdf.
- . 2022. "Water Demand Calculator Version 2.1." *WE Stand*. Accessed 12 28, 2022. <https://www.iapmo.org/water-demand-calculator/>.
- IEA. 2014. *Capturing the Multiple Benefits of Energy Efficiency*. International Energy Agency.
- InterNACHI. 2023. *Standard Estimated Life Expectancy Chart for Homes*. <https://www.nachi.org/life-expectancy.htm>.
- Internal Revenue Service, Treasury. 2011. "CFR-2011-title26-vol1-sec1-42-10.pdf." *Govinfo.gov*. Accessed 2023. <https://www.govinfo.gov/content/pkg/CFR-2011-title26-vol1/pdf/CFR-2011-title26-vol1-sec1-42-10.pdf>.
- International Energy Agency. 2014. "Capturing the Multiple Benefits of Energy Efficiency."

- Johns Hopkins Medicine. 2008. "Noxious Gas Stove Emissions Worsen Asthma Symptoms In Young Children." *Science Daily*. 10. <https://www.sciencedaily.com/releases/2008/10/081013131530.htm>.
- Kenney, Michael, Heather Bird, and Heriberto Rosales. 2019. *2019 California Energy Efficiency Action Plan*. Publication Number: CEC- 400-2019-010-CMF , California Energy Commission. Kenney, Michael, Heather Bird, and Heriberto Rosales. 2019. 2019 California Energy Efficiency Action Plan. California Energy Commission. Publication Number: CEC- 400-2019-010-CMF .
- Klein, Gary. 2021. "Memorandum to Support Statewide Adoption of Uniform Plumbing ." *California Water Efficiency Partnership*. 11 1. Accessed 12 28, 2022. https://calwep.org/wp-content/uploads/2021/10/2021-1012_Memo-to-Support-Adoption-of-UPC-Appendix-M_v1.0.pdf.
- Knight, Paul. 2021. *Working Pressure*. 07 26. Accessed 01 06, 2023. <https://www.workingpressuremag.com/raising-the-standard/>.
- Laaidi, Karine, A Zeghnoun, B Dousset, P Bretin, S Vendentorren, and P Beaudeau. 2012. "The Impact of Heat Islands on Mortality in Paris during the August 2003 Heat Wave." *Environmental Health Perspectives*.
- Laaidi, Karine: A Zeghnoun: B Dousset: P Bretin: S Vandentorren: E Giraudet: P Beaudeau. 2012. "The Impact of Heat Islands on Mortality in Paris during the August 2003 Heat Wave." *Environmental Health Perspectives*.
- Larson, Ben, and Sam Larson. 2022. *Heat Pump Water Heaters in Small Spaces Lab Testing Study: The Amazing Shrinking Room*. Portland: Northwest Energy Efficiency Alliance.
- Larson, Ben, Sam Larson, and Maya Gantley. 2023. *Laboratory Testing of Residential Heat Pump Water Heater Performance: Impact of Airflow and Space Configuration*. <https://www.etcc-ca.com/reports/code-readiness-data-brief-laboratory-testing-residential-heat-pump-water-heater-performance>.
- Lawler. 2022. "Mixing System." *Lawler*. 11 01. Accessed 01 16, 2023. https://www.temperedwater.com/wp-content/uploads/2022/11/86640_6110_MS_SDS.pdf.
- . 2022. "Model 804 I&M Manual." *Lawler Manufacturing Co. Inc*. Accessed 01 16, 2023. https://www.temperedwater.com/wp-content/uploads/documents/SDS/73005_804_STD_SDS.pdf.
- . 2022. "Series 61 I&M Manual." *Lawler Manufacturing Co., Inc*. 08 01. Accessed 01 16, 2023. https://www.temperedwater.com/wp-content/uploads/2022/08/61-SERIES_STD_IMM.pdf.

- Leonard. 2020. *Leonard Water Temperature Controls-Submittal Data Sheet*. 06 01. Accessed 01 16, 2023. <https://www.leonardvalve.com/products/lines/209/product/4640>.
- . 2018. "Eco-Mix Data Sheet." *Leonard Water Temperature Controls-Submittal Data Sheet*. 08 01. Accessed 01 18, 2023. <https://www.leonardvalve.com/products/lines/207/product/4600>.
- . 2022. *History*. 01 06. Accessed 01 06, 2022. <https://leonardvalve.com/history>.
- Meng, Ying-Ying, Susan H Babey, Theresa A Hastert, and E Richard Brown. 2007. *California's racial and ethnic minorities more adversely affected by asthma*. February. Accessed 12 8, 2022. [https://pubmed.ncbi.nlm.nih.gov/17338094/#:~:text=Among%20California%20children%2C%20the%20prevalence,\(7%25%3B%20Exhibit%201\)](https://pubmed.ncbi.nlm.nih.gov/17338094/#:~:text=Among%20California%20children%2C%20the%20prevalence,(7%25%3B%20Exhibit%201)).
- National Association of Home Builders. 2007. "Study of Life Expectancy of Home Components." Washington, DC.
- NEEA. 2022. <https://neea.org/img/documents/advanced-water-heating-specification-v8.0.pdf>.
- . 2022. *A Specification for Residential, Commercial – Multifamily, and Industrial Water Heaters and Heating Systems*. march. Accessed 3 2023. <https://neea.org/img/documents/Advanced-Water-Heating-Specification.pdf>.
- . 2022. "Advanced Water Heating Specification v8.0." *NEEA*. March. <https://neea.org/resources/advanced-water-heating-specification-v8.0>.
- . 2022. "Commercial Multifamily Heat Pump Water Heater Qualified Products List." <https://neea.org/img/documents/commercial-HPWH-qualified-products-list.pdf>.
- Newsom, Gavin. 2022. *Letter to Liane Randolph, Chair, California Air Resources Board*. July 22. <https://www.gov.ca.gov/wp-content/uploads/2022/07/07.22.2022-Governors-Letter-to-CARB.pdf?emrc=1054d6>.
- NMHC. 2022. *2022 Renter Preferences Survey Report*. Grace Hill, Kingsley Surveys. <https://www.nmhc.org/research-insight/research-report/nmhc-grace-hill-renter-preferences-survey-report/>.
- Northwest Energy Efficiency Alliance. 2022. "Plug-In Heat Pump Water Heaters: An Early Look to 120-Volt Products." *Plug-In Heat Pump Water Heaters: An Early Look to 120-Volt Products*. August 30. <https://neea.org/resources/plug-in-heat-pump-water-heaters-an-early-look-to-120-volt-products>.
- Norton, Ruth Ann, & B Brown. 2014. "Green & Healthy Homes Initiative: Improving Health, Economic, and Social Outcomes Through Integrated Housing Intervention." *Environmental Justice* Vol. 7 (Nbr. 6.).

- Norton, Ruth Ann, and Brendan Wade Brown. 2014. "Green & Helthy Homes Initiative: Improving Health, Economic, and Social Outcomes Through Integrated Housing Intervention." *Environmental Justice* 151-157.
- Pacific Gas and Electric Company. 2013. 3. https://www.pge.com/includes/docs/pdfs/mybusiness/energysavingsrebates/partnersandtradepros/eeis/search/3P_fs_CAMulti-FamilyNewHomes.pdf.
- Perachova, Krafcik Milan and Jana. 2019. "Experimental Measurements of Hot Water Stratification in a Heat Storage Tank." *IOP Conference Series*. Accessed 03 03, 2023. <https://iopscience.iop.org/article/10.1088/1757-899X/471/2/022014/pdf>.
- PHCC-National Association. 2021. *The Water Demand Calculator Leaves Home*. 07 21. Accessed 01 04, 2023. <https://www.phccweb.org/news/the-water-demand-calculator-leaves-home/>.
- PIER. 2013. *Multifamily Central Domestic Hot Water Distribution Systems*. Final Project Report, Gold River: Heschong Mahone Group, Inc.
- Power, Margaret. 2007. *Technical Report of Accomplishments of the Weatherization Leveraging Partnership Project*. Economic Opportunities Study.
- Power, Margaret. 2007. "Technical Report of Accomplishments of the Weatherization Leveraging Partnership Project." *Economic Opportunity Studies*.
- Powers. 2017. "Piping / Recirculation Diagram." *Watts*. Accessed 01 18, 2023. <https://www.watts.com/dfsmedia/0533dbba17714b1ab581ab07a4cbb521/35725-source/s-p-mm-hilo>.
- Pytel, Brandon. 2019. "UC Calculator Drives Water Efficiency in Homes." *UC News*. 02 20. Accessed 01 04, 2023. <https://www.uc.edu/news/articles/2019/02/n2068889.html>.
- Rose, Erin; Hawkins, Beth. 2020. *Background Data and Statistics on Low- Income Energy Use and Burden for the Weatherization Assistance Program: Update for Fiscal Year 2020*. Oak Ridge National Laboratory.
- Sacramento Municipal Utility District. n.d. <https://www.smud.org/>.
- Santec Architecture Inc. 2021. "Materials and Labor Cost Savings Potential Summary Report." *International Association of Plumbing and Mechanical Officials*. Accessed 12 28, 2022. https://www.iapmo.org/media/25276/water_demand_calculator_report_summary.pdf.
- . 2020. "Water Demand Calculator Study." *International Association of Plumbing and Mechanical Officials*. 12 1. Accessed 12 28, 2022. https://www.iapmo.org/media/25249/water_demand_calculator_study-final.pdf.

- SBW Consulting, Inc. 2022. *Water-Energy Calculator 2.0 Project Report*. Project Report, San Francisco: California Public Utility Commission.
- Seals, Brady, and Andee Krasner. 2020. "Gas Stoves: Health and Air Quality Impacts and Solutions." *RMI.com*. <https://rmi.org/insight/gas-stoves-pollution-health/>.
- Smargiassi, Audrey, M Fournier, C Griot, Y Baudouin, and T Kosatsky. 2008. "Prediction of the Indoor Temperatures of an Urban Area with an In-Time Regression Mapping Approach." *Journal of Exposure Science and Environmental Epidemiology*.
- Smargiassi, Audrey; M Fournier; C Griot; Y Baudouin; T Kosatsky. 2008. "Prediction of the indoor temperatures of an urban area with an in-time regression mapping approach." *Journal of Exposure Science and Environmental Epidemiology*.
- Sonoma Clean Power. 2020. 7 1. <https://sonomacleanpower.org/uploads/documents/AEB-Program-Manual-2020-08-10.pdf>.
- State of California. n.d. *Employment Development Department, Quarterly Census of Employment and Wages (data search tool)*. Accessed September 1, 2022. <https://www.labormarketinfo.edd.ca.gov/cgi/dataanalysis/areaselection.asp?table name=industry>.
- . n.d. "Government Code Title 7 Division 1 Chapter 1.5 Article 4." *California Legislative Information*. Accessed 2023. https://leginfo.legislature.ca.gov/faces/codes_displaySection.xhtml?sectionNum=65040.12.&lawCode=GOV.
- State of California, Employment Development Department. n.d. *Quarterly Census of Employment and Wages (data search tool)*. Accessed September 1, 2022. <https://www.labormarketinfo.edd.ca.gov/cgi/dataanalysis/areaselection.asp?table name=industry>.
- Statewide CASE Team. 2023. "Multifamily Domestic Hot Water Utility-Sponsored Stakeholder Meeting." *title24stakeholders.com*. February 17. <https://title24stakeholders.com/event/multifamily-domestic-hot-water-utility-sponsored-stakeholder-meeting/>.
- . 2021. "Voluntary Energy Efficiency Requirements for Title 24, Part 11 (CALGreen)." June. <https://title24stakeholders.com/wp-content/uploads/2021/06/Final-to-Post-CALGreen-Voluntary-Requirements-Proposal.pdf>.
- Statewide CASE Team. 2011. *Water and Space Heating ACM Improvement*. CASE Report, San Francisco: California Public Utilities Commission. http://title24stakeholders.com/wp-content/uploads/2017/10/2013_CASE-Report_Water-and-Space-Heating-ACM-Improvement.pdf.

- Steffi Becking, et al. 2023. "Alternative Methodology for Sizing Water Pipes." *California Energy Reach Codes*. 01 10. Accessed 01 16, 2023.
<https://localenergycodes.com/content/reach-codes/energy-plus-water-1>.
- Stone, Nehemiah, J Nickelsburg, and W Yu. 2015. "New Home Cost v. Price Study."
- Stone, Nehemiah, Jerry Nickelsburg, and William Yu. 2015. *Codes and Standards White Paper: Report - New Home Cost v. Price Study*. Pacific Gas and Electric Company. Accessed February 2, 2017.
<http://docketpublic.energy.ca.gov/PublicDocuments/Migration-12-22-2015/Non-Regulatory/15-BSTD-01/TN%2075594%20April%202015%20Codes%20and%20Standards%20White%20Paper%20-%20Report%20-%20New%20Home%20Cost%20v%20Price%20Study.pdf>.
- Symmons. 2018. "TempControl 7 Series O&M Manual-Page 9." *Symmons*. 10 09. Accessed 01 16, 2023. <https://images.salsify.com/image/upload/s--Gzq0hM2v--/lwevvcttnmoaawg3hray.pdf>.
- Toritseju Omaghom, Natascha Milesi Ferretti, Gary Klein, and Steven Buchberger. 2022. "Extending the Water Demand Calculator to Commercial and Institutional Buildings." *American Society of Plumbing Engineers*. 06 15. Accessed 12 28, 2022. <https://www.aspe.org/pipeline/extending-the-water-demand-calculator-to-commercial-and-institutional-buildings/>.
- U.S. DOE . 2012. *Insulation Requirements in Commercial Buildings for Mechanical and Service Hot-Water Piping*. ANSI/ASHRAE/IES Standard 90.1-2010 & 2012 IECC, Washington D.C. : U.S. DOE .
doi:https://www.energycodes.gov/sites/default/files/documents/cn_commercial_hot_water_piping.pdf.
- U.S. DOE, EERE. 2022. "Preliminary Analysis Technical Support Document: Energy Efficiency Program For Consumer Products And Commercial And Industrial Equipment: Consumer Water Heaters." *Regulations.gov*. March.
<https://www.regulations.gov/document/EERE-2017-BT-STD-0019-0018>.
- United States Census Bureau. n.d. *Quick Facts 2019 and 2021*. Accessed September 12, 2022. United States Census Bureau
<https://data.census.gov/cedsci/table?t=Housing%20Units&g=0400000US06&tid=ACSCP5Y2020.CP04>.
- Velez, Kiki, and Merrian Borgeson. 2022. *CA Clean Buildings Progress Report: 2022*. 1 16. <https://www.nrdc.org/experts/kiki-velez/ca-progress-report-2022>.
- World Plumbing Council. 2022. *IAPMO Applauds Passage of U.S. Federal Premise Plumbing Research Legislation*. Accessed 01 04, 2023.

<https://www.worldplumbing.org/iapmo-applauds-passage-of-federal-premise-plumbing-research-legislation/>.

Young, Clair. 2010. "Armstrong International wins Industry Innovation Award." *World Pumps*. 11 18. Accessed 01 07, 2023.

<https://www.worldpumps.com/content/news/armstrong-international-wins-industry-innovation-award/>.

Appendix A: Statewide Savings Methodology

The Statewide CASE Team estimated statewide impacts for the first year by multiplying per-unit savings estimates by statewide construction forecasts that the CEC provided (California Energy Commission 2022). The CEC provided the construction estimates on March 27, 2023, at the Staff Workshop on Triennial California Energy Code Measure Proposal Template.

For Multifamily

The Statewide CASE Team followed guidance provided in the CEC’s New Measure Proposal Template (developed by the CEC) to calculate statewide energy savings using the CEC’s construction forecasts, including a request to assume a statewide weighting as follows: Low-Rise Garden (4 percent), Loaded Corridor (33 percent), Mid-Rise Mixed-Use (58 percent) and High-Rise Mixed Use (5 percent). See Section 8.3.2 of the CEC’s New Measure Proposal Template (California Energy Commission 2022). The Statewide CASE Team did not make any changes to the CEC’s construction estimates.

The Statewide CASE Team estimated statewide impacts for the first year by multiplying per-unit savings estimates by the CEC’s statewide construction forecasts. The Statewide CASE Team made assumptions about the percentage of buildings in each climate zone that would be impacted by the proposed code change. Table 374 and Table 379 through Table 382 present the number of dwelling units, both newly constructed and existing, that the Statewide CASE Team assumed would be impacted by the proposed code change during the first year the 2025 code is in effect.

Table 366 presents the prototypical buildings and weighting factors that the CEC requested the Statewide CASE Team use for each Building Type ID in the Statewide Construction Forecast.

Table 366: Multifamily Building Types and Associated Prototype Weighting

Building Type ID from Statewide Construction Forecast	Building Prototype for Energy Modeling	Weighting Factors for Statewide Impacts Analysis (percent of total annual new construction of multifamily dwelling units)
Multifamily	Low-Rise Garden	4%
	Low-Rise Loaded Corridor	33%
	Mid-Rise Mixed Use	58%
	High-Rise Mixed Use	5%

Using these weighting factors, The Statewide Case Team estimated the percentages of DHW heater fuel types by building prototype. The estimates are the result of analysis of several data source including Evergreen Economics, California Residential Appliance

Saturation Study RASS, and consultant projects collected by the Statewide CASE Team (California Energy Commission 2019). Those data were then plotted, and curve fitted to a linear profile to establish a trend line. That trend line was that extrapolated out to 2026 to determine the estimates. Table 367 presents the fuel source estimates by building prototype.

Table 367: Multifamily Building Types and Associated DWH Fuel

Building Prototype for Energy Modeling	2026 Projection Percentage of Gas	2026 Projection Percentage Electric
Low-Rise Garden	72%	28%
Low-Rise Loaded Corridor	83%	17%
Mid-Rise Mixed Use	83%	17%
High-Rise Mixed Use	86%	14%

Using these weighting factors, the Statewide Case Team also estimated the percentage of distribution system types by building prototype. The estimates are the result of analysis of several data sources. These data were averaged to estimate the overall system percentages. Table 368 presents the system type estimates.

Table 368: Multifamily Building Types DHW Distribution System Types

Building Prototype for Energy Modeling	Percentage of Central Systems	Percentage of Individual Systems
Low-Rise Garden	45%	55%
Low-Rise Loaded Corridor	65%	35%
Mid-Rise Mixed Use	66%	34%
High-Rise Mixed Use	95%	5%

The Statewide Case Team then estimated the percentages of buildings statewide that would be impacted by each proposed measure. The estimates are the result of analysis of several data sources. For the Appendix M measure, the Statewide CASE Team considered the fact that all newly constructed multifamily buildings would be impacted by this measure. Table 369 presents that impact analysis.

Table 369: Appendix M Statewide Impacts

Building Prototype for Energy Modeling	Percentage of Buildings Impacted	Number of Buildings Impacted
Low-Rise Garden	45%	1,054
Low-Rise Loaded Corridor	65%	12,764
Mid-Rise Mixed Use	66%	1,954
High-Rise Mixed Use	95%	32,619

For the Pipe Insulation measure, The Statewide Case Team considered the fact that all newly constructed multifamily buildings would be impacted by this measure. Table 370 presents that impact analysis.

Table 370: Pipe Insulation Statewide Impacts

Building Prototype for Energy Modeling	Percentage of Buildings Impacted	Number of Buildings Impacted
Low-Rise Garden	45%	1,054
Low-Rise Loaded Corridor	65%	12,764
Mid-Rise Mixed Use	66%	1,954
High-Rise Mixed Use	95%	32,619

For the Automatic Balancing Valve measure, the Statewide Case Team accounted for the estimated average percentage of buildings utilizing a central DHW system design from the Teams plans review. Based on the Statewide CASE Team’s plans data analysis, the Team found that 90 percent of projects with central systems have more than one riser in their DHW recirculation system, and that 25 percent of projects include thermal balancing valves. This measure would only impact low-rise garden style and low-rise loaded corridor buildings, regardless of fuel source. Table 371 presents that impact analysis.

Table 371: Require Automatic Balancing Valves (ABV) Statewide Impacts

Building Prototype for Energy Modeling	Percentage of Buildings Impacted	Number of Buildings Impacted
Low-Rise Garden	10%	237
Low-Rise Loaded Corridor	15%	2,872
Mid-Rise Mixed Use	NA	NA
High-Rise Mixed Use	NA	NA

For the MMV measure, The Statewide Case Team considered the estimated average percentage of buildings utilizing a central DHW system design and considered that this measure would impact all applicable buildings regardless of fuel source. Table 372 presents that impact analysis.

Table 372: Master Mixing Valve (MMV) Impacts

Building Prototype for Energy Modeling	Percentage of Buildings Impacted	Number of Buildings Impacted
Low-Rise Garden	45%	1,054
Low-Rise Loaded Corridor	65%	12,764
Mid-Rise Mixed Use	66%	1,954
High-Rise Mixed Use	95%	32,619

For the Central HPWH measure, The Statewide Case Team considered the estimated average percentage of buildings utilizing a central DHW system design and multiplied that by the 2026 estimate of buildings utilizing electricity as the DWH fuel. Table 373 presents that impact analysis.

Table 373: Central HPWH Statewide Impacts-Building Prototype for Energy Modeling

Building Prototype	Percentage of Buildings Impacted	Number of Buildings Impacted
Low-Rise Garden	13%	267
Low-Rise Loaded Corridor	11%	2201
Mid-Rise Mixed Use	11%	330
High-Rise Mixed Use	13%	4538

Table 374: Estimated New Construction and Existing Building Stock for Multifamily Buildings by Climate Zone – Central HPWH

Building Climate Zone	Total Homes Completed in 2026 (New Construction) [A]	Percent of New Buildings Impacted by Proposal [B]	New Buildings Impacted by Proposal in 2026 C = A x B	Total Existing Homes in 2026 [D]	Percent of Existing Buildings Impacted by Proposal [E]	Buildings Impacted by Proposal in 2026 F = D x E
1	144	11%	16	144	0%	0
2	1,391	11%	158	1,391	0%	0
3	7,699	11%	874	7,699	0%	0
4	3,417	11%	388	3,417	0%	0
5	285	11%	32	285	0%	0
6	2,243	11%	255	2,243	0%	0
7	5,156	11%	585	5,156	0%	0
8	8,600	11%	977	8,600	0%	0
9	10,302	11%	1,170	10,302	0%	0
10	4,306	11%	489	4,306	0%	0
11	1,173	11%	133	1,173	0%	0
12	5,537	11%	629	5,537	0%	0
13	1,009	11%	115	1,009	0%	0
14	1,446	11%	164	1,446	0%	0
15	373	11%	42	373	0%	0
16	187	11%	21	187	0%	0
TOTAL	53,268	-	6,048	53,268	-	0

For the Individual Electric Ready measure, The Statewide Case Team considered the estimated average percentage of buildings utilizing an individual DHW system design and multiplied that by the 2026 estimate of buildings utilizing natural gas as the DWH fuel. Table 375 presents that impact analysis.

Table 375: Individual Electric Ready Statewide Impacts

Building Prototype for Energy Modeling	Percentage of Buildings Impacted	Number of Buildings Impacted
Low-Rise Garden	40%	943
Low-Rise Loaded Corridor	29%	5605
Mid-Rise Mixed Use	28%	836
High-Rise Mixed Use	4%	1478

For the Central Electric Ready measure, The Statewide Case Team considered the estimated average percentage of buildings utilizing a central DHW system design and multiplied that by the 2026 estimate of buildings utilizing natural gas as the DWH fuel. Table 376 presents that impact analysis.

Table 376: Central Electric Ready Statewide Impacts

Building Prototype for Energy Modeling	Percentage of Buildings Impacted	Number of Buildings Impacted
Low-Rise Garden	32%	756
Low-Rise Loaded Corridor	54%	10,563
Mid-Rise Mixed Use	55%	1623
High-Rise Mixed Use	82%	28,082

For the Ventilation measure, with Interior Closet, The Statewide Case Team considered the estimated average percentage of buildings utilizing an individual DHW system design and multiplied that by the 2026 estimate of buildings installing individual HPWH in Interior Closet. For Exterior Closet, The Statewide Case Team considered the estimated average percentage of buildings utilizing an individual DHW system design and multiplied that by the 2026 estimate of buildings installing individual HPWH in Exterior Closet.

Table 377 and Table 378 represent the percentage distribution of statewide impacts for new constructions and additions and alterations. This measure applied to both single family building and multifamily building and both new constructions and retrofit.

Table 379 through

Table 382 present the estimated new construction and existing building stock for single family and multifamily buildings for both Exterior Closet and Interior Closet measures.

Table 377: Ventilation Statewide Impacts for New Constructions and Additions

New Construction	% of Buildings	% of Prototype Receiving Indiv. HPWH	% of HPWHs Installed in Interior Closets	% of HPWHs Installed in Exterior Closets	% of HPWHs installed in Attached Garages (Excluded from Measure)	% impact for Exterior	% impact for Interior
LowRiseGarden	4.00%	11.43%	25.00%	70.00%	5.00%	8.00%	2.86%
LoadedCorridor	33.00%	4.68%	25.00%	75.00%	0.00%	3.51%	1.17%
HighRiseMixedUse	58.00%	0.15%	100.00%	0.00%	0.00%	0.00%	0.15%
MidRiseMixedUse	5.00%	4.49%	100.00%	0.00%	0.00%	0.00%	4.49%
SF500	2.00%	35.10%	95.00%	5.00%	0.00%	1.76%	33.35%
SF2100	49.00%	35.10%	5.00%	5.00%	90.00%	1.76%	1.76%
SF2700	49.00%	35.10%	5.00%	5.00%	90.00%	1.76%	1.76%

Table 378: Ventilation Statewide Impacts for Alterations

New Construction	% of Buildings	% of Prototype Receiving Indiv. HPWH	% of HPWHs Installed in Interior Closets	% of HPWHs Installed in Exterior Closets	% of HPWHs installed in Attached Garages (Excluded from Measure)	% impact for Exterior	% impact for Interior
LowRiseGarden	40.00%	2.58%	50.00%	50.00%	5.00%	1.29%	1.29%
LoadedCorridor	18.00%	1.61%	50.00%	50.00%	0.00%	0.81%	0.81%
HighRiseMixedUse	18.00%	0.23%	97.00%	3.00%	0.00%	0.01%	0.22%
MidRiseMixedUse	24.00%	1.58%	97.00%	3.00%	0.00%	0.05%	1.53%
SF500	2.00%	3.10%	95.00%	5.00%	0.00%	0.16%	2.95%
SF2100	49.00%	3.10%	7.00%	3.00%	90.00%	0.09%	0.22%
SF2700	49.00%	3.10%	7.00%	3.00%	90.00%	0.09%	0.22%

Table 379: Estimated New Construction and Existing Building Stock for Single Family Buildings by Climate Zone – Individual HPWH Ventilation-Exterior Closet

Building Climate Zone	Total Dwelling Units Completed in 2026 (New Construction) [A]	Percent of New Dwelling Units Impacted by Proposal [B]	New Dwelling Units Impacted by Proposal in 2026 C = A x B	Total Existing Dwelling Units in 2026 [D]	Percent of Existing Dwelling Units Impacted by Proposal [E]	Dwelling Units Impacted by Proposal in 2026 F = D x E
1	359	2%	6.3	359	0%	0.3
2	1,861	2%	33	1,861	0%	2
3	3,035	2%	53	3,035	0%	3
4	2,689	2%	47	2,689	0%	3
5	616	2%	11	616	0%	1
6	1,719	2%	30	1,719	0%	2
7	1,869	2%	33	1,869	0%	2
8	4,163	2%	73	4,163	0%	4
9	4,286	2%	75	4,286	0%	4
10	7,950	2%	140	7,950	0%	7
11	5,840	2%	102	5,840	0%	5
12	14,542	2%	255	14,542	0%	14
13	7,257	2%	127	7,257	0%	7
14	3,739	2%	66	3,739	0%	4
15	3,160	2%	55	3,160	0%	3
16	1,937	2%	34	1,937	0%	2
TOTAL	65,022	-	1,141	65,022	-	61

Table 380: Estimated New Construction and Existing Building Stock for Multifamily Buildings by Climate Zone – Individual HPWH Ventilation-Exterior Closet

Building Climate Zone	Total Dwelling Units Completed in 2026 (New Construction) [A]	Percent of New Dwelling Units Impacted by Proposal [B]	New Dwelling Units Impacted by Proposal in 2026 C = A x B	Total Existing Dwelling Units in 2026 [D]	Percent of Existing Dwelling Units Impacted by Proposal [E]	Dwelling Units Impacted by Proposal in 2026 F = D x E
1	144	1%	2	144	1%	1
2	1,391	1%	21	1,391	1%	9
3	7,699	1%	114	7,699	1%	52
4	3,417	1%	51	3,417	1%	23
5	285	1%	4	285	1%	2
6	2,243	1%	33	2,243	1%	15
7	5,156	1%	76	5,156	1%	35
8	8,600	1%	127	8,600	1%	58
9	10,302	1%	152	10,302	1%	69
10	4,306	1%	64	4,306	1%	29
11	1,173	1%	17	1,173	1%	8
12	5,537	1%	82	5,537	1%	37
13	1,009	1%	15	1,009	1%	7
14	1,446	1%	21	1,446	1%	10
15	373	1%	6	373	1%	3
16	187	1%	3	187	1%	1
TOTAL	53,268	-	787	53,268	-	358

Table 381: Estimated New Construction and Existing Building Stock for Single Family Buildings by Climate Zone – Individual HPWH Ventilation-Interior Closet

Building Climate Zone	Total Dwelling Units Completed in 2026 (New Construction) [A]	Percent of New Dwelling Units Impacted by Proposal [B]	New Dwelling Units Impacted by Proposal in 2026 C = A x B	Total Existing Dwelling Units in 2026 [D]	Percent of Existing Dwelling Units Impacted by Proposal [E]	Dwelling Units Impacted by Proposal in 2026 F = D x E
1	359	2.39%	8.57	359	0.27%	0.97
2	1,861	2.39%	44.42	1,861	0.27%	5.05
3	3,035	2.39%	72.44	3,035	0.27%	8.24
4	2,689	2.39%	64.18	2,689	0.27%	7.30
5	616	2.39%	14.70	616	0.27%	1.67
6	1,719	2.39%	41.03	1,719	0.27%	4.66
7	1,869	2.39%	44.61	1,869	0.27%	5.07
8	4,163	2.39%	99.36	4,163	0.27%	11.30
9	4,286	2.39%	102.30	4,286	0.27%	11.63
10	7,950	2.39%	189.75	7,950	0.27%	21.57
11	5,840	2.39%	139.39	5,840	0.27%	15.85
12	14,542	2.39%	347.09	14,542	0.27%	39.46
13	7,257	2.39%	173.21	7,257	0.27%	19.69
14	3,739	2.39%	89.24	3,739	0.27%	10.15
15	3,160	2.39%	75.42	3,160	0.27%	8.57
16	1,937	2.39%	46.23	1,937	0.27%	5.26
TOTAL	65,022	-	1,552	65,022	-	176

Table 382: Estimated New Construction and Existing Building Stock for Multifamily Buildings by Climate Zone – Individual HPWH Ventilation-Interior Closet

Building Climate Zone	Total Dwelling Units Completed in 2026 (New Construction) [A]	Percent of New Dwelling Units Impacted by Proposal [B]	New Dwelling Units Impacted by Proposal in 2026 C = A x B	Total Existing Dwelling Units in 2026 [D]	Percent of Existing Dwelling Units Impacted by Proposal [E]	Dwelling Units Impacted by Proposal in 2026 F = D x E
1	144	3%	4	144	1%	1
2	1,391	3%	43	1,391	1%	14
3	7,699	3%	240	7,699	1%	76
4	3,417	3%	106	3,417	1%	34
5	285	3%	9	285	1%	3
6	2,243	3%	70	2,243	1%	22
7	5,156	3%	160	5,156	1%	51
8	8,600	3%	268	8,600	1%	85
9	10,302	3%	321	10,302	1%	102
10	4,306	3%	134	4,306	1%	43
11	1,173	3%	36	1,173	1%	12
12	5,537	3%	172	5,537	1%	55
13	1,009	3%	31	1,009	1%	10
14	1,446	3%	45	1,446	1%	14
15	373	3%	12	373	1%	4
16	187	3%	6	187	1%	2
TOTAL	53,268	-	1,657	4,310,108	-	528

Appendix B: Embedded Electricity in Water Methodology

The Statewide CASE Team assumed the following embedded electricity in water values: 5,440 kWh/million gallons of water for indoor water use and 3,280 kWh/million gallons for outdoor water use (SBW Consulting, Inc. 2022). Embedded electricity use for indoor water use includes electricity used for water extraction, conveyance, treatment to potable quality, water distribution, wastewater collection, and wastewater treatment. Embedded electricity for outdoor water use includes all energy uses upstream of the customer; it does not include wastewater collection or wastewater treatment. The embedded electricity values do not include on-site energy consumption associated with water usage such as is the energy required for water heating or on-site pumping.

These embedded electricity values were derived from research conducted for CPUC Rulemaking 13-12-011. The CPUC study aimed to quantify the embedded electricity savings associated with IOU incentive programs that result in water savings, and the findings represent the most up-to-date research by the CPUC on embedded energy in water throughout California (California Public Utilities Commission 2015a, California Public Utilities Commission (CPUC) 2015b). This study resulted in the Water-Energy (W-E) Calculator 1.0, which was updated in February 2022 to Version 2.0 (SBW Consulting, Inc. 2022). The CPUC analysis was limited to evaluating the embedded electricity in water and does not include embedded natural gas in water.

The CPC Appendix M measure offers water savings from the reduced volume of water in the hot water piping in non-recirculated sections, especially branch lines from the recirculation supply loop to the apartment. Water savings has been estimated for the multifamily prototype buildings in the recent reach code report and calculation methodology is detailed (Steffi Becking, et al. 2023). The water cools down in the piping between uses when sizing piping using Appendix M, thus less room-temperature water must run down the drain while waiting for hot water to arrive at the fixture. Annual dwelling unit water savings is shown in Table 383 for the four prototype buildings. This also results in associated embedded electricity savings calculated using the 5,440 kWh/million gallons parameter for indoor water use documented earlier in this section.

Table 383: Estimated Annual Water and Energy Savings Per Dwelling Unit

Building Type	In-Unit Water Savings (Gallons/Dwelling Unit/Year)	In-Unit Embedded Electricity Savings (kWh/Dwelling Unit/Year)
Low-Rise Garden Style	257	1.40
Low-Rise Loaded Corridor	320	1.74
Mid-Rise Mixed-Use	234	1.27
High-Rise Mixed-Use	248	1.35

Based on 2025 Energy Code Residential New Construction Starts the number of new construction and dwelling units are forecasted. Based on these forecasted number of buildings and the In-Unit water and embedded electricity savings values for each of the prototype buildings, total Statewide water and embedded electricity savings values are evaluated and then using the total number of dwelling units, average savings values are estimated.

Table 384: Estimated New Multi-Family Building Construction

Building Type	Number of Buildings	Number of Dwelling Units	% Central Systems	Number of DU in Central Systems	In-Unit Water Savings (Gal/DU/Yr)	In-Unit Embedded Electricity Savings (kWh/DU/Yr)	Total Gallons Saved (Gal/Yr)	Total Embedded Electricity Savings (kWh/Yr)
Low-Rise Garden Style	266	2,131	44%	938	257	1.40	240,973	1,311
Low-Rise Loaded Corridor	488	17,578	65%	11426	320	1.74	3,656,224	19,890
Mid-Rise Mixed-Use	351	30,895	66%	20393	234	1.27	4,771,887	25,959
High-Rise Mixed-Use	23	2,663	95%	2530	248	1.35	627,402	3,413
Total	1,128	53,267	66%	35,286	263	1.43	9,296,487	50,573

Appendix C: California Building Energy Code Compliance Software Specification

There are no recommended revisions to the compliance software as a result of code change proposal for individual HPWH Ventilation, Individual HPWH Electric Ready, and Central HPWH Electric Ready.

CPC Appendix M, Pipe Insulation Enhancement, Thermostatic Balancing Valves, and Master Mixing Valve

Technical Basis for Software Change

Hot water distribution systems allow hot water to be delivered from water heating and storage equipment to hot water fixtures in the building. In multifamily buildings with central domestic hot water (DHW) systems, recirculation systems are usually used for the connection between the water heating plant and hot water fixtures. Central water heating plants also include a substantial number of pipes for connection between water heating and storage equipment. Energy performance of hot water distribution systems are reflected by pipe heat loss. Recirculation system pipe heat loss represents a large fraction of total DHW system energy use (PIER 2013).

This CASE study proposed several prescriptive and mandatory requirements to reduce distribution system pipe heat loss in multifamily buildings by addressing the following technical areas:

- Insulation quality improvement
- Pipe sizing method
- Recirculation flow balancing and controls
- Require master mixing valve

The CASE study proposed changes to Alternative Calculation Method (ACM) modeling rules related to these technical areas. CBECC would need to be updated according to the related changes to ACM Reference Manual in Section 11.4.1.

Description of Software Change

Background Information for Software Change

The Statewide CASE Team proposes several efficiency measures to reduce pipe heat loss from recirculation systems in multifamily buildings. These measures aim to improve pipe insulation, reduce pipe sizes, and reduce distribution pipe temperatures by improving DHW circulation system balance and through the proper use of MMV.

Current CBECC distribution loop model assumes CPC Appendix A as the baseline design and models a 6-pipe simplified distribution model based on entering the number of dwelling units and other factors such as building type into the model. The Statewide CASE Team modeled heat loss savings from CPC Appendix M and compared it to CPC Appendix A based on pipe surface area reduction for four MF building prototypes. The energy penalty for using CPC Appendix A pipe sizing methodology is based on the pipe surface area increase and associated increase in pipe heat loss rate. The specific energy savings value depends on the user inputs for the heating plant type and configuration. Table B-6: Pipe Size Schedule for Supply Pipe Sections in Appendix B, Section B6: Water Heating Calculation Method of the *Residential ACM Reference Manual* is updated in Section 11.4.1 to reflect an energy penalty for the proposed Appendix A pipe sizing case.

The Statewide CASE Team proposes updating the existing CBECC calculation methods in the ACM Reference Manual for the hot water distribution loop for the pipe insulation enhancement proposed measure. The update is the correction factor f_{ua} in Equation 19 in Appendix B, Section B5 standard design to 2.0 with continuous pipe insulation and pipe installation quality field verification. If pipe insulation is not field verified, then f_{ua} is equal to 2.4. The existing ACM Reference Manual does not include modeling rules for pipe heat loss calculations for pipes in water heating plants. The Statewide CASE Team developed new ACM modeling rules for calculating plant pipe heat loss that can be utilized for the pipe insulation and CPC Appendix M measures. A *Water Heating Plant Pipe Heat Loss* subsection has been added to Appendix B, Section B7 *Energy Use of Water Heaters* to include Equation 45 to calculate hourly pipe heat loss of water heating plant (HPPL_k). This heating plant pipe heat loss value HPPL_k is added to Equation 3 in Appendix B, Section B4 to solve for the hourly adjusted recovery load of the centralized water heating system.

The MMV measure improves heating plant efficiency in many cases through improved tank water temperature stratification. The Statewide CASE Team developed ACM modeling assumptions for the standard design with MMV and proposed design with no MMV based on lab testing of HPWH systems at PG&E ATS hot water system laboratory, as described in Appendix Q. The modelling assumptions are included in Section 11.4.1 for the Nonresidential and Multifamily Alternative Calculation Method Reference Manual, including a new Section 6.11.3 subsection for Master Mixing Valve. In Section 11.4.1, Table 43 and 44 provide correction factors for HPWH systems and gas-fired water heating systems, respectively, with either a digital or mechanical MMV standard design or no MMV proposed design.

The Statewide CASE Team recommends that CBECC be updated accordingly to the proposed changes to ACM modeling rules for hot water distribution systems to support

the implementation of the proposed prescriptive and mandatory requirements on central hot water distribution systems.

Existing CBECC Building Energy Modeling Capabilities

Existing ACM Reference Manuals provide a comprehensive set of modeling rules for calculating recirculation system pipe heat loss. These existing ACM modeling rules have been incorporated into CBECC.

Summary of Proposed Revisions to CBECC

The Statewide CASE Team recommends the following revisions to CBECC:

- Update modeling inputs related to pipe insulation quality, pipe surface area, and recirculation flow rate for both the standard design and proposed designs.
- Add modeling capability to calculate water heating plant pipe heat loss.
- Add modeling capability to calculate additional energy use when not designing with a MMV for centralized DHW system based on hot water system configuration type with continuous recirculation.
- Add modeling capability to calculate the energy savings when using TBV. Modify the recirculation flow rate to calculate energy savings associated with reduced recirculation flow. See ACM Section 11.4.1 for the proposed algorithm.
- Add three new input fields as described below.

User Inputs to CBECC

The Statewide CASE Team recommends that the following three (3) user input fields be added to CBECC software, to specify if:

- recirculation and water heating plant pipes are sized based on the CPC Appendix M.
- thermal balancing valves and a variable-speed recirculation pump are specified in the recirculation system with settings to achieve 120°F or lower at these balancing valves, in accordance with RA 4.4.3.
- a digital MMV is specified, and installation schematic provided.

Detailed specifications of these user input fields are provided in Table 385. Existing CBECC includes a user input field to specify if pipe insulation has been verified through field inspection by a HERS rater.

Table 385: Additional User Inputs Relevant to the Water Heating System

Input Screen	Variable Name	Data Type	Units	User Editable	Recommended Label
DHW Res/ DHW System Data	PipeSize_UPC AppendixM	Boolean	None	Yes	Are hot water pipes sized according to CPC Appendix M?
DHW Res/ Recirculation Loop	BalancingValve_Thermal	Boolean	None	Yes	Are thermal balancing valves and a variable-speed pump installed and configured in accordance with RA 4.4.3 to achieve no more than 120°F at thermostatic balancing valves?
DHW Res/ DHW System Data	MasterMixing Valve	Boolean	None	Yes	Is there a MMV installed per section 170.2(d)?

Simulation Engine Inputs

EnergyPlus/California Simulation Engine Inputs

The proposed ACM language describes the modeling assumptions to be used for the corresponding user input field. The Statewide CASE Team recommends that the related modeling assumptions be incorporated into California Simulation Engine according to the corresponding user input value.

No changes to EnergyPlus are required.

Calculated Values, Fixed Values, and Limitations

See Section 11.4 ACM Reference Manual for equations and assumption values for the proposed changes to CBECC software.

Alternate Configurations

Alternate configurations for the three proposals are listed below:

- Pipe insulation field inspection and verification: users can choose the option of not having the insulation of recirculation and water heating plant pipes be verified by a HERS rater through field inspection and receive an energy penalty.
- Pipe sizing: recirculation and water heating plant pipes may be sized according to CPC Appendix A, instead of Appendix M and receive an energy penalty.
- Balancing valves: Credit is only given when all proposal criteria are met.

- Master Mixing Valves: users can select not to specify a digital MMV and would not receive a credit.

Simulation Engine Output Variables

No changes to simulation engine output variables are needed to support the implementation of measures proposed by this CASE study.

Compliance Report

Compliance Verification

Testing and Confirming CBECC Building Energy Modeling

DHW system energy consumption calculated by CBECC for the Standard Design and proposed design options should be tested to confirm that changes to the related ACM modeling rules are properly implemented. Table 386 provides the design options that should be tested. These design options should be tested for all four multifamily prototype buildings.

The Statewide CASE would provide expected DHW system energy consumption for verifying CBECC calculation results according to the adopted standard requirements and related changes to the Nonresidential and Multifamily ACM Reference Manual.

Table 386: Percentage of Nonresidential Floorspace Impacted by Proposed Measure, by Climate Zone

Design Options	Pipe Insulation Field Verified	Pipes Sized Based on UPC Appendix M	Thermostatic Balancing Valves and a Variable-Speed Pump installed	MMV Installed
The Standard Design	Yes	Yes	Yes	Yes
Proposed Design 1: Pipe insulation not field verified	No	Yes	Yes	Yes
Proposed Design 2: Pipes not sized based on UPC Appendix M	Yes	No	Yes	Yes
Proposed Design 3: Thermostatic balancing valves or a variable speed pump not installed	Yes	Yes	No	Yes
Proposed Design 4: Digital MMV not installed	Yes	Yes	Yes	No

Description of Changes to ACM Reference Manual

Proposed changes to the ACM Manual are listed below:

- Equation 16 is slightly modified to include a factor that indicates whether TBV are used that meet the criteria of RA 4.4.3 for compliance credit. For the standard design (no TBV), the new factor is 1. If the criteria of RA 4.4.3 is met, the new factor is 0.6.

Central HPWH Clean-up

Changes to the CBECC Software

This section presents proposed revisions to CBECC for residential buildings. The CBECC software already has the capability to model most common central HPWH plumbing configurations discussed in Section 7.2.2. Below is a summary of changes to the software incurred by this code change proposal:

- User Inputs: no change
- Simulation engine inputs: no change
- Simulation engine output variables: The proposal would require compliance software output of central HPWH system COP.
- Compliance report: The compliance report would include a field for central HPWH system COP.
- Compliance verification:

Description of Changes to ACM Reference Manual

There are no recommended revisions to the ACM.

Individual HPWH Ventilation

Changes to the CBECC Software

This section presents proposed revisions to CBECC for residential buildings. The CBECC software already has the capability to model individual HPWHs. Below is a summary of changes to the software incurred by this code change proposal:

- User Inputs: When any individual HPWH is included in the design, the software would require the designer to check a box that states the mandatory ventilation requirements are met by the design.
- Simulation engine inputs: No change.
- Simulation engine output variables: No change.

- Compliance report: When any individual HPWH is included in the design, the compliance report would list “HPWH ventilation (larger of either mandatory minimum or manufacturer specification) installed” under Required Special Features.
- Compliance Verification: No change.

Description of Changes to ACM Reference Manual

There are no recommended revisions to the ACM.

Appendix D: Environmental Analysis

This section discusses the potential environmental impacts of the proposed measures.

Potential Significant Environmental Effect of Proposal

The CEC is the lead agency under the California Environmental Quality Act (CEQA) for the 2025 Energy Code and must evaluate any potential significant environmental effects resulting from the proposed standards. A “significant effect on the environment” is “a substantial adverse change in the physical conditions which exist in the area affected by the proposed project.” (Cal. Code Regs., tit. 14, § 15002(g).)

The Statewide CASE Team has considered the environmental benefits and adverse impacts of its proposal including, but not limited to, an evaluation of factors contained in the California Code of Regulations, Title 14, section 15064 and determined that the proposal would not result in a significant effect on the environment.

Direct Environmental Impacts

Direct Environmental Benefits

The proposed measures would directly benefit the environment through energy savings due to a more efficient DHW heater system distribution design, such as smaller pipe sizing, enhanced pipe insulation, requirement of MMVs, and promoting thermal balancing valves. The Appendix M measure leads to pipe diameter reduction and results in lower embodied carbon for the pipe, fitting, appurtenance, and insulation materials for the distribution piping and would beneficially impact the environment. The smaller pipe size, enhanced insulation and MMV reduces heat loss through the distribution piping. The balancing valve measure improves the delivery performance of the hot water distribution system and reduces the hot water return temperatures, which lowers the distribution system heat loss. The MMV more accurately controls the water flow temperature to the desired temperature based on fluctuating hot water demand and ensures that the majority of recirculation return water returns to the mixing valve and bypasses the storage tank to improve water temperature stratification in the primary storage tank or temperature maintenance tank for improved operating efficiency at the heating plant. The reduction in energy use would result in less GHG emissions and other pollutions. The energy and GHG emissions impacts are detailed in the Statewide Energy and Cost Savings sections and the Statewide GHG Emissions Reduction sections for each measure.

The proposed measures would directly benefit the environment through energy savings due to the electrification of fossil fuel or gas DHW heaters to HPWHs. HPWH systems are more energy efficient than a fossil fuel or gas water heating system as they do not generate heat

directly but use electricity to produce hot water by transferring heat. The reduction in energy use would result in less GHG emissions and other pollutions. Electrification also would offset the CO₂ emissions generated from fossil fuel and gas. The energy and GHG emissions impacts are detailed in the Statewide Energy and Cost Savings sections and the Statewide GHG Emissions Reduction sections for each measure.

Direct Adverse Environmental Impacts

The use of valves and insulation materials would adversely impact the environment and result in greater embodied carbon, which constitutes a considerable portion of a building's GHG emissions with the pipe insulation enhancement and MMV measures. The balancing valve measure leads to embodied carbon offset with smaller variable speed pumps utilized in the proposed measure, but that include controls and central processing units with slightly larger thermal balancing valves versus larger pumps and manual balancing valves with the base case. The embodied GHG emissions from the materials used for the proposed measures are found in the Statewide Material Impacts sections.

The increased usage of certain materials, such as steel and refrigerant, would adversely impact the environment and result in greater embodied carbon, which constitutes a considerable portion of a building's GHG emissions. The embodied GHG emissions from the materials used for the proposed measures are found in the Statewide Material Impacts sections.

Indirect Environmental Impacts

Indirect Environmental Benefits

The Statewide CASE Team has determined that the proposal would result in reduced waste in a DHW distribution system. Avoiding oversized pipes and selecting a smaller pipe size based on the CPC Appendix M requirement would minimize the loss of water and energy. Decreasing the pipe diameter would reduce the volume of water in the pipes between the hot water source and each fixture. Also, the other DHW distribution sub-measures, such as the enhanced insulation and valves, would further reduce the amount of heat loss. The hot water temperature in the pipes would be maintained, reducing the need for a higher temperature setpoint.

The Statewide CASE Team has determined that the proposal would result in reduced fossil fuel and gas usage and would reduce the outdoor air pollution, such nitrogen oxides (NO_x) and fine particulates PM_{2.5}) associated with generating combustion gases.

Indirect Adverse Environmental Impacts

The primarily adverse impact would be the increased installation of HPWHs with refrigerants, which could lead to refrigerant leaks. Refrigerant could leak from the

HPWH into the atmosphere over the course of the equipment's lifetime. Refrigerant leakage could also result from faulty or poorly maintained equipment or improper equipment disposal. This would result in increased GHG emissions. However, as the air quality standards in California become more stringent, the use of high-GWP refrigerants is being phased out and replaced with low-GWP refrigerants, which still impact the GHG emissions but are less harmful to the environment.

Mitigation Measures

The Statewide CASE Team has considered opportunities to minimize the environmental impact of the proposal, including an evaluation of "specific economic, environmental, legal, social, and technological factors." (Cal. Code Regs., tit. 14, § 15021.)

The Statewide CASE Team determined this measure would result in significant direct and/or indirect adverse environmental impacts and has developed the following mitigation measures:

- Install HPWHs with zero ozone depletion potential and low GWP or CO₂ refrigerants to reduce GHG emissions.
- Lower the refrigeration leak rates of the HPWH system by implementing a leak-detection system to ensure the system is free of leakage.

Reasonable Alternatives to Proposal

The Statewide CASE Team has considered alternatives to the proposal and believes that no alternative achieves the purpose of the proposal with less environmental effect. Other alternatives have not been considered because there are benefits associated energy savings from the proposed measures.

Water Use and Water Quality Impacts Methodology

The Statewide CASE Team has determined that the proposal would not significantly impact water use or water quality. The pipe size reductions resulting from the CPC Appendix M measure may improve the water quality due to the shorter dwell times, reducing associated health risks.

Embodied Carbon in Materials

Accounting for embodied carbon emissions is important for understanding the full picture of a proposed code change's environmental impacts. The embodied carbon in materials analysis accounts specifically for emissions produced during the "cradle-to-gate" phase: emissions produced from material extraction, manufacturing, and transportation. Understanding these emissions ensures the proposed measure

considers these early stages of materials production and manufacturing instead of emissions reductions from energy efficiency alone.

The Statewide CASE Team calculated emissions impacts associated with embodied carbon from the change in materials as a result of the proposed measures. The calculation builds off the materials impacts outlined in the Statewide Materials Impacts for each measure, see sections for more details on the materials impact analysis.

After calculating the materials impacts, the Statewide CASE Team applied average embodied carbon emissions for each material. The embodied carbon emissions are based on industry-wide environmental product declarations (EPDs).^{116, 117} These industry-wide EPDs provide GWP values per weight of specific materials.¹¹⁸ The Statewide CASE Team chose the industry-wide average for GWP values in the EPDs because the materials accounted for in the statewide calculation would have a range of embodied carbon. That is, some materials like concrete have a wide range of embodied carbon depending on the manufacturer's processes, source of the materials, etc. The Statewide CASE Team assumes that most building projects would not specify low embodied carbon products. Therefore, an average is appropriate for a statewide estimate.

First year statewide impacts per material (in pounds) were multiplied by the GWP impacts for each material. This provides the total statewide embodied carbon impact for each material. If a material's use is increased, then there is an increase in embodied carbon impacts (additional emissions). If a material's use is decreased, then there is a decrease in embodied carbon impacts (emissions reduced). Table 387 presents estimated GHG emissions impacts associated with embodied carbon from building constructed in the first year.

A comprehensive accounting of buildings' GHG emissions would include operational emissions (e.g., emissions from energy use) and embodied carbon. Title 24, Part 6 addresses energy use in buildings and results in reductions in operational GHG

¹¹⁶ EPDs are documents which disclose a variety of environmental impacts, including embodied carbon emissions. These documents are based on lifecycle assessments on specific products and materials. Industry-wide EPDs disclose environmental impacts for one product for all (or most) manufacturers in a specified area and are often developed through the coordination of multiple manufacturers and/or associations. A manufacturer specific EPD only examines one product from one manufacturer. Therefore, an industry-wide EPD discloses all the environmental impacts from the entire industry (for a specific product/material) but a manufacturer specific EPD only factors one manufacturer.

¹¹⁷ An industry wide EPD was not used for mercury, lead, copper, plastics, and refrigerants. GWP values of mercury, lead and copper are based on data provided in a Lifecycle Assessment (LCA) conducted by Yale University in 2014. The GWP value for plastic is based on a LCA conducted by Franklin Associates, which capture roughly 59 percent of the U.S.' total production of PVC and HDPE production. The GWP values for refrigerants are based on data provided by the Intergovernmental Panel on Climate Change (IPCC) Fourth Assessment Report.

¹¹⁸ GWP values for concrete and wood were in units of kg CO₂ equivalent by volume of the material rather than by weight. An average density of each material was used to convert volume to weight.

emissions. The Statewide CASE Team has provided embodied carbon impacts of the proposed code changes, which could support an informed dialogue on how operational emissions and embodied emissions be considered together in the future. The information provided in this report is an incomplete accounting of whole-building embodied carbon and does not account for interactive effects that the proposal may have on other elements of the building design or material use. There may be instances where a specific system or component may increase emissions through embodied carbon but enable the building as a whole to have lower total emissions (operational plus building-wide embodied carbon).

Table 387: First Year Statewide Embodied Carbon Emissions Impacts

Proposal	Material	Impact	Annual Statewide Impacts (Pounds)	Embodied GHG emissions saved (Metric Tons CO ₂ e)
HPWH-Appendix M	Copper	Decrease	512,165	662
	Insulation	Decrease	2,900,074	3,219
	Subtotal	-	-	3,881
Gas-Appendix M	Copper	Decrease	528,158	671
	Insulation	Decrease	2,947,303	3,272
	Subtotal	-	-	3,942
HPWH Plant	Insulation	Increase	1,124,516	(1,248)
	Subtotal	-	-	(1,248)
Gas Water Heater Plant	Insulation	Increase	1,151,248	(1,278)
	Subtotal	-	-	(1,278)
Thermostatic Balancing Valves	Lead	Decrease	8	0
	Copper	Decrease	68	0
	Steel	Decrease	598	0
	Plastic	Decrease	47	0
	Brass	Increase	644	(4.42)
	Subtotal	-	-	(3.96)
Master Mixing Valves	Lead	Increase	108	0
	Copper	Increase	66,228	(84)
	Subtotal	-	-	(84)
Individual HPWH Ventilation	Steel	Increase	43,363	(23.85)
	Subtotal	-	43,363	(23.85)
Individual DHW Electric Ready	Steel	Increase	27,085	(15)
	Wood	Increase	496,448	(99)
	Gypsum	Increase	1,249,999	Not calculated
	Subtotal	-	-	(114)
All Proposals	Copper	Decrease	974,087	1,249.00
	Insulation	Decrease	3,571,613	3,965.00
	Lead	Increase	100	(8.38)
	Steel	Increase	69,850	(38.85)
	Plastic	Decrease	47	-
	Brass	Increase	644	(4.42)
	Wood	Increase	496,448	(99)
	Gypsum	Increase	1,249,999	Not calculated
	Total	-	-	5,063.35

Appendix E: Discussion of Impacts of Compliance Process on Market Actors

This appendix discusses how the recommended compliance process, which is described in Section 7.1.5, Section 8.1.5, Section 9.1.5, and Section 10.1.5, could impact various market actors. Table 388 to Table 395 identify the market actors who will play a role in complying with the proposed change, the tasks for which they are responsible, how the proposed code change could impact their existing workflow, and ways negative impacts could be mitigated. Appendix F summarizes the stakeholder engagement that the Statewide CASE Team conducted when developing and refining the code change proposal, including gathering information on the compliance process.

The compliance process for central HPWH systems and HPWH Ventilation requires a higher degree of design engineer and energy consultant coordination during design phase, closer contractor adherence to the design details during installation, and continued oversight from design engineers throughout and after installation, compared to a similar gas-fired system. Incorporating the proposed code changes for central HPWH systems and HPWH Ventilations would provide the minimum requirements to ensure safety, reliability, and performance of heat pump water heating systems.

The compliance process for individual and central DHW electric ready requires new coordination activities in the design and construction phases and requires new inspection and plan checking activities. Compliance forms can be used to reduce the burden on the building official and building inspector, while ensuring the proposal is properly enforced. The compliance and enforcement activities are especially important for this proposal since the electric ready infrastructure won't affect the performance of the hot water system until the gas water heater is replaced with a HPWH.

Table 388: Roles of Market Actors in CPC Appendix M Pipe Sizing

Market Actor	Task(s) in current compliance process relating to the CASE measure	How will the proposed measure impact the current task(s) or workflow?	How will the proposed code change impact compliance and enforcement?	Opportunities to minimize negative impacts of compliance requirement
Plumbing Designer	<ul style="list-style-type: none"> • Would perform pipe sizing calculations and design tasks based on CPC Appendix A method • Would populate detailed piping schedule per the Appendix M sizing methodology • Would submit the permit application package to the enforcement agency 	<ul style="list-style-type: none"> • Minor change due to using Appendix M • Additional information is needed on the LMCC/NRCC-PLB form to indicate that Appendix M is being used 	Additional design documentation is needed for compliance verification	Training and spreadsheet templates and macros to integrate the IAPMO WDC spreadsheet into a larger pipe sizing spreadsheet would reduce errors and develop a comprehensive approach that designers could adopt. Appendix M specific software may be developed to complete all analysis and compliance forms seamlessly.
Energy Consultant	<ul style="list-style-type: none"> • Currently not involved in pipe sizing calculation • Would assist building designer by providing energy compliance documentation to determine the effect of building features being proposed for the design and to include correct pipe sizing • Would prepare LMCC/NRCC compliance documentation 	Now, energy consultant would need to coordinate with plumbing designer to verify what pipe sizing method was used and fill out the compliance forms appropriately	Additional design documentation is needed for compliance verification	<ul style="list-style-type: none"> • Appendix M specific software may be developed to complete all analysis and compliance forms seamlessly, training would be needed to verify it is done correctly in collaboration with designer • Verify with plumbing designer that calculations have been completed and pipe sizes meet requirements
Plans Examiner	Review Appendix A pipe sizing tables, drawings, and calculations on building plans	<ul style="list-style-type: none"> • Review Appendix A or M sizing tables, drawings, and calculations on building plans • Compare pipe sizes in IAPMO spreadsheet to pipe sizes specified on construction documents 	This is one more portion of the compliance documents that needs to be reviewed, and plan review would only slightly change	Training to ensure all staff are aware of the changes to code requirements and how that may slightly change their plans examination process

Pipe Insulation Enhancement

Pipe insulation enhancement is a combination of two measures including field verification and code language cleanup. The first part of this proposed measure updates unclear mandatory pipe insulation language for multifamily DHW distribution piping to align pipe insulation requirements for all multifamily buildings. This will help provide clarity and consistency to the design and build industry to ensure heating plants, recirculation loops, and branch piping are insulated uniformly to minimize pipe heat loss. This measure provides additional work for the construction industry, reduces the need for a designer to provide custom specifications on plan drawings and reduces confusion for the construction industry and city permitting and inspection community. Clearer pipe insulation language and uniform insulation requirements will streamline the field verification process.

The second part of this proposed measure is a prescriptive pipe insulation verification requirement that builds on an existing pipe insulation compliance credit available only to single family and low-rise multifamily buildings. It requires field verification of pipe insulation quality for DHW recirculation piping. The scale and required coverage in verifying multifamily DHW pipe insulation adds time and complexity to the construction and installation process. Multiple verification visits may be needed as plumbing insulation is often phased with other trades on site, particularly for larger buildings. HERS Raters or ATTs would require initial training to familiarize themselves with verification procedures and scope. Management of the proposed compliance forms and data registry follows existing protocols.

Table 389: Roles of Market Actors in Pipe Insulation Enhancement

Market Actor	Task(s) in current compliance process relating to the CASE measure	How will the proposed measure impact the current task(s) or workflow?	How will the proposed code change impact compliance and enforcement?	Opportunities to minimize negative impacts of compliance requirement
Plumbing Designer	<ul style="list-style-type: none"> • Would list on plans existing code requirements explicitly or reference section in code • Would add custom requirements, instruction, supporting sketches, and specifications in general notes or in insulation schedule • Would submit the permit application package to the enforcement agency 	<ul style="list-style-type: none"> • Would simplify their workflow • Reduces time spent on communication with the construction team for questions to clarify a more limited set of custom requirements • Would review LMCC/NRCC compliance documentation to verify design meets code requirements 	No significant impact	Trainings and resources could be provided to describe pipe insulation code requirements and verification process.
Energy Consultant	<ul style="list-style-type: none"> • Would make the verification selection (Y/N) in the compliance software if taking the performance path • Would prepare LMCC/NRCC compliance documentation 	No significant impact	No significant impact	No significant impact
Plans Examiner	Review Pipe insulation requirements, and schematics on building plans	<ul style="list-style-type: none"> • Review extended list of pipe insulation requirements and schematics • Compare plans to new section in the LMCC/NRCC compliance form 	This is one more portion of the compliance documents that needs to be reviewed, and plan review process would only slightly be additionally burdened	Training to ensure all staff are aware of the changes to code requirements and how that may slightly change their plans examination process
General Contractor	Would manage pipe insulation installation per design requirements in the plans and ensure it passes inspection	<ul style="list-style-type: none"> • The scale and required coverage would add time and complexity to the construction and installation process • Would complete LMCI/NRCI compliance and verification documentation to verify design meets code requirements and prepare for HERS verification • Would need additional coordination for timing and scheduling the HERS Rater or ATT for insulation verification 	Additional coordination with HERS inspector for insulation verification	Trainings and resources could be provided to describe pipe insulation code requirements and verification process

Market Actor	Task(s) in current compliance process relating to the CASE measure	How will the proposed measure impact the current task(s) or workflow?	How will the proposed code change impact compliance and enforcement?	Opportunities to minimize negative impacts of compliance requirement
Plumbing Contractor	Would review plans and adjust practices to allow clearance for pipe insulation installation and follow instructions for pipe supports if provided	The scale and required coverage of appurtenances would add time and complexity to the construction and installation process	No significant impact	Trainings and resources could be provided to describe pipe support requirements and ensure plumbers are aware of how pipe insulation requirements impact pipe installation practices.
Insulation Contractor	Would come on site to provide takeoffs and quote for installation after review of plans to ensure the estimate for pipe insulation procurement and installation meets code requirements and custom design requirements	<ul style="list-style-type: none"> • The scale and required coverage would add time, extra insulation materials and complexity to the construction and installation process • It would save time and improve installation quality as clear explicit code requirements would commoditize insulation installation process 	No significant impact	Trainings and resources could be provided to describe revised pipe insulation code requirements and add training for installation best practices.
HERS Rater	<ul style="list-style-type: none"> • Would coordinate testing schedule with contractors • Would prepare and submit LMCV/NRCV compliance documentation 	Multiple verification visits may be needed as plumbing insulation would be phased with other trades on site for large sites. At the same time, the larger the site means that multiple visits are required to also inspect other building system components thus visits can be combined to serve multiple needs.	Additional coordination with contractor or general contractor for insulation verification	Would require initial training for verification procedures
Inspector	Review of pipe insulation installation to ensure recirculation loop piping and at the heating plant are insulated for straight pipe and fittings	Review of compliance and verification forms and more detailed inspection of accessible pipe insulation	HERS verification assures installation is completed correctly, reduces the work of the inspector to review in detail.	No significant impact

Table 390: Roles of Market Actors in Require Balancing Valves

Market Actor	Task(s) in current compliance process relating to the CASE measure	How will the proposed measure impact the current task(s) or workflow?	How will the proposed code change impact compliance and enforcement?	Opportunities to minimize negative impacts of compliance requirement
Plumbing Engineer	<ul style="list-style-type: none"> • Would specify the balancing valve product, the balancing valve temperature set point, and the variable speed circulation system pump • Would coordinate relevant details to the energy consultant to support LMCC/NRCC compliance documentation 	Designers need to develop expertise in the new products	Increased coordination would be required with the energy compliance professional	Increased training offerings by automatic balancing valve manufacturers and distributors
Energy Consultant	<ul style="list-style-type: none"> • Would coordinate with the plumbing engineer and add content to the LMCC/NRCC documents based on project details • Would select the correct balancing valve type, recirculation pump type, and circulation riser set point inputs for performance approach 	Would increase the workload of the energy consultant due to the new software inputs and the need to learn about new valves	<ul style="list-style-type: none"> • Building modeling software would need to be updated to include inputs describing the proposed requirements • The applicable LMCC/NRCC compliance forms would need to be updated to reflect the proposed requirements 	NA [training?]
Plans Examiner	Would verify the specified distribution system meets the code requirements	Would increase the workload of the plans examiner since they will now need to verify the balancing valve product specifications and temperature set point, and verify that variable speed pumps are specified	No significant impact	Compliance forms could be used to reduce the burden on the inspector while ensuring the proposal is properly enforced
Installation Contractor	Would install the specified products and complete the LMCI/NRCI compliance forms	Would decrease the workload to properly install the balancing valves, but increase workload required to fill out the LMCI/NRCI forms	The applicable LMCI/NRCI compliance forms would need to be updated to reflect the proposed requirements	NA
Inspector	Would verify the installed distribution system meets the code requirements	Would increase the workload of the inspector since they will now need to verify that the installed balancing valve and variable speed pump products meet code	No significant impact	Compliance forms could be used to reduce the burden on the inspector while ensuring the proposal is properly enforced

Table 391: Roles of Market Actors in MMVs

Market Actor	Task(s) in current compliance process relating to the CASE measure	How will the proposed measure impact the current task(s) or workflow?	How will the proposed code change impact compliance and enforcement?	Opportunities to minimize negative impacts of compliance requirement
Plumbing Designer	<ul style="list-style-type: none"> • Currently no code requirement for MMVs, but specifying their use is standard practice. May follow industry standards for sizing to calculate maximum hot water flow rate to specify MMV size based on pressure loss/flow rate table and their experience. • Would use LMCC/NRCC compliance documentation to verify design meets code requirements • Would confirm the accuracy of energy compliance documentation • Would submit the permit application package to enforcement agency 	<ul style="list-style-type: none"> • If selecting a mechanical MMV, must select a unit with temperature creep mitigation built in and provide specification table, drawing and installation instructions, and/or provide sketch and instructions with standard valve to construct mitigation on site. • Would need to document compliance and optional performance credit with the new MMV requirements. • Temperature creep mitigation adds incremental cost to mechanical MMV specification. 	No significant impact	Trainings and resources about MMV requirements and options and requirements for temperature creep mitigation.
Energy Consultant	Would complete LMCC/NRCC compliance documentation	<ul style="list-style-type: none"> • Would document the MMV in the LMCC/NRCC compliance document and ensure it meets code requirements • If adding digital MMV and taking performance path, PFR compliance forms would be completed 	No significant impact	Training on MMV options, installation, commissioning, and operation
Plans Examiner	Would ensure MMV specification and setpoints meets CPC requirements to prevent scalding	Would need to verify that the LMCC/LMCI forms and optional PRF form matches the permit drawings and code	No significant impact	Training on MMV requirements and options for meeting mandatory code and compliance credit.
Installation Contractor	<ul style="list-style-type: none"> • Would typically install and commission MMV per designer specification and instructions • Would complete LMCI/NRCC compliance forms 	Would need to indicate in LMCI/NRCC that a MMV was installed and commissioned to meet code requirements	No significant impact	Training on MMV requirements and options for meeting mandatory code and compliance credit.
Inspector	Reviews documentation and installation to ensure hot water distribution system mitigates pathogen and scalding risks.	Would need to verify completion of correct valve, final installation, and programming/start up indicated on permit plans	No significant impact	Training on MMV requirements and options for meeting mandatory code and compliance credit.

Table 392: Roles of Market Actors in Central HPWH Requirements

Market Actor	Task(s) in current compliance process relating to the CASE measure	How will the proposed measure impact the current task(s) or workflow?	How will the proposed code change impact compliance and enforcement?	Opportunities to minimize negative impacts of compliance requirement
<p>Plumbing and Mechanical Designer/Plumbing Engineer</p>	<ul style="list-style-type: none"> • Would specify HPWH equipment and recirculation system following best practice and manufacture guidelines • Design drawings would show additional design features and details for ventilation and condensate pipe • Decide central HPWH system configurations • Would consider energy performance, cost, specify space footprint, clearance, and structural support for large storage tanks • Would coordinate with energy consultant to model the central HPWH system via compliance software. • Would provide modeling inputs for the central HPWH system in the compliance software and information on design in Certificate of Compliance documents • Would provide modeling inputs in the compliance software and system information for compliance documents 	<ul style="list-style-type: none"> • Design process is similar to current practice for central HPWH systems • Would estimate recirculation loop loss to assist sizing the recirculation loop tank heating capacity (this step is often overlooked) • Would size and specify storage tanks • Closely coordinate with energy consultant during design phase to ensure the proposed design is meeting minimum efficiency • Would closely oversee the installation process • Would perform the same task when designing gas or central HPWH system as before, but with added modeling capacity to compliance software, would make more informed decisions for a wide range of configurations 	<p>Design drawings would show additional design features and details for ventilation requirements and condensate pipe</p>	<p>No significant impact</p>
<p>Structural Engineer</p>	<p>Design for structural requirements of HPWH system would include additional weight requirements for tanks.</p>	<p>No significant impact</p>	<p>No significant impact</p>	<p>No significant impact</p>
<p>Plans Examiner</p>	<ul style="list-style-type: none"> • Would perform plan check reviews on system layout, and verify the building adheres to performance budget or is designed according to prescriptive standards • Would understand the central HPWH requirements 	<p>Would check for system efficiency, specific design features all meet installation criteria</p>	<p>No significant impact</p>	<p>Additional training on central HPWH systems would be needed</p>

Market Actor	Task(s) in current compliance process relating to the CASE measure	How will the proposed measure impact the current task(s) or workflow?	How will the proposed code change impact compliance and enforcement?	Opportunities to minimize negative impacts of compliance requirement
Energy Consultant	<ul style="list-style-type: none"> • Would coordinate with design engineers to model the central HPWH system via compliance software • Would prepare Title 24 compliance documentation 	Closely coordinate with plumbing designer during design phase to ensure the proposed design is meeting minimum efficiency	No significant impact	No significant impact
Plumbing Contractor	<ul style="list-style-type: none"> • Would install the central HPWH system including heat pump, storage tanks, plumbing components, and specialties including mixed valves and control sensors – as designed and per manufacturer instruction • Would populate LMCI/NRCI form and schedule on site verifications 	Closely adhere to design details during installation	No significant impact	No significant impact
Commissioning Agent	Either a design engineering team member or a contracted third party would perform the necessary commissioning testing to ensure system and controls are installed and function as designed	No significant impact	No significant impact	No significant impact
ATT/ HERS Rater	<ul style="list-style-type: none"> • Perform on site verification to ensure equipment, system design, piping configurations, space requirements, and controls are in alignment with submitted plans, meet code requirements and function as designed • Submit LMCV/NRCV forms accordingly 	No significant impact	No significant impact	No significant impact

Table 393: Roles of Market Actors in Individual HPWH Ventilation

Market Actor	Task(s) in current compliance process relating to the CASE measure	How will the proposed measure impact the current task(s) or workflow?	How will the proposed code change impact compliance and enforcement?	Opportunities to minimize negative impacts of compliance requirement
Designer	<ul style="list-style-type: none"> • Would consider individual HPWH ventilation requirements when producing the design • Ducting units is most common practice. • Innovative design practices may be incorporated. • Would include rated efficiency in equipment schedule. • Could use novel ventilation methods if certified by the HPWH manufacturer and approved by the enforcement agency • If using a novel compliance pathway, would work with manufacturers and obtain certification and confirm the design provides acceptable performance for the HPWH model • Would include manufacturer’s certification in permit application 	<p>Would need to understand proposed mandatory ventilation requirements and provide design that meet the requirement</p>	<ul style="list-style-type: none"> • Innovative design practices require certification from equipment manufacturer which would be included in design plans. • Include reference to the applicable code section in design plans. 	<ul style="list-style-type: none"> • Compliance Manuals would include examples for designers to reference • Designers would be able to reference the code requirements in designs
Plans Examiner	<ul style="list-style-type: none"> • If design includes innovative practices, would ensure design documents include manufacturer approval and applicable code section. • Would consider ventilation requirements during review process • Applicants could use novel ventilation methods if certified by the HPWH manufacturer 	<p>No significant impact.</p>	<p>If novel ventilations methods are being used, manufacturer certification is included in the permit application</p>	<p>Compliance manuals would include examples for reviewers to reference</p>
Energy Consultant	<p>Would work with designers to model HPWH rated efficiency</p>	<p>Would work with designers to understand HPWH ventilation approach and prepare Title 24 compliance documentation accordingly.</p>	<p>No significant impact</p>	<p>No significant impact.</p>

Market Actor	Task(s) in current compliance process relating to the CASE measure	How will the proposed measure impact the current task(s) or workflow?	How will the proposed code change impact compliance and enforcement?	Opportunities to minimize negative impacts of compliance requirement
Contractor	<ul style="list-style-type: none"> • Would install the HPWH ventilation system as designed and per manufacturer instruction. • Would ensure ventilation requirements are being met when installing the HPWH • Would populate applicable LMCI/ NRCI forms and schedule on site verifications. 	No significant impact.	No significant impact.	Compliance manuals would include examples for contractors to reference and recommendations for installation methods to ease compliance (e.g., using flex water connections to HPWH instead of hard pipe so the unit can be easily reoriented in the closet if ducting is required)
Inspector	<ul style="list-style-type: none"> • Perform on site verification to ensure as-built condition is in alignment with submitted plans and code requirements. • Would verify ventilation requirements are being met (currently most HPWH manufacturers require this verification) 	No significant impact.	No significant impact.	To ease compliance, would allow the individual building departments determine at what stage in construction adherence to ventilation requirements is verified

Table 394: Roles of Market Actors in Individual DHW Electric Ready

Market Actor	Task(s) in current compliance process relating to the CASE measure	How will the proposed measure impact the current task(s) or workflow?	How will the proposed code change impact compliance and enforcement?	Opportunities to minimize negative impacts of compliance requirement
Plumbing engineer	<ul style="list-style-type: none"> • Would design the plumbing systems including the gas individual water heater, which would trigger the proposed requirements • Would specify gas equipment, determine and coordinate space requirements, equipment weight, and drainage piping locations to the entire design team • Identify relevant mandatory requirements • Coordinate existing individual electric ready requirements to other design team members • Would coordinate with energy consultant and add content to the NRCC/LMCC compliance documentation based on project details for permit application • Perform construction administration activities to ensure design intent is met 	<ul style="list-style-type: none"> • Would need to negotiate space requirements with architect and owner • Would need to coordinate ventilation requirements with mechanical engineer and/or architect • Would coordinate code requirements for physical space, ventilation, and electrical sizing 	<ul style="list-style-type: none"> • Would need to fill out appropriate sections of the LMCC or NRCC form • The compliance and enforcement activities are important for this measure since the electric ready infrastructure won't affect the performance of the hot water system until the gas water heater is replaced with a HPWH 	Reference appendices can be updated to outline the requirements in detail
Electrical engineer	<ul style="list-style-type: none"> • Would plan for a 10 AWG branch circuit to the future HPWH according to current code • Receive criteria from the plumbing engineer • Document electrical system sizing on the plans 	<ul style="list-style-type: none"> • Not currently required to size all upstream systems for future load • Would size wire to meet a 30-amp load • Would explicitly require to account for the electrical loads in all building systems upstream of the dwelling unit electric panel • Would need to document compliance with new requirements 	The compliance and enforcement activities are important for this measure since the electric ready infrastructure won't affect the performance of the hot water system until the gas water heater is replaced with a HPWH	No significant impact
Mechanical Engineer	Would specify combustion air requirements	No significant impact	No significant impact	No significant impact

Market Actor	Task(s) in current compliance process relating to the CASE measure	How will the proposed measure impact the current task(s) or workflow?	How will the proposed code change impact compliance and enforcement?	Opportunities to minimize negative impacts of compliance requirement
Plans Examiner	<ul style="list-style-type: none"> • Would perform plan reviews of the gas water heater systems • Confirm that the plan set and compliance documents are supporting each other and that compliance is achieved 	<ul style="list-style-type: none"> • Would need to be aware of new mandatory electric ready requirements • Would perform plan reviews of the gas water heater systems and verify construction drawings meet current individual HPWH electric ready requirements • Would require verifying the design team has met code requirements for space, ventilation, and adequate sizing of electrical systems upstream of the dwelling unit electric panel 	The LMCC/NRCC compliance documents would assist the understanding of proposed requirements	Update training to include new electric ready requirements
General contractor	<ul style="list-style-type: none"> • Would hire specialized contractors as required • Would complete LMCI/NRCI compliance documents 	Would install an appropriately sized closet, ensuring the specified ventilation requirements are met, and coordinate with the construction team as needed to ensure the building is constructed adequately to meet new requirements	The compliance and enforcement activities are important for this measure since the electric ready infrastructure won't affect the performance of the hot water system until the gas water heater is replaced with a HPWH	Update training to include new electric ready requirements
Mechanical contractor	Would ensure combustion air requirements are met as specified by the mechanical engineer	Depending how the design team plans to meet proposed electric ready ventilation requirements, would install ductwork to serve future individual HPWH	No significant impact	Update training to include new electric ready requirements
Electrical Contractor	Would construct the building electrical systems as specified	The proposal would result in larger/higher capacity electrical systems	No significant impact	Update training to include new electric ready requirements
Plumbing Contractor	<ul style="list-style-type: none"> • Would install the individual DHW system as designed and per manufacturer instruction • Would install gas water heating system and any supporting systems such as the required condensate drainage piping, and specified • Would populate compliance forms and schedule on site verifications 	Closely adhere to design details during installation	No significant impact	Update training to include new electric ready requirements

Market Actor	Task(s) in current compliance process relating to the CASE measure	How will the proposed measure impact the current task(s) or workflow?	How will the proposed code change impact compliance and enforcement?	Opportunities to minimize negative impacts of compliance requirement
Inspector	Would review the LMCI/NRCI compliance documents and verifies the individual gas water heater meets all applicable building codes, including the existing electric ready requirements	Would verify the electric ready provisions meet the new code requirements, including closet space, ventilation, and building electrical system sizing	No significant impact	Compliance forms could be used to reduce the burden on the building official/inspector, while ensuring the proposal is properly enforced

Table 395: Roles of Market Actors in Central HPWH Electric Ready

Market Actor	Task(s) in current compliance process relating to the CASE measure	How will the proposed measure impact the current task(s) or workflow?	How will the proposed code change impact compliance and enforcement?	Opportunities to minimize negative impacts of compliance requirement
Plumbing Engineer	<ul style="list-style-type: none"> • Would design the plumbing systems including the central gas water heater, which triggers the proposed requirements • Would specify gas equipment, and determining and coordinating space requirements, electrical requirements, equipment weight, and drainage piping locations to the rest of the design team • Would coordinate with energy consultant and add content to the LMCC/NRCC documents based on project details • Would coordinate with energy consultant to model the HPWH system via compliance software 	<ul style="list-style-type: none"> • Would coordinate with electrical engineer for electrical panel sizing per code requirement. • Would coordinate the new requirements for the future central HPWH including electrical, physical space, structural, and ventilation requirements 	Design drawings would show additional design features and details to meet code requirements	Reference appendices can be updated to outline the requirements in detail
Electrical Engineer	Would design the electrical systems in the building, including the central gas water heater	Would plan for future central HPWH electrical requirements when sizing all the buildings electrical systems	No significant impact	No significant impact
Mechanical Engineer	Would design the HVAC systems in the building, including combustion air, outdoor air, and exhaust systems serving the central gas water heater (as applicable)	Depending on the project, could be engaged to size ductwork and/or louvers to ensure adequate ventilation for the future central HPWH	No significant impact	No significant impact

Market Actor	Task(s) in current compliance process relating to the CASE measure	How will the proposed measure impact the current task(s) or workflow?	How will the proposed code change impact compliance and enforcement?	Opportunities to minimize negative impacts of compliance requirement
Energy Consultant	<ul style="list-style-type: none"> • Would coordinate with plumbing engineer and add content to the LMCC/NRCC documents based on project details • Would coordinate with design engineers to model the central HPWH system via compliance software • Would prepare Title LMCC/NRCC documentation 	Closely coordinate with plumbing designer during design phase	No significant impact	No significant impact
Plans Examiner	Would perform plan check reviews of gas water heater systems and verify construction drawings meet code	Would require verifying the design team has met code requirements for space, ventilation, structural capacity, condensate drainage, and adequate sizing of electrical systems upstream of the dwelling unit electric panel	No significant impact	The LMCC/NRCC documents could assist in understanding which projects need to meet proposal requirements
Plumbing Contractor	<ul style="list-style-type: none"> • Would install the central HPWH system including heat pump, storage tanks, plumbing components, and specialties including mixed valves and control sensors – as designed and per manufacturer instruction • Would populate compliance forms and schedule on site verifications 	Closely adhere to design details during installation	No significant impact	Update training to include new electric ready requirements
General Contractor	<ul style="list-style-type: none"> • Would hire specialized subcontractors as required • Would coordinate with the construction team as needed to ensure the building is constructed adequately to meet new requirements • Would complete the LMCI.NRCI documents based on project details 	No significant impact	The compliance and enforcement activities are important for this measure since the electric ready infrastructure won't affect the performance of the hot water system until the gas water heater is replaced with a HPWH	Update training to include new electric ready requirements

Market Actor	Task(s) in current compliance process relating to the CASE measure	How will the proposed measure impact the current task(s) or workflow?	How will the proposed code change impact compliance and enforcement?	Opportunities to minimize negative impacts of compliance requirement
Mechanical Subcontractor	Would ensure combustion air requirements are met as specified	Depending how the design team plans to meet the proposed electric ventilation requirements, would have to install ductwork to serve future central HPWH	No significant impact	Update training to include new electric ready requirements
Electrical Subcontractor	Would build the electrical systems as specified	The proposal would result in larger/higher capacity electrical systems	No significant impact	Update training to include new electric ready requirements
Plumbing Subcontractor	Would install gas water heating system and any supporting systems such as the required condensate drainage piping, as specified	No significant impact	No significant impact	Update training to include new electric ready requirements
Commissioning Agent	<ul style="list-style-type: none"> • Either a design engineering team member or a contracted third party would perform the necessary commissioning testing to ensure system and controls are installed and function as designed 	No significant impact	No significant impact	No significant impact
Inspector	<ul style="list-style-type: none"> • Would review the LMCI/NRCI documents and verified the central gas heater meets all applicable building codes, including the existing electric ready requirements • Would verify the electric ready provisions meet new code requirements including closet space, ventilation, structural, and building electrical system sizing 	No significant impact	No significant impact	Compliance forms could be used to reduce the burden on the building official/inspector, while ensuring the proposal is properly enforced
ATT/HERS Rater	<ul style="list-style-type: none"> • Perform on site verification to ensure equipment, system design, piping configurations, and controls are in alignment with submitted plans and code requirements • Submit required compliance forms 	No significant impact	No significant impact	No significant impact

Appendix F: Summary of Stakeholder Engagement

Collaborating with stakeholders that might be impacted by proposed changes is a critical aspect of the Statewide CASE Team's efforts. The Statewide CASE Team aims to work with interested parties to identify and address issues associated with the proposed code changes so that the proposals presented to the CEC in this CASE Report are generally supported. Public stakeholders provide valuable feedback on draft analyses and help identify and address challenges to adoption including cost-effectiveness, market barriers, technical barriers, compliance and enforcement challenges, or potential impacts on human health or the environment. Some stakeholders also provide data that the Statewide CASE Team uses to support analyses.

This appendix summarizes the stakeholder engagement that the Statewide CASE Team conducted when developing and refining the recommendations presented in this report.

Utility-Sponsored Stakeholder Meetings

Utility-sponsored stakeholder meetings provide an opportunity to learn about the Statewide CASE Team's role in the advocacy effort and to hear about specific code change proposals that the Statewide CASE Team is pursuing for the 2025 code cycle. The goal of stakeholder meetings is to solicit input on proposals from stakeholders early enough to ensure the proposals and the supporting analyses are vetted and have as few outstanding issues as possible. To provide transparency in what the Statewide CASE Team is considering for code change proposals, during these meetings the Statewide CASE Team asks for feedback on:

- Proposed code changes
- Draft code language
- Draft assumptions and results for analyses
- Data to support assumptions
- Compliance and enforcement, and
- Technical and market feasibility

The Statewide CASE Team hosted two stakeholder meetings for DWH Distribution via webinar described in Table 396. Please see below for dates and links to event pages on [Title24Stakeholders.com](https://www.title24stakeholders.com). Materials from each meeting. Such as slide presentations, proposal summaries with code language, and meeting notes, are included in the bibliography section of this report.

Table 396: Utility-Sponsored Stakeholder Meetings

Meeting Name	Meeting Date	Event Page from Title24stakeholders.com
First Round of Multifamily DHW HPWH Utility-Sponsored Stakeholder Meeting	Friday, February 17, 2023	https://title24stakeholders.com/event/multifamily-domestic-hot-water-utility-sponsored-stakeholder-meeting/
Second Round of Multifamily DHW HPWH Utility-Sponsored Stakeholder Meeting	TBD	https://title24stakeholders.com/event/multifamily-hvac-and-envelope-utility-sponsored-stakeholder-meeting/

The first round of utility-sponsored stakeholder meetings occurred from February 2023 and were important for providing transparency and an early forum for stakeholders to offer feedback on measures being pursued by the Statewide CASE Team. The objectives of the first round of stakeholder meetings were to solicit input on the scope of the 2025 code cycle proposals; request data and feedback on the specific approaches, assumptions, and methodologies for the energy impacts and cost-effectiveness analyses; and understand potential technical and market barriers. The Statewide CASE Team also presented initial draft code language for stakeholders to review.

The second round of utility-sponsored stakeholder meetings occurred from TBD and provided updated details on proposed code changes. The second round of meetings introduced early results of energy, cost-effectiveness, and incremental cost analyses, and solicited feedback on refined draft code language.

Utility-sponsored stakeholder meetings were open to the public. For each stakeholder meeting, two promotional emails were distributed from info@title24stakeholders.com. One email was sent to the entire Title 24 Stakeholders listserv, totaling over 3,000 individuals, and a second email was sent to a targeted list of individuals on the listserv depending on their subscription preferences. The Title 24 Stakeholders' website listserv is an opt-in service and includes individuals from a wide variety of industries and trades, including manufacturers, advocacy groups, local government, and building and energy professionals. Each meeting was posted on the Title 24 Stakeholders' LinkedIn page (and cross-promoted on the CEC LinkedIn page) two weeks before each meeting to reach out to individuals and larger organizations and channels outside of the listserv. The Statewide CASE Team conducted extensive personal outreach to stakeholders identified in initial work plans who had not yet opted into the listserv. Exported webinar meeting data captured attendance numbers and individual comments, and recorded outcomes of live attendee polls to evaluate stakeholder participation and support.

Statewide CASE Team Communications

The Statewide CASE Team held personal communications over email and phone with numerous stakeholders when developing this report, listed in Table 397.

Table 397: Engaged Stakeholders

Organization/Individual Name	Market Role/Stakeholder Category	Housing Market Served
Brown Construction / Steve Mahieu	Contractor / Builder	Market Rate
D2 Industrial / Steve Angelo	Contractor / Builder	Market Rate
Villara Building Systems / Robert Campbell	Contractor / Builder	Market Rate
Engineering 350 / Kim Zylker	Designer	Affordable
Harris & Sloan / Kweku Ngissah	Designer	Market Rate
Harris & Sloan / Shawn Mayer	Designer	Market Rate
Hohbach-Lewin / Kevin Morton	Designer	Market Rate
PAE / John Lansing	Designer	Market Rate
Redwood Energy / Sean Armstrong	Designer	Affordable
Smith Group / Stet Sanborn	Designer	Market Rate
Hydronic Specialties Company / John Grose	Distributor	N/A
Spec Sales / Chris Sweeney	Distributor	N/A
AEA / Andy Brooks	Efficiency Advocate	Affordable
AEA / Jack Aitchison	Efficiency Advocate	Affordable
AEA / John Neal	Efficiency Advocate	Affordable
AEA / Nick Dirr	Efficiency Advocate	Affordable
AEA / Nick Young	Efficiency Advocate	Affordable
Energy 350 / Meg Waltner	Energy and Environmental Consultants	N/A
Larson Energy Research / Ben Larson	Energy and Environmental Consultants	N/A
New Buildings Institute / Amruta Khanolkar	Energy and Environmental Consultants	Not Applicable
The Northwest Energy Efficiency Alliance (NEEA) / Geoff Wickes	Industry Associations	N/A
The Northwest Energy Efficiency Alliance (NEEA) / Kevin Rose	Industry Associations	N/A
The Northwest Energy Efficiency Alliance (NEEA) / Blake Ringeisen	Industry Associations	N/A
The Northwest Energy Efficiency Alliance (NEEA) / Mark Rehley	Industry Associations	N/A
AO Smith / Stephen Memory	Manufacturer	N/A

Organization/Individual Name	Market Role/Stakeholder Category	Housing Market Served
AO Smith / Tim Rooney	Manufacturer	N/A
AO Smith / Joshua Greene	Manufacturer	N/A
Bradford White Water Heaters / Michael Corbett	Manufacturer	N/A
Lochinvar / Dan Rettig	Manufacturer	N/A
Lochinvar / Rob Wiseman	Manufacturer	N/A
Lochinvar / Jeff Kleiss	Manufacturer	N/A
Lochinvar / Mehdi Doura	Manufacturer	N/A
Lochinvar / Jennifer Russel	Manufacturer	N/A
Thermaxx / Rose Titcomb	Manufacturer	N/A
Thermaxx / Sam Esterman	Manufacturer	N/A
RenewABILITY Energy Inc. / Rob Buchalter	Manufacturer	N/A

Many stakeholders have actively contributed to this CASE Report and are part of the Statewide CASE Team.

Table 398: Statewide CASE Team Internal Subject Matter Experts

Organization	Role
AEA	Design Consultant
ECOTOPE	Engineer/Designer
Villara	Plumbing Contractor
WAM	Engineer/Designer and Contractor
P2S	Engineer/Designer

CPC Appendix M Pipe Sizing

The Statewide CASE Team conducted interviews with 5 designers, 2 design consultants and 4 contractors to garner the information about market adoption of Appendix M for pipe sizing calculation and their opinion on this methodology. Associated challenges related to the adoption of the methodology is also discussed in these interviews and summarized in Section 3.2.

Pipe Insulation Enhancement

The Statewide CASE Team interviewed different market actors including several designers, two general contractors, one manufacturer of pipe insulation materials, and one pipe insulation sub-contractor to understand their extrapolation of code requirements for different component in the distribution system and their typical practice

in the building system. This information is used to improve the code and an explanation is provided in Section 4.2.

Automatic Balancing Valves and Demand Control Clean-up

The Statewide CASE Team interviewed 11 market actors to dissect the type of balancing valve usage in current practice and why those are preferred compared to other available options and to identify the methodology used to design them. The lessons learned are summarized in Section 5.2.

MMVs

The Statewide CASE Team conducted interviews with 5 designers, 2 design consultants and 4 contractors to understand 1) the type of MMVs that are implemented in the current market scenario and the reason behind that selection, 2) challenges related to designing, installation, and usage of MMV and 3) in overall, the factors that impact the performance of the MMV in the building. The summarization of the interviews is listed in Section 6.2.

Central HPWH

The Statewide CASE Team conducted interviews with 3 multifamily designers, 2 design consultants, program implementer, general contractor, and plumbing contractor to garner feedback on 1) common central HPWH solutions for multifamily new-construction buildings, 2) drivers and decision-making process for central HPWH projects, 3) design challenges and lessons learned. Lessons learned are summarized in Section 7.2.

The stakeholder outreach involving design team professionals resulted in promising signs for the state of central HPWH multifamily design and construction in California. Industry professionals shared project information to support all-electric market assessment. Project data sources included Association for Energy Affordability, Advanced Build Energy Program, CMFNH, EPIC, SMUD, Dodge database.

Individual HPWH Ventilation

The Statewide CASE Team conducted interviews with designers, consultants, manufacturers, and contractors to collect feedback on the proposed code changes and associated costs. This included direct discussions with the three major manufacturers of individual HPWHs, as well as energy consultants who recently conducted field studies of individual HPWHs in multifamily buildings. Members of the Statewide CASE Team also attended industry conferences, including the ASHRAE Annual Conference, AHR Expo, Dry Climate Forum, and ACEEE Hot Water Forum, to present on multifamily individual HPWH studies, promote engagement with the CASE progress, and solicit comments and conversations with stakeholders.

As with the Central HPWH measure, industry professionals shared project information to support all-electric market assessment. Project data sources included Association for Energy Affordability, Advanced Build Energy Program, CMFNH, EPIC, SMUD, Dodge database. More information can be found in Section 8.2.

Individual and Central Electric Ready

The Statewide CASE Team interviewed different market actors like designer, design consultant, program implementer, contractor to review proposed code requirements, cost associated with retrofitting to all-electric systems. Findings are presented in Sections 9.2 and 10.2.

Engagement with DIPs

The Statewide CASE Team conducted interviews with organizations that serve DIPs. See Table 397.

Appendix G: Energy Cost Savings in Nominal Dollars

The CEC requested energy cost savings over the 30-year period of analysis in both 2026 PV\$ and nominal dollars. The cost-effectiveness analysis uses energy cost values in 2026 PV\$. Costs and cost-effectiveness using and 2026 PV\$ are presented in Section x.4 within Sections 3 through 10 of this report. This appendix presents energy cost savings in nominal dollars.

HPWH Appendix M

Table 399: Nominal 30-year LSC Savings – Per Dwelling Unit – New Construction – HPWH - AppM – LowRiseGarden

Climate Zone	30-Year LSC Electricity Savings (Nominal \$)	30-Year LSC Natural Gas Savings (Nominal \$)	Total 30-Year LSC Savings (Nominal \$)
1	\$1,031	\$0	\$1,031
2	\$939	\$0	\$939
3	\$942	\$0	\$942
4	\$924	\$0	\$924
5	\$989	\$0	\$989
6	\$917	\$0	\$917
7	\$888	\$0	\$888
8	\$890	\$0	\$890
9	\$894	\$0	\$894
10	\$902	\$0	\$902
11	\$917	\$0	\$917
12	\$915	\$0	\$915
13	\$908	\$0	\$908
14	\$916	\$0	\$916
15	\$848	\$0	\$848
16	\$955	\$0	\$955

Table 400: Nominal 30-year LSC Savings – Per Dwelling Unit – New Construction – HPWH - AppM – LoadedCorridor

Climate Zone	30-Year LSC Electricity Savings (Nominal \$)	30-Year LSC Natural Gas Savings (Nominal \$)	Total 30-Year LSC Savings (Nominal \$)
1	\$1,759	\$0	\$1,759
2	\$1,664	\$0	\$1,664
3	\$1,670	\$0	\$1,670
4	\$1,644	\$0	\$1,644
5	\$1,716	\$0	\$1,716
6	\$1,641	\$0	\$1,641
7	\$1,598	\$0	\$1,598
8	\$1,610	\$0	\$1,610
9	\$1,615	\$0	\$1,615
10	\$1,624	\$0	\$1,624
11	\$1,638	\$0	\$1,638
12	\$1,638	\$0	\$1,638
13	\$1,629	\$0	\$1,629
14	\$1,638	\$0	\$1,638
15	\$1,558	\$0	\$1,558
16	\$1,683	\$0	\$1,683

Table 401: Nominal 30-year LSC Savings – Per Dwelling Unit – New Construction – HPWH - AppM – MidRiseMixedUse

Climate Zone	30-Year LSC Electricity Savings (Nominal \$)	30-Year LSC Natural Gas Savings (Nominal \$)	Total 30-Year LSC Savings (Nominal \$)
1	\$2,089	\$0	\$2,089
2	\$1,923	\$0	\$1,923
3	\$1,938	\$0	\$1,938
4	\$1,895	\$0	\$1,895
5	\$2,013	\$0	\$2,013
6	\$1,884	\$0	\$1,884
7	\$1,829	\$0	\$1,829
8	\$1,834	\$0	\$1,834
9	\$1,845	\$0	\$1,845
10	\$1,857	\$0	\$1,857
11	\$1,883	\$0	\$1,883
12	\$1,885	\$0	\$1,885
13	\$1,866	\$0	\$1,866
14	\$1,881	\$0	\$1,881
15	\$1,752	\$0	\$1,752
16	\$1,952	\$0	\$1,952

Table 402: Nominal LSC Cost Savings Over 30-Year Period of Analysis – Per Dwelling Unit – New Construction – HPWH - AppM – HighRiseMixedUse

Climate Zone	30-Year LSC Electricity Savings (Nominal \$)	30-Year LSC Natural Gas Savings (Nominal \$)	Total 30-Year LSC Savings (Nominal \$)
1	\$1,341	\$0	\$1,341
2	\$1,244	\$0	\$1,244
3	\$1,252	\$0	\$1,252
4	\$1,227	\$0	\$1,227
5	\$1,297	\$0	\$1,297
6	\$1,221	\$0	\$1,221
7	\$1,188	\$0	\$1,188
8	\$1,192	\$0	\$1,192
9	\$1,198	\$0	\$1,198
10	\$1,205	\$0	\$1,205
11	\$1,220	\$0	\$1,220
12	\$1,221	\$0	\$1,221
13	\$1,210	\$0	\$1,210
14	\$1,219	\$0	\$1,219
15	\$1,143	\$0	\$1,143
16	\$1,262	\$0	\$1,262

Table 403: Nominal 30-year LSC Savings – Per Dwelling Unit – New Construction – Gas - AppM – LowRiseGarden

Climate Zone	30-Year LSC Electricity Savings (Nominal \$)	30-Year LSC Natural Gas Savings (Nominal \$)	Total 30-Year LSC Savings (Nominal \$)
1	\$0	\$914	\$914
2	\$0	\$833	\$833
3	\$0	\$835	\$835
4	\$0	\$824	\$824
5	\$0	\$879	\$879
6	\$0	\$814	\$814
7	\$0	\$798	\$798
8	\$0	\$793	\$793
9	\$0	\$793	\$793
10	\$0	\$804	\$804
11	\$0	\$818	\$818
12	\$0	\$815	\$815
13	\$0	\$811	\$811
14	\$0	\$816	\$816
15	\$0	\$749	\$749
16	\$0	\$844	\$844

Table 404: Nominal 30-year LSC Savings – Per Dwelling Unit – New Construction – Gas - AppM – LoadedCorridor

Climate Zone	30-Year LSC Electricity Savings (Nominal \$)	30-Year LSC Natural Gas Savings (Nominal \$)	Total 30-Year LSC Savings (Nominal \$)
1	\$0	\$2,631	\$2,631
2	\$0	\$2,539	\$2,539
3	\$0	\$2,548	\$2,548
4	\$0	\$2,529	\$2,529
5	\$0	\$2,591	\$2,591
6	\$0	\$2,519	\$2,519
7	\$0	\$2,502	\$2,502
8	\$0	\$2,493	\$2,493
9	\$0	\$2,499	\$2,499
10	\$0	\$2,507	\$2,507
11	\$0	\$2,523	\$2,523
12	\$0	\$2,523	\$2,523
13	\$0	\$2,515	\$2,515
14	\$0	\$2,523	\$2,523
15	\$0	\$2,446	\$2,446
16	\$0	\$2,553	\$2,553

Table 405: Nominal 30-year LSC Savings – Per Dwelling Unit – New Construction – Gas - AppM – MidRiseMixedUse

Climate Zone	30-Year LSC Electricity Savings (Nominal \$)	30-Year LSC Natural Gas Savings (Nominal \$)	Total 30-Year LSC Savings (Nominal \$)
1	\$0	\$2,396	\$2,396
2	\$0	\$2,248	\$2,248
3	\$0	\$2,262	\$2,262
4	\$0	\$2,231	\$2,231
5	\$0	\$2,332	\$2,332
6	\$0	\$2,214	\$2,214
7	\$0	\$2,187	\$2,187
8	\$0	\$2,176	\$2,176
9	\$0	\$2,185	\$2,185
10	\$0	\$2,196	\$2,196
11	\$0	\$2,222	\$2,222
12	\$0	\$2,222	\$2,222
13	\$0	\$2,208	\$2,208
14	\$0	\$2,219	\$2,219
15	\$0	\$2,106	\$2,106
16	\$0	\$2,268	\$2,268

Table 406: Nominal 30-year LSC Savings – Per Dwelling Unit – New Construction – Gas - AppM – HighRiseMixedUse

Climate Zone	30-Year LSC Electricity Savings (Nominal \$)	30-Year LSC Natural Gas Savings (Nominal \$)	Total 30-Year LSC Savings (Nominal \$)
1	\$0	\$2,060	\$2,060
2	\$0	\$1,972	\$1,972
3	\$0	\$1,981	\$1,981
4	\$0	\$1,963	\$1,963
5	\$0	\$2,022	\$2,022
6	\$0	\$1,953	\$1,953
7	\$0	\$1,938	\$1,938
8	\$0	\$1,930	\$1,930
9	\$0	\$1,936	\$1,936
10	\$0	\$1,942	\$1,942
11	\$0	\$1,957	\$1,957
12	\$0	\$1,957	\$1,957
13	\$0	\$1,949	\$1,949
14	\$0	\$1,956	\$1,956
15	\$0	\$1,889	\$1,889
16	\$0	\$1,985	\$1,985

Pipe Insulation Enhancement

Table 407: Nominal 30-year LSC Savings – Per Dwelling Unit – New Construction – HPWH - Insulation – LowRiseGarden

Climate Zone	30-Year LSC Electricity Savings (Nominal \$)	30-Year LSC Natural Gas Savings (Nominal \$)	Total 30-Year LSC Savings (Nominal \$)
1	\$3,908	\$0	\$3,908
2	\$3,701	\$0	\$3,701
3	\$3,719	\$0	\$3,719
4	\$3,664	\$0	\$3,664
5	\$3,813	\$0	\$3,813
6	\$3,657	\$0	\$3,657
7	\$3,575	\$0	\$3,575
8	\$3,592	\$0	\$3,592
9	\$3,615	\$0	\$3,615
10	\$3,620	\$0	\$3,620
11	\$3,649	\$0	\$3,649
12	\$3,657	\$0	\$3,657
13	\$3,627	\$0	\$3,627
14	\$3,650	\$0	\$3,650
15	\$3,504	\$0	\$3,504
16	\$3,745	\$0	\$3,745

Table 408: Nominal 30-year LSC Savings – Per Dwelling Unit – New Construction – HPWH - Insulation – LoadedCorridor

Climate Zone	30-Year LSC Electricity Savings (Nominal \$)	30-Year LSC Natural Gas Savings (Nominal \$)	Total 30-Year LSC Savings (Nominal \$)
1	\$2,789	\$0	\$2,789
2	\$2,624	\$0	\$2,624
3	\$2,636	\$0	\$2,636
4	\$2,590	\$0	\$2,590
5	\$2,714	\$0	\$2,714
6	\$2,583	\$0	\$2,583
7	\$2,513	\$0	\$2,513
8	\$2,530	\$0	\$2,530
9	\$2,540	\$0	\$2,540
10	\$2,555	\$0	\$2,555
11	\$2,580	\$0	\$2,580
12	\$2,580	\$0	\$2,580
13	\$2,565	\$0	\$2,565
14	\$2,580	\$0	\$2,580
15	\$2,442	\$0	\$2,442
16	\$2,656	\$0	\$2,656

Table 409: Nominal 30-year LSC Savings – Per Dwelling Unit – New Construction – HPWH - Insulation – MidRiseMixedUse

Climate Zone	30-Year LSC Electricity Savings (Nominal \$)	30-Year LSC Natural Gas Savings (Nominal \$)	Total 30-Year LSC Savings (Nominal \$)
1	\$2,943	\$0	\$2,943
2	\$2,729	\$0	\$2,729
3	\$2,747	\$0	\$2,747
4	\$2,692	\$0	\$2,692
5	\$2,845	\$0	\$2,845
6	\$2,678	\$0	\$2,678
7	\$2,606	\$0	\$2,606
8	\$2,614	\$0	\$2,614
9	\$2,628	\$0	\$2,628
10	\$2,643	\$0	\$2,643
11	\$2,676	\$0	\$2,676
12	\$2,678	\$0	\$2,678
13	\$2,655	\$0	\$2,655
14	\$2,675	\$0	\$2,675
15	\$2,508	\$0	\$2,508
16	\$2,768	\$0	\$2,768

Table 410: Nominal 30-year LSC Savings – Per Dwelling Unit – New Construction – HPWH - Insulation – HighRiseMixedUse

Climate Zone	30-Year LSC Electricity Savings (Nominal \$)	30-Year LSC Natural Gas Savings (Nominal \$)	Total 30-Year LSC Savings (Nominal \$)
1	\$2,710	\$0	\$2,710
2	\$2,532	\$0	\$2,532
3	\$2,548	\$0	\$2,548
4	\$2,501	\$0	\$2,501
5	\$2,628	\$0	\$2,628
6	\$2,492	\$0	\$2,492
7	\$2,429	\$0	\$2,429
8	\$2,438	\$0	\$2,438
9	\$2,449	\$0	\$2,449
10	\$2,462	\$0	\$2,462
11	\$2,488	\$0	\$2,488
12	\$2,490	\$0	\$2,490
13	\$2,470	\$0	\$2,470
14	\$2,488	\$0	\$2,488
15	\$2,349	\$0	\$2,349
16	\$2,566	\$0	\$2,566

Table 411: Nominal 30-year LSC Savings – Per Dwelling Unit – New Construction – Gas - Insulation – LowRiseGarden

Climate Zone	30-Year LSC Electricity Savings (Nominal \$)	30-Year LSC Natural Gas Savings (Nominal \$)	Total 30-Year LSC Savings (Nominal \$)
1	\$0	\$7,644	\$7,644
2	\$0	\$7,458	\$7,458
3	\$0	\$7,476	\$7,476
4	\$0	\$7,438	\$7,438
5	\$0	\$7,564	\$7,564
6	\$0	\$7,422	\$7,422
7	\$0	\$7,396	\$7,396
8	\$0	\$7,373	\$7,373
9	\$0	\$7,386	\$7,386
10	\$0	\$7,399	\$7,399
11	\$0	\$7,426	\$7,426
12	\$0	\$7,429	\$7,429
13	\$0	\$7,409	\$7,409
14	\$0	\$7,427	\$7,427
15	\$0	\$7,284	\$7,284
16	\$0	\$7,489	\$7,489

Table 412: Nominal 30-year LSC Savings – Per Dwelling Unit – New Construction – Gas - Insulation – LoadedCorridor

Climate Zone	30-Year LSC Electricity Savings (Nominal \$)	30-Year LSC Natural Gas Savings (Nominal \$)	Total 30-Year LSC Savings (Nominal \$)
1	\$0	\$4,596	\$4,596
2	\$0	\$4,437	\$4,437
3	\$0	\$4,453	\$4,453
4	\$0	\$4,420	\$4,420
5	\$0	\$4,527	\$4,527
6	\$0	\$4,403	\$4,403
7	\$0	\$4,374	\$4,374
8	\$0	\$4,358	\$4,358
9	\$0	\$4,368	\$4,368
10	\$0	\$4,382	\$4,382
11	\$0	\$4,409	\$4,409
12	\$0	\$4,410	\$4,410
13	\$0	\$4,395	\$4,395
14	\$0	\$4,409	\$4,409
15	\$0	\$4,277	\$4,277
16	\$0	\$4,461	\$4,461

Table 413: Nominal 30-year LSC Savings – Per Dwelling Unit – New Construction – Gas - Insulation – MidRiseMixedUse

Climate Zone	30-Year LSC Electricity Savings (Nominal \$)	30-Year LSC Natural Gas Savings (Nominal \$)	Total 30-Year LSC Savings (Nominal \$)
1	\$0	\$4,537	\$4,537
2	\$0	\$4,345	\$4,345
3	\$0	\$4,364	\$4,364
4	\$0	\$4,324	\$4,324
5	\$0	\$4,454	\$4,454
6	\$0	\$4,303	\$4,303
7	\$0	\$4,271	\$4,271
8	\$0	\$4,254	\$4,254
9	\$0	\$5,061	\$5,061
10	\$0	\$4,280	\$4,280
11	\$0	\$4,312	\$4,312
12	\$0	\$5,107	\$5,107
13	\$0	\$4,294	\$4,294
14	\$0	\$4,310	\$4,310
15	\$0	\$4,959	\$4,959
16	\$0	\$4,373	\$4,373

Table 414: Nominal 30-year LSC Savings – Per Dwelling Unit – New Construction – Gas - Insulation – HighRiseMixedUse

Climate Zone	30-Year LSC Electricity Savings (Nominal \$)	30-Year LSC Natural Gas Savings (Nominal \$)	Total 30-Year LSC Savings (Nominal \$)
1	\$0	\$5,155	\$5,155
2	\$0	\$4,997	\$4,997
3	\$0	\$5,012	\$5,012
4	\$0	\$4,979	\$4,979
5	\$0	\$5,087	\$5,087
6	\$0	\$4,963	\$4,963
7	\$0	\$4,939	\$4,939
8	\$0	\$4,922	\$4,922
9	\$0	\$4,932	\$4,932
10	\$0	\$4,944	\$4,944
11	\$0	\$4,969	\$4,969
12	\$0	\$4,969	\$4,969
13	\$0	\$4,954	\$4,954
14	\$0	\$4,968	\$4,968
15	\$0	\$4,848	\$4,848
16	\$0	\$5,021	\$5,021

Require Balancing Valves

Table 415: Nominal 30-year LSC Savings – Per Dwelling Unit – New Construction & Additions – HPWH-Balance-Valve-Temp-120 – LowRiseGarden

Climate Zone	30-Year LSC Electricity Savings (Nominal \$)	30-Year LSC Natural Gas Savings (Nominal \$)	Total 30-Year LSC Savings (Nominal \$)
1	\$732	\$0	\$732
2	\$667	\$0	\$667
3	\$664	\$0	\$664
4	\$656	\$0	\$656
5	\$702	\$0	\$702
6	\$651	\$0	\$651
7	\$631	\$0	\$631
8	\$632	\$0	\$632
9	\$513	\$0	\$513
10	\$641	\$0	\$641
11	\$651	\$0	\$651
12	\$682	\$0	\$682
13	\$645	\$0	\$645
14	\$651	\$0	\$651
15	\$661	\$0	\$661
16	\$678	\$0	\$678

Table 416: Nominal 30-year LSC Savings – Per Dwelling Unit – New Construction & Additions – HPWH-Balance-Valve-Temp-120 – LoadedCorridor

Climate Zone	30-Year LSC Electricity Savings (Nominal \$)	30-Year LSC Natural Gas Savings (Nominal \$)	Total 30-Year LSC Savings (Nominal \$)
1	\$189	\$0	\$189
2	\$174	\$0	\$174
3	\$173	\$0	\$173
4	\$171	\$0	\$171
5	\$182	\$0	\$182
6	\$170	\$0	\$170
7	\$164	\$0	\$164
8	\$165	\$0	\$165
9	\$179	\$0	\$179
10	\$167	\$0	\$167
11	\$170	\$0	\$170
12	\$176	\$0	\$176
13	\$168	\$0	\$168
14	\$170	\$0	\$170
15	\$185	\$0	\$185
16	\$176	\$0	\$176

Table 417: Nominal 30-year LSC Savings – Per Dwelling Unit – New Construction & Additions – Gas - Balance-Valve-Temp-120 – LowRiseGarden

Climate Zone	30-Year LSC Electricity Savings (Nominal \$)	30-Year LSC Natural Gas Savings (Nominal \$)	Total 30-Year LSC Savings (Nominal \$)
1	\$0	\$650	\$650
2	\$0	\$592	\$592
3	\$0	\$593	\$593
4	\$0	\$585	\$585
5	\$0	\$624	\$624
6	\$0	\$578	\$578
7	\$0	\$567	\$567
8	\$0	\$563	\$563
9	\$0	\$455	\$455
10	\$0	\$571	\$571
11	\$0	\$581	\$581
12	\$0	\$605	\$605
13	\$0	\$576	\$576
14	\$0	\$580	\$580
15	\$0	\$595	\$595
16	\$0	\$599	\$599

Table 418: Nominal 30-year LSC Savings – Per Dwelling Unit – New Construction & Additions – Gas - Balance-Valve-Temp-120 – LoadedCorridor

Climate Zone	30-Year LSC Electricity Savings (Nominal \$)	30-Year LSC Natural Gas Savings (Nominal \$)	Total 30-Year LSC Savings (Nominal \$)
1	\$0	\$168	\$168
2	\$0	\$154	\$154
3	\$0	\$154	\$154
4	\$0	\$152	\$152
5	\$0	\$162	\$162
6	\$0	\$150	\$150
7	\$0	\$147	\$147
8	\$0	\$146	\$146
9	\$0	\$159	\$159
10	\$0	\$148	\$148
11	\$0	\$151	\$151
12	\$0	\$156	\$156
13	\$0	\$150	\$150
14	\$0	\$151	\$151
15	\$0	\$164	\$164
16	\$0	\$156	\$156

Table 419: Nominal 30-year LSC Savings – Per Dwelling Unit – Alterations – HPWH - Balance-Valve-Temp-120 – LowRiseGarden

Climate Zone	30-Year LSC Electricity Savings (Nominal \$)	30-Year LSC Natural Gas Savings (Nominal \$)	Total 30-Year LSC Savings (Nominal \$)
1	\$732	\$0	\$732
2	\$667	\$0	\$667
3	\$664	\$0	\$664
4	\$656	\$0	\$656
5	\$702	\$0	\$702
6	\$651	\$0	\$651
7	\$631	\$0	\$631
8	\$632	\$0	\$632
9	\$513	\$0	\$513
10	\$641	\$0	\$641
11	\$651	\$0	\$651
12	\$682	\$0	\$682
13	\$645	\$0	\$645
14	\$651	\$0	\$651
15	\$661	\$0	\$661
16	\$678	\$0	\$678

Table 420: Nominal 30-year LSC Savings – Per Dwelling Unit – Alterations – HPWH - Balance-Valve-Temp-120 – LoadedCorridor

Climate Zone	30-Year LSC Electricity Savings (Nominal \$)	30-Year LSC Natural Gas Savings (Nominal \$)	Total 30-Year LSC Savings (Nominal \$)
1	\$189	\$0	\$189
2	\$174	\$0	\$174
3	\$173	\$0	\$173
4	\$171	\$0	\$171
5	\$182	\$0	\$182
6	\$170	\$0	\$170
7	\$164	\$0	\$164
8	\$165	\$0	\$165
9	\$179	\$0	\$179
10	\$167	\$0	\$167
11	\$170	\$0	\$170
12	\$176	\$0	\$176
13	\$168	\$0	\$168
14	\$170	\$0	\$170
15	\$185	\$0	\$185
16	\$176	\$0	\$176

Table 421: Nominal 30-year LSC Savings – Per Dwelling Unit – Alterations – Gas - Balance-Valve-Temp-120 – LowRiseGarden

Climate Zone	30-Year LSC Electricity Savings (Nominal \$)	30-Year LSC Natural Gas Savings (Nominal \$)	Total 30-Year LSC Savings (Nominal \$)
1	\$0	\$650	\$650
2	\$0	\$592	\$592
3	\$0	\$593	\$593
4	\$0	\$585	\$585
5	\$0	\$624	\$624
6	\$0	\$578	\$578
7	\$0	\$567	\$567
8	\$0	\$563	\$563
9	\$0	\$455	\$455
10	\$0	\$571	\$571
11	\$0	\$581	\$581
12	\$0	\$605	\$605
13	\$0	\$576	\$576
14	\$0	\$580	\$580
15	\$0	\$595	\$595
16	\$0	\$599	\$599

Table 422: Nominal 30-year LSC Savings – Per Dwelling Unit – Alterations – Gas - Balance-Valve-Temp-120 – LoadedCorridor

Climate Zone	30-Year LSC Electricity Savings (Nominal \$)	30-Year LSC Natural Gas Savings (Nominal \$)	Total 30-Year LSC Savings (Nominal \$)
1	\$0	\$168	\$168
2	\$0	\$154	\$154
3	\$0	\$154	\$154
4	\$0	\$152	\$152
5	\$0	\$162	\$162
6	\$0	\$150	\$150
7	\$0	\$147	\$147
8	\$0	\$146	\$146
9	\$0	\$159	\$159
10	\$0	\$148	\$148
11	\$0	\$151	\$151
12	\$0	\$156	\$156
13	\$0	\$150	\$150
14	\$0	\$151	\$151
15	\$0	\$164	\$164
16	\$0	\$156	\$156

Requiring Master Mixing Valves

Table 423: Nominal 30-year LSC Savings – Per Dwelling Unit – New Construction – Mandatory HPWH - Master Mixing Valve – LowRiseGarden

Climate Zone	30-Year LSC Electricity Savings (Nominal \$)	30-Year LSC Natural Gas Savings (Nominal \$)	Total 30-Year LSC Savings (Nominal \$)
1	\$5,617	\$0	\$5,617
2	\$5,053	\$0	\$5,053
3	\$4,990	\$0	\$4,990
4	\$5,191	\$0	\$5,191
5	\$4,756	\$0	\$4,756
6	\$3,667	\$0	\$3,667
7	\$4,396	\$0	\$4,396
8	\$3,956	\$0	\$3,956
9	\$3,899	\$0	\$3,899
10	\$3,983	\$0	\$3,983
11	\$4,870	\$0	\$4,870
12	\$4,751	\$0	\$4,751
13	\$4,563	\$0	\$4,563
14	\$4,421	\$0	\$4,421
15	\$3,562	\$0	\$3,562
16	\$4,363	\$0	\$4,363

Table 424: Nominal 30-year LSC Savings – Per Dwelling Unit – New Construction – Mandatory HPWH - Master Mixing Valve – LoadedCorridor

Climate Zone	30-Year LSC Electricity Savings (Nominal \$)	30-Year LSC Natural Gas Savings (Nominal \$)	Total 30-Year LSC Savings (Nominal \$)
1	\$5,473	\$0	\$5,473
2	\$5,032	\$0	\$5,032
3	\$4,863	\$0	\$4,863
4	\$5,239	\$0	\$5,239
5	\$4,657	\$0	\$4,657
6	\$3,705	\$0	\$3,705
7	\$4,427	\$0	\$4,427
8	\$4,109	\$0	\$4,109
9	\$3,993	\$0	\$3,993
10	\$4,139	\$0	\$4,139
11	\$5,078	\$0	\$5,078
12	\$4,943	\$0	\$4,943
13	\$4,779	\$0	\$4,779
14	\$4,671	\$0	\$4,671
15	\$3,952	\$0	\$3,952
16	\$4,497	\$0	\$4,497

Table 425: Nominal 30-year LSC Savings – Per Dwelling Unit – New Construction – Mandatory HPWH - Master Mixing Valve – MidRiseMixedUse

Climate Zone	30-Year LSC Electricity Savings (Nominal \$)	30-Year LSC Natural Gas Savings (Nominal \$)	Total 30-Year LSC Savings (Nominal \$)
1	\$9,174	\$0	\$9,174
2	\$8,179	\$0	\$8,179
3	\$8,311	\$0	\$8,311
4	\$8,433	\$0	\$8,433
5	\$8,038	\$0	\$8,038
6	\$6,720	\$0	\$6,720
7	\$7,556	\$0	\$7,556
8	\$7,792	\$0	\$7,792
9	\$7,623	\$0	\$7,623
10	\$7,971	\$0	\$7,971
11	\$9,258	\$0	\$9,258
12	\$8,555	\$0	\$8,555
13	\$9,176	\$0	\$9,176
14	\$8,177	\$0	\$8,177
15	\$8,344	\$0	\$8,344
16	\$9,224	\$0	\$9,224

Table 426: Nominal 30-year LSC Savings – Per Dwelling Unit – New Construction & Additions – Mandatory HPWH - Master Mixing Valve – HighRiseMixedUse

Climate Zone	30-Year LSC Electricity Savings (Nominal \$)	30-Year LSC Natural Gas Savings (Nominal \$)	Total 30-Year LSC Savings (Nominal \$)
1	\$7,211	\$0	\$7,211
2	\$6,963	\$0	\$6,963
3	\$6,599	\$0	\$6,599
4	\$7,248	\$0	\$7,248
5	\$6,392	\$0	\$6,392
6	\$5,762	\$0	\$5,762
7	\$6,220	\$0	\$6,220
8	\$6,504	\$0	\$6,504
9	\$6,509	\$0	\$6,509
10	\$6,806	\$0	\$6,806
11	\$7,909	\$0	\$7,909
12	\$7,176	\$0	\$7,176
13	\$7,818	\$0	\$7,818
14	\$7,253	\$0	\$7,253
15	\$8,273	\$0	\$8,273
16	\$7,266	\$0	\$7,266

Table 427: Nominal 30-year LSC Savings – Per Dwelling Unit – New Construction – Mandatory Gas - Master Mixing Valve – LowRiseGarden

Climate Zone	30-Year LSC Electricity Savings (Nominal \$)	30-Year LSC Natural Gas Savings (Nominal \$)	Total 30-Year LSC Savings (Nominal \$)
1	\$0	\$3,358	\$3,358
2	\$0	\$2,890	\$2,890
3	\$0	\$2,833	\$2,833
4	\$0	\$2,628	\$2,628
5	\$0	\$2,795	\$2,795
6	\$0	\$2,452	\$2,452
7	\$0	\$2,474	\$2,474
8	\$0	\$2,333	\$2,333
9	\$0	\$2,331	\$2,331
10	\$0	\$2,284	\$2,284
11	\$0	\$2,466	\$2,466
12	\$0	\$2,644	\$2,644
13	\$0	\$2,387	\$2,387
14	\$0	\$2,347	\$2,347
15	\$0	\$1,682	\$1,682
16	\$0	\$4,837	\$4,837

Table 428: Nominal 30-year LSC Savings – Per Dwelling Unit – New Construction – Mandatory Gas - Master Mixing Valve – LoadedCorridor

Climate Zone	30-Year LSC Electricity Savings (Nominal \$)	30-Year LSC Natural Gas Savings (Nominal \$)	Total 30-Year LSC Savings (Nominal \$)
1	\$0	\$3,886	\$3,886
2	\$0	\$4,475	\$4,475
3	\$0	\$4,418	\$4,418
4	\$0	\$4,217	\$4,217
5	\$0	\$4,388	\$4,388
6	\$0	\$4,202	\$4,202
7	\$0	\$4,052	\$4,052
8	\$0	\$4,076	\$4,076
9	\$0	\$4,084	\$4,084
10	\$0	\$3,534	\$3,534
11	\$0	\$3,600	\$3,600
12	\$0	\$3,780	\$3,780
13	\$0	\$3,659	\$3,659
14	\$0	\$3,581	\$3,581
15	\$0	\$3,237	\$3,237
16	\$0	\$5,903	\$5,903

Table 429: Nominal 30-year LSC Savings – Per Dwelling Unit – New Construction – Mandatory Gas - Master Mixing Valve – MidRiseMixedUse

Climate Zone	30-Year LSC Electricity Savings (Nominal \$)	30-Year LSC Natural Gas Savings (Nominal \$)	Total 30-Year LSC Savings (Nominal \$)
1	\$0	\$4,904	\$4,904
2	\$0	\$4,474	\$4,474
3	\$0	\$4,356	\$4,356
4	\$0	\$4,274	\$4,274
5	\$0	\$4,355	\$4,355
6	\$0	\$3,856	\$3,856
7	\$0	\$3,802	\$3,802
8	\$0	\$3,727	\$3,727
9	\$0	\$3,784	\$3,784
10	\$0	\$3,740	\$3,740
11	\$0	\$4,003	\$4,003
12	\$0	\$4,187	\$4,187
13	\$0	\$3,866	\$3,866
14	\$0	\$4,040	\$4,040
15	\$0	\$3,057	\$3,057
16	\$0	\$5,359	\$5,359

Table 430: Nominal 30-year LSC Savings – Per Dwelling Unit – New Construction – Mandatory Gas - Master Mixing Valve – HighRiseMixedUse

Climate Zone	30-Year LSC Electricity Savings (Nominal \$)	30-Year LSC Natural Gas Savings (Nominal \$)	Total 30-Year LSC Savings (Nominal \$)
1	\$0	\$3,700	\$3,700
2	\$0	\$3,291	\$3,291
3	\$0	\$3,234	\$3,234
4	\$0	\$3,140	\$3,140
5	\$0	\$3,243	\$3,243
6	\$0	\$2,916	\$2,916
7	\$0	\$2,879	\$2,879
8	\$0	\$2,804	\$2,804
9	\$0	\$2,835	\$2,835
10	\$0	\$2,791	\$2,791
11	\$0	\$2,923	\$2,923
12	\$0	\$3,082	\$3,082
13	\$0	\$2,842	\$2,842
14	\$0	\$2,952	\$2,952
15	\$0	\$2,271	\$2,271
16	\$0	\$4,397	\$4,397

Table 431: Nominal LSC Cost Savings Over 30-Year Period of Analysis – Per Dwelling Unit – New Construction – Compliance HPWH - Master Mixing Valve – LowRiseGarden

Climate Zone	30-Year LSC Electricity Savings (Nominal \$)	30-Year LSC Natural Gas Savings (Nominal \$)	Total 30-Year LSC Savings (Nominal \$)
1	\$5	\$0	\$5
2	\$5	\$0	\$5
3	\$5	\$0	\$5
4	\$5	\$0	\$5
5	\$4	\$0	\$4
6	\$3	\$0	\$3
7	\$4	\$0	\$4
8	\$4	\$0	\$4
9	\$4	\$0	\$4
10	\$4	\$0	\$4
11	\$5	\$0	\$5
12	\$4	\$0	\$4
13	\$4	\$0	\$4
14	\$4	\$0	\$4
15	\$3	\$0	\$3
16	\$4	\$0	\$4

Table 432: Nominal 30-year LSC Savings – Per Dwelling Unit – New Construction – Compliance HPWH - Master Mixing Valve – LoadedCorridor

Climate Zone	30-Year LSC Electricity Savings (Nominal \$)	30-Year LSC Natural Gas Savings (Nominal \$)	Total 30-Year LSC Savings (Nominal \$)
1	\$20	\$0	\$20
2	\$18	\$0	\$18
3	\$18	\$0	\$18
4	\$19	\$0	\$19
5	\$17	\$0	\$17
6	\$13	\$0	\$13
7	\$16	\$0	\$16
8	\$15	\$0	\$15
9	\$15	\$0	\$15
10	\$15	\$0	\$15
11	\$18	\$0	\$18
12	\$18	\$0	\$18
13	\$17	\$0	\$17
14	\$17	\$0	\$17
15	\$14	\$0	\$14
16	\$16	\$0	\$16

Table 433: Nominal 30-year LSC Savings – Per Dwelling Unit – New Construction – Compliance HPWH - Master Mixing Valve – MidRiseMixedUse

Climate Zone	30-Year LSC Electricity Savings (Nominal \$)	30-Year LSC Natural Gas Savings (Nominal \$)	Total 30-Year LSC Savings (Nominal \$)
1	\$71	\$0	\$71
2	\$63	\$0	\$63
3	\$64	\$0	\$64
4	\$65	\$0	\$65
5	\$62	\$0	\$62
6	\$52	\$0	\$52
7	\$58	\$0	\$58
8	\$60	\$0	\$60
9	\$59	\$0	\$59
10	\$61	\$0	\$61
11	\$71	\$0	\$71
12	\$66	\$0	\$66
13	\$71	\$0	\$71
14	\$63	\$0	\$63
15	\$64	\$0	\$64
16	\$71	\$0	\$71

Table 434: Nominal 30-year LSC Savings – Per Dwelling Unit – New Construction – Compliance HPWH - Master Mixing Valve – HighRiseMixedUse

Climate Zone	30-Year LSC Electricity Savings (Nominal \$)	30-Year LSC Natural Gas Savings (Nominal \$)	Total 30-Year LSC Savings (Nominal \$)
1	\$88	\$0	\$88
2	\$85	\$0	\$85
3	\$81	\$0	\$81
4	\$89	\$0	\$89
5	\$78	\$0	\$78
6	\$71	\$0	\$71
7	\$76	\$0	\$76
8	\$80	\$0	\$80
9	\$80	\$0	\$80
10	\$83	\$0	\$83
11	\$97	\$0	\$97
12	\$88	\$0	\$88
13	\$96	\$0	\$96
14	\$89	\$0	\$89
15	\$101	\$0	\$101
16	\$89	\$0	\$89

Table 435: Nominal 30-year LSC Savings – Per Dwelling Unit – New Construction – Compliance Gas - Master Mixing Valve – LowRiseGarden

Climate Zone	30-Year LSC Electricity Savings (Nominal \$)	30-Year LSC Natural Gas Savings (Nominal \$)	Total 30-Year LSC Savings (Nominal \$)
1	\$0	\$3	\$3
2	\$0	\$3	\$3
3	\$0	\$3	\$3
4	\$0	\$2	\$2
5	\$0	\$3	\$3
6	\$0	\$2	\$2
7	\$0	\$2	\$2
8	\$0	\$2	\$2
9	\$0	\$2	\$2
10	\$0	\$2	\$2
11	\$0	\$2	\$2
12	\$0	\$2	\$2
13	\$0	\$2	\$2
14	\$0	\$2	\$2
15	\$0	\$2	\$2
16	\$0	\$5	\$5

Table 436: Nominal 30-year LSC Savings – Per Dwelling Unit – New Construction – Compliance Gas - Master Mixing Valve – LoadedCorridor

Climate Zone	30-Year LSC Electricity Savings (Nominal \$)	30-Year LSC Natural Gas Savings (Nominal \$)	Total 30-Year LSC Savings (Nominal \$)
1	\$0	\$14	\$14
2	\$0	\$16	\$16
3	\$0	\$16	\$16
4	\$0	\$15	\$15
5	\$0	\$16	\$16
6	\$0	\$15	\$15
7	\$0	\$15	\$15
8	\$0	\$15	\$15
9	\$0	\$15	\$15
10	\$0	\$13	\$13
11	\$0	\$13	\$13
12	\$0	\$14	\$14
13	\$0	\$13	\$13
14	\$0	\$13	\$13
15	\$0	\$12	\$12
16	\$0	\$21	\$21

Table 437: Nominal 30-year LSC Savings – Per Dwelling Unit – New Construction – Compliance Gas - Master Mixing Valve – MidRiseMixedUse

Climate Zone	30-Year LSC Electricity Savings (Nominal \$)	30-Year LSC Natural Gas Savings (Nominal \$)	Total 30-Year LSC Savings (Nominal \$)
1	\$0	\$38	\$38
2	\$0	\$34	\$34
3	\$0	\$34	\$34
4	\$0	\$33	\$33
5	\$0	\$34	\$34
6	\$0	\$30	\$30
7	\$0	\$29	\$29
8	\$0	\$29	\$29
9	\$0	\$29	\$29
10	\$0	\$29	\$29
11	\$0	\$31	\$31
12	\$0	\$32	\$32
13	\$0	\$30	\$30
14	\$0	\$31	\$31
15	\$0	\$24	\$24
16	\$0	\$41	\$41

Table 438: Nominal 30-year LSC Savings – Per Dwelling Unit – New Construction – Compliance Gas - Master Mixing Valve – HighRiseMixedUse

Climate Zone	30-Year LSC Electricity Savings (Nominal \$)	30-Year LSC Natural Gas Savings (Nominal \$)	Total 30-Year LSC Savings (Nominal \$)
1	\$0	\$45	\$45
2	\$0	\$40	\$40
3	\$0	\$40	\$40
4	\$0	\$39	\$39
5	\$0	\$40	\$40
6	\$0	\$36	\$36
7	\$0	\$35	\$35
8	\$0	\$34	\$34
9	\$0	\$35	\$35
10	\$0	\$34	\$34
11	\$0	\$36	\$36
12	\$0	\$38	\$38
13	\$0	\$35	\$35
14	\$0	\$36	\$36
15	\$0	\$28	\$28
16	\$0	\$54	\$54

Central HPWH

Table 439: Nominal 30-year LSC Savings – Per Dwelling Unit – New Construction – HPWH - SPST – LowRiseGarden

Climate Zone	30-Year LSC Electricity Savings (Nominal \$)	30-Year LSC Natural Gas Savings (Nominal \$)	Total 30-Year LSC Savings (Nominal \$)
1	\$6,351	\$0	\$6,351
2	\$6,017	\$0	\$6,017
3	\$5,883	\$0	\$5,883
4	\$5,365	\$0	\$5,365
5	\$5,940	\$0	\$5,940
6	\$5,176	\$0	\$5,176
7	\$5,355	\$0	\$5,355
8	\$4,842	\$0	\$4,842
9	\$4,821	\$0	\$4,821
10	\$4,680	\$0	\$4,680
11	\$4,747	\$0	\$4,747
12	\$5,296	\$0	\$5,296
13	\$4,536	\$0	\$4,536
14	\$4,687	\$0	\$4,687
15	\$3,313	\$0	\$3,313
16	\$6,247	(\$118)	\$6,130

Table 440: Nominal 30-year LSC Savings – Per Dwelling Unit – New Construction – HPWH - SPST – LoadedCorridor

Climate Zone	30-Year LSC Electricity Savings (Nominal \$)	30-Year LSC Natural Gas Savings (Nominal \$)	Total 30-Year LSC Savings (Nominal \$)
1	\$6,497	\$0	\$6,497
2	\$5,891	\$0	\$5,891
3	\$5,650	\$0	\$5,650
4	\$4,984	\$0	\$4,984
5	\$5,563	\$0	\$5,563
6	\$4,589	\$0	\$4,589
7	\$4,621	\$0	\$4,621
8	\$4,148	\$0	\$4,148
9	\$4,208	\$0	\$4,208
10	\$4,065	\$0	\$4,065
11	\$4,258	\$0	\$4,258
12	\$4,734	\$0	\$4,734
13	\$4,062	\$0	\$4,062
14	\$4,436	\$0	\$4,436
15	\$2,644	\$0	\$2,644
16	\$6,130	(\$17)	\$6,113

Table 441: Nominal 30-year LSC Savings – Per Dwelling Unit – New Construction – HPWH - SPST – MidRiseMixedUse

Climate Zone	30-Year LSC Electricity Savings (Nominal \$)	30-Year LSC Natural Gas Savings (Nominal \$)	Total 30-Year LSC Savings (Nominal \$)
1	\$7,425	(\$6)	\$7,418
2	\$6,816	\$0	\$6,816
3	\$6,609	\$0	\$6,609
4	\$5,836	\$0	\$5,836
5	\$6,611	\$0	\$6,611
6	\$5,612	\$0	\$5,612
7	\$5,652	\$0	\$5,652
8	\$5,052	\$0	\$5,052
9	\$5,128	\$0	\$5,128
10	\$4,927	\$0	\$4,927
11	\$4,985	\$0	\$4,985
12	\$5,677	\$0	\$5,677
13	\$4,715	\$0	\$4,715
14	\$5,291	\$0	\$5,291
15	\$3,135	\$0	\$3,135
16	\$10,631	(\$25)	\$10,606

Table 442: Nominal 30-year LSC Savings – Per Dwelling Unit – New Construction – HPWH - SPST – HighRiseMixedUse

Climate Zone	30-Year LSC Electricity Savings (Nominal \$)	30-Year LSC Natural Gas Savings (Nominal \$)	Total 30-Year LSC Savings (Nominal \$)
1	\$6,366	(\$7)	\$6,360
2	\$5,580	\$0	\$5,580
3	\$5,342	\$0	\$5,342
4	\$4,664	\$0	\$4,664
5	\$5,326	\$0	\$5,326
6	\$4,375	\$0	\$4,375
7	\$4,484	\$0	\$4,484
8	\$3,943	\$0	\$3,943
9	\$4,012	\$0	\$4,012
10	\$3,835	\$0	\$3,835
11	\$4,079	\$0	\$4,079
12	\$4,561	\$0	\$4,561
13	\$3,733	\$0	\$3,733
14	\$4,444	\$0	\$4,444
15	\$2,373	\$0	\$2,373
16	\$9,188	(\$13)	\$9,174

Table 443: Nominal 30-year LSC Savings – Per Dwelling Unit – New Construction – HPWH-SPRetP – LowRiseGarden

Climate Zone	30-Year LSC Electricity Savings (Nominal \$)	30-Year LSC Natural Gas Savings (Nominal \$)	Total 30-Year LSC Savings (Nominal \$)
1	\$1,110	\$0	\$1,110
2	\$1,241	\$0	\$1,241
3	\$1,363	\$0	\$1,363
4	\$1,240	\$0	\$1,240
5	\$1,284	\$0	\$1,284
6	\$1,508	\$0	\$1,508
7	\$1,553	\$0	\$1,553
8	\$1,549	\$0	\$1,549
9	\$1,505	\$0	\$1,505
10	\$1,519	\$0	\$1,519
11	\$1,383	\$0	\$1,383
12	\$1,341	\$0	\$1,341
13	\$1,439	\$0	\$1,439
14	\$1,395	\$0	\$1,395
15	\$1,900	\$0	\$1,900
16	\$1,307	(\$242)	\$1,066

Table 444: Nominal 30-year LSC Savings – Per Dwelling Unit – New Construction – HPWH-SPRetP – LoadedCorridor

Climate Zone	30-Year LSC Electricity Savings (Nominal \$)	30-Year LSC Natural Gas Savings (Nominal \$)	Total 30-Year LSC Savings (Nominal \$)
1	\$186	\$0	\$186
2	\$261	\$0	\$261
3	\$286	\$0	\$286
4	\$274	\$0	\$274
5	\$251	\$0	\$251
6	\$360	\$0	\$360
7	\$329	\$0	\$329
8	\$391	\$0	\$391
9	\$392	\$0	\$392
10	\$399	\$0	\$399
11	\$326	\$0	\$326
12	\$277	\$0	\$277
13	\$375	\$0	\$375
14	\$342	\$0	\$342
15	\$551	\$0	\$551
16	\$190	\$8	\$198

Table 445: Nominal 30-year LSC Savings – Per Dwelling Unit – New Construction – HPWH - SPRetP – MidRiseMixedUse

Climate Zone	30-Year LSC Electricity Savings (Nominal \$)	30-Year LSC Natural Gas Savings (Nominal \$)	Total 30-Year LSC Savings (Nominal \$)
1	\$146	(\$0)	\$146
2	\$232	\$0	\$232
3	\$278	\$0	\$278
4	\$214	\$0	\$214
5	\$206	\$0	\$206
6	\$308	\$0	\$308
7	\$240	\$0	\$240
8	\$324	\$0	\$324
9	\$333	\$0	\$333
10	\$336	\$0	\$336
11	\$235	\$0	\$235
12	\$263	\$0	\$263
13	\$283	\$0	\$283
14	\$176	\$0	\$176
15	\$446	\$0	\$446
16	\$34	\$0	\$35

Table 446: Nominal 30-year LSC Savings – Per Dwelling Unit – New Construction – HPWH - SPRetP – HighRiseMixedUse

Climate Zone	30-Year LSC Electricity Savings (Nominal \$)	30-Year LSC Natural Gas Savings (Nominal \$)	Total 30-Year LSC Savings (Nominal \$)
1	(\$37)	\$1	(\$36)
2	(\$6)	\$0	(\$6)
3	\$2	\$0	\$2
4	(\$27)	\$0	(\$27)
5	\$58	\$0	\$58
6	\$47	\$0	\$47
7	(\$47)	\$0	(\$47)
8	\$58	\$0	\$58
9	\$76	\$0	\$76
10	\$73	\$0	\$73
11	(\$19)	\$0	(\$19)
12	\$32	\$0	\$32
13	\$41	\$0	\$41
14	(\$58)	\$0	(\$58)
15	\$127	\$0	\$127
16	(\$198)	(\$0)	(\$198)

Table 447: Nominal 30-year LSC Savings – Per Dwelling Unit – New Construction – HPWH - MPRetP – LowRiseGarden

Climate Zone	30-Year LSC Electricity Savings (Nominal \$)	30-Year LSC Natural Gas Savings (Nominal \$)	Total 30-Year LSC Savings (Nominal \$)
1	(\$4,574)	\$0	(\$4,574)
2	(\$3,871)	\$0	(\$3,871)
3	(\$3,644)	\$0	(\$3,644)
4	(\$3,425)	\$0	(\$3,425)
5	(\$3,599)	\$0	(\$3,599)
6	(\$2,613)	\$0	(\$2,613)
7	(\$2,500)	\$0	(\$2,500)
8	(\$2,354)	\$0	(\$2,354)
9	(\$2,488)	\$0	(\$2,488)
10	(\$2,376)	\$0	(\$2,376)
11	(\$2,830)	\$0	(\$2,830)
12	(\$3,177)	\$0	(\$3,177)
13	(\$2,603)	\$0	(\$2,603)
14	(\$2,917)	\$0	(\$2,917)
15	(\$1,575)	\$0	(\$1,575)
16	(\$4,424)	(\$206)	(\$4,630)

Table 448: Nominal 30-year LSC Savings – Per Dwelling Unit – New Construction – HPWH - MPRetP – LoadedCorridor

Climate Zone	30-Year LSC Electricity Savings (Nominal \$)	30-Year LSC Natural Gas Savings (Nominal \$)	Total 30-Year LSC Savings (Nominal \$)
1	(\$5,066)	\$0	(\$5,066)
2	(\$4,422)	\$0	(\$4,422)
3	(\$4,190)	\$0	(\$4,190)
4	(\$3,955)	\$0	(\$3,955)
5	(\$4,214)	\$0	(\$4,214)
6	(\$3,280)	\$0	(\$3,280)
7	(\$3,277)	\$0	(\$3,277)
8	(\$3,052)	\$0	(\$3,052)
9	(\$3,153)	\$0	(\$3,153)
10	(\$3,055)	\$0	(\$3,055)
11	(\$3,477)	\$0	(\$3,477)
12	(\$3,825)	\$0	(\$3,825)
13	(\$3,264)	\$0	(\$3,264)
14	(\$3,541)	\$0	(\$3,541)
15	(\$2,415)	\$0	(\$2,415)
16	(\$4,997)	(\$3)	(\$4,999)

Table 449: Nominal 30-year LSC Savings – Per Dwelling Unit – New Construction – HPWH - MPRetP – MidRiseMixedUse

Climate Zone	30-Year LSC Electricity Savings (Nominal \$)	30-Year LSC Natural Gas Savings (Nominal \$)	Total 30-Year LSC Savings (Nominal \$)
1	(\$3,325)	\$3	(\$3,323)
2	(\$3,011)	\$0	(\$3,011)
3	(\$2,844)	\$0	(\$2,844)
4	(\$2,656)	\$0	(\$2,656)
5	(\$2,963)	\$0	(\$2,963)
6	(\$2,333)	\$0	(\$2,333)
7	(\$2,353)	\$0	(\$2,353)
8	(\$2,119)	\$0	(\$2,119)
9	(\$2,145)	\$0	(\$2,145)
10	(\$2,084)	\$0	(\$2,084)
11	(\$2,273)	\$0	(\$2,273)
12	(\$2,557)	\$0	(\$2,557)
13	(\$2,167)	\$0	(\$2,167)
14	(\$2,274)	\$0	(\$2,274)
15	(\$1,343)	\$0	(\$1,343)
16	(\$2,589)	\$4	(\$2,585)

Table 450: Nominal 30-year LSC Savings – Per Dwelling Unit – New Construction – HPWH - MPRetP – HighRiseMixedUse

Climate Zone	30-Year LSC Electricity Savings (Nominal \$)	30-Year LSC Natural Gas Savings (Nominal \$)	Total 30-Year LSC Savings (Nominal \$)
1	(\$2,661)	\$3	(\$2,658)
2	(\$2,400)	\$0	(\$2,400)
3	(\$2,327)	\$0	(\$2,327)
4	(\$2,209)	\$0	(\$2,209)
5	(\$2,380)	\$0	(\$2,380)
6	(\$1,991)	\$0	(\$1,991)
7	(\$2,002)	\$0	(\$2,002)
8	(\$1,803)	\$0	(\$1,803)
9	(\$1,821)	\$0	(\$1,821)
10	(\$1,798)	\$0	(\$1,798)
11	(\$1,912)	\$0	(\$1,912)
12	(\$2,077)	\$0	(\$2,077)
13	(\$1,837)	\$0	(\$1,837)
14	(\$1,896)	\$0	(\$1,896)
15	(\$1,229)	\$0	(\$1,229)
16	(\$1,965)	\$4	(\$1,961)

Table 451: Nominal 30-year LSC Savings – Per Dwelling Unit – New Construction – HPWH - SPwMPST – MidRiseMixedUse

Climate Zone	30-Year LSC Electricity Savings (Nominal \$)	30-Year LSC Natural Gas Savings (Nominal \$)	Total 30-Year LSC Savings (Nominal \$)
1	\$6,989	(\$7)	\$6,982
2	\$6,423	\$0	\$6,423
3	\$6,201	\$0	\$6,201
4	\$5,593	\$0	\$5,593
5	\$6,192	\$0	\$6,192
6	\$5,157	\$0	\$5,157
7	\$5,134	\$0	\$5,134
8	\$4,719	\$0	\$4,719
9	\$4,781	\$0	\$4,781
10	\$4,616	\$0	\$4,616
11	\$4,794	\$0	\$4,794
12	\$5,423	\$0	\$5,423
13	\$4,522	\$0	\$4,522
14	\$5,012	\$0	\$5,012
15	\$3,022	\$0	\$3,022
16	\$10,271	(\$25)	\$10,246

Table 452: Nominal 30-year LSC Savings – Per Dwelling Unit – New Construction – HPWH - SPwMPST – HighRiseMixedUse

Climate Zone	30-Year LSC Electricity Savings (Nominal \$)	30-Year LSC Natural Gas Savings (Nominal \$)	Total 30-Year LSC Savings (Nominal \$)
1	\$5,907	(\$7)	\$5,900
2	\$5,157	\$0	\$5,157
3	\$4,932	\$0	\$4,932
4	\$4,361	\$0	\$4,361
5	\$4,999	\$0	\$4,999
6	\$4,038	\$0	\$4,038
7	\$4,057	\$0	\$4,057
8	\$3,663	\$0	\$3,663
9	\$3,715	\$0	\$3,715
10	\$3,546	\$0	\$3,546
11	\$3,825	\$0	\$3,825
12	\$4,294	\$0	\$4,294
13	\$3,503	\$0	\$3,503
14	\$4,138	\$0	\$4,138
15	\$2,187	\$0	\$2,187
16	\$8,687	(\$12)	\$8,675

Individual HPWH Ventilation

Table 453: Nominal 30-year LSC Savings – Per Dwelling Unit – New Construction – Ventilation - Exterior Closet – LowRiseGarden

Climate Zone	30-Year LSC Electricity Savings (Nominal \$)	30-Year LSC Natural Gas Savings (Nominal \$)	Total 30-Year LSC Savings (Nominal \$)
1	\$15,032	\$0	\$15,032
2	\$12,452	\$0	\$12,452
3	\$13,942	\$0	\$13,942
4	\$11,705	\$0	\$11,705
5	\$13,469	\$0	\$13,469
6	\$11,297	\$0	\$11,297
7	\$11,377	\$0	\$11,377
8	\$10,327	\$0	\$10,327
9	\$10,301	\$0	\$10,301
10	\$9,816	\$0	\$9,816
11	\$9,326	\$0	\$9,326
12	\$10,792	\$0	\$10,792
13	\$9,137	\$0	\$9,137
14	\$9,038	\$0	\$9,038
15	\$6,817	\$0	\$6,817
16	\$9,329	\$0	\$9,329

Table 454: Nominal 30-year LSC Savings – Per Dwelling Unit – New Construction – Ventilation - Exterior Closet – LoadedCorridor

Climate Zone	30-Year LSC Electricity Savings (Nominal \$)	30-Year LSC Natural Gas Savings (Nominal \$)	Total 30-Year LSC Savings (Nominal \$)
1	\$15,254	\$0	\$15,254
2	\$12,650	\$0	\$12,650
3	\$14,260	\$0	\$14,260
4	\$11,972	\$0	\$11,972
5	\$13,767	\$0	\$13,767
6	\$11,600	\$0	\$11,600
7	\$11,625	\$0	\$11,625
8	\$10,577	\$0	\$10,577
9	\$10,597	\$0	\$10,597
10	\$10,096	\$0	\$10,096
11	\$9,523	\$0	\$9,523
12	\$10,964	\$0	\$10,964
13	\$9,296	\$0	\$9,296
14	\$9,273	\$0	\$9,273
15	\$7,052	\$0	\$7,052
16	\$9,495	\$0	\$9,495

Table 455: Nominal 30-year LSC Savings – Per Dwelling Unit – New Construction – Ventilation - Exterior Closet – SF500

Climate Zone	30-Year LSC Electricity Savings (Nominal \$)	30-Year LSC Natural Gas Savings (Nominal \$)	Total 30-Year LSC Savings (Nominal \$)
1	\$13,596	\$0	\$13,596
2	\$11,486	\$0	\$11,486
3	\$12,754	\$0	\$12,754
4	\$10,801	\$0	\$10,801
5	\$12,358	\$0	\$12,358
6	\$10,446	\$0	\$10,446
7	\$10,298	\$0	\$10,298
8	\$9,566	\$0	\$9,566
9	\$9,529	\$0	\$9,529
10	\$9,085	\$0	\$9,085
11	\$8,704	\$0	\$8,704
12	\$9,891	\$0	\$9,891
13	\$8,417	\$0	\$8,417
14	\$8,443	\$0	\$8,443
15	\$6,508	\$0	\$6,508
16	\$8,520	\$0	\$8,520

Table 456: Nominal 30-year LSC Savings – Per Dwelling Unit – New Construction – Ventilation - Exterior Closet – SF2100

Climate Zone	30-Year LSC Electricity Savings (Nominal \$)	30-Year LSC Natural Gas Savings (Nominal \$)	Total 30-Year LSC Savings (Nominal \$)
1	\$17,836	\$0	\$17,836
2	\$14,614	\$0	\$14,614
3	\$17,044	\$0	\$17,044
4	\$14,213	\$0	\$14,213
5	\$16,370	\$0	\$16,370
6	\$13,966	\$0	\$13,966
7	\$13,998	\$0	\$13,998
8	\$12,593	\$0	\$12,593
9	\$12,864	\$0	\$12,864
10	\$12,231	\$0	\$12,231
11	\$11,128	\$0	\$11,128
12	\$12,722	\$0	\$12,722
13	\$10,812	\$0	\$10,812
14	\$11,039	\$0	\$11,039
15	\$8,546	\$0	\$8,546
16	\$11,135	\$0	\$11,135

Table 457: Nominal 30-year LSC Savings – Per Dwelling Unit – New Construction – Ventilation - Exterior Closet – SF2700

Climate Zone	30-Year LSC Electricity Savings (Nominal \$)	30-Year LSC Natural Gas Savings (Nominal \$)	Total 30-Year LSC Savings (Nominal \$)
1	\$19,884	\$0	\$19,884
2	\$16,455	\$0	\$16,455
3	\$18,423	\$0	\$18,423
4	\$15,827	\$0	\$15,827
5	\$17,762	\$0	\$17,762
6	\$14,964	\$0	\$14,964
7	\$14,970	\$0	\$14,970
8	\$13,796	\$0	\$13,796
9	\$13,957	\$0	\$13,957
10	\$13,308	\$0	\$13,308
11	\$12,579	\$0	\$12,579
12	\$14,251	\$0	\$14,251
13	\$12,344	\$0	\$12,344
14	\$12,124	\$0	\$12,124
15	\$9,236	\$0	\$9,236
16	\$12,016	\$0	\$12,016

Table 458: Nominal 30-year LSC Savings – Per Dwelling Unit – Alterations – Ventilation - Exterior Closet – LowRiseGarden

Climate Zone	30-Year LSC Electricity Savings (Nominal \$)	30-Year LSC Natural Gas Savings (Nominal \$)	Total 30-Year LSC Savings (Nominal \$)
1	\$15,032	\$0	\$15,032
2	\$12,452	\$0	\$12,452
3	\$13,942	\$0	\$13,942
4	\$11,705	\$0	\$11,705
5	\$13,469	\$0	\$13,469
6	\$11,297	\$0	\$11,297
7	\$11,377	\$0	\$11,377
8	\$10,327	\$0	\$10,327
9	\$10,301	\$0	\$10,301
10	\$9,816	\$0	\$9,816
11	\$9,326	\$0	\$9,326
12	\$10,792	\$0	\$10,792
13	\$9,137	\$0	\$9,137
14	\$9,038	\$0	\$9,038
15	\$6,817	\$0	\$6,817
16	\$9,329	\$0	\$9,329

Table 459: Nominal 30-year LSC Savings – Per Dwelling Unit – Alterations – Ventilation - Exterior Closet – LoadedCorridor

Climate Zone	30-Year LSC Electricity Savings (Nominal \$)	30-Year LSC Natural Gas Savings (Nominal \$)	Total 30-Year LSC Savings (Nominal \$)
1	\$15,254	\$0	\$15,254
2	\$12,650	\$0	\$12,650
3	\$14,260	\$0	\$14,260
4	\$11,972	\$0	\$11,972
5	\$13,767	\$0	\$13,767
6	\$11,600	\$0	\$11,600
7	\$11,625	\$0	\$11,625
8	\$10,577	\$0	\$10,577
9	\$10,597	\$0	\$10,597
10	\$10,096	\$0	\$10,096
11	\$9,523	\$0	\$9,523
12	\$10,964	\$0	\$10,964
13	\$9,296	\$0	\$9,296
14	\$9,273	\$0	\$9,273
15	\$7,052	\$0	\$7,052
16	\$9,495	\$0	\$9,495

Table 460: Nominal 30-year LSC Savings – Per Dwelling Unit – Alterations – Ventilation - Exterior Closet – MidRiseMixedUse

Climate Zone	30-Year LSC Electricity Savings (Nominal \$)	30-Year LSC Natural Gas Savings (Nominal \$)	Total 30-Year LSC Savings (Nominal \$)
1	\$15,019	\$0	\$15,019
2	\$12,471	\$0	\$12,471
3	\$14,007	\$0	\$14,007
4	\$11,769	\$0	\$11,769
5	\$13,531	\$0	\$13,531
6	\$11,385	\$0	\$11,385
7	\$11,409	\$0	\$11,409
8	\$10,394	\$0	\$10,394
9	\$10,391	\$0	\$10,391
10	\$9,902	\$0	\$9,902
11	\$9,377	\$0	\$9,377
12	\$10,804	\$0	\$10,804
13	\$9,158	\$0	\$9,158
14	\$9,112	\$0	\$9,112
15	\$6,917	\$0	\$6,917
16	\$9,346	\$0	\$9,346

Table 461: Nominal 30-year LSC Savings – Per Dwelling Unit – Alterations – Ventilation - Exterior Closet – HighRiseMixedUse

Climate Zone	30-Year LSC Electricity Savings (Nominal \$)	30-Year LSC Natural Gas Savings (Nominal \$)	Total 30-Year LSC Savings (Nominal \$)
1	\$14,701	\$0	\$14,701
2	\$12,227	\$0	\$12,227
3	\$13,667	\$0	\$13,667
4	\$11,496	\$0	\$11,496
5	\$13,213	\$0	\$13,213
6	\$11,100	\$0	\$11,100
7	\$11,128	\$0	\$11,128
8	\$10,151	\$0	\$10,151
9	\$10,120	\$0	\$10,120
10	\$9,647	\$0	\$9,647
11	\$9,182	\$0	\$9,182
12	\$10,584	\$0	\$10,584
13	\$8,971	\$0	\$8,971
14	\$8,901	\$0	\$8,901
15	\$6,744	\$0	\$6,744
16	\$9,143	\$0	\$9,143

Table 462: Nominal 30-year LSC Savings – Per Dwelling Unit– Alterations – Ventilation - Exterior Closet – SF500

Climate Zone	30-Year LSC Electricity Savings (Nominal \$)	30-Year LSC Natural Gas Savings (Nominal \$)	Total 30-Year LSC Savings (Nominal \$)
1	\$13,596	\$0	\$13,596
2	\$11,486	\$0	\$11,486
3	\$12,754	\$0	\$12,754
4	\$10,801	\$0	\$10,801
5	\$12,358	\$0	\$12,358
6	\$10,446	\$0	\$10,446
7	\$10,298	\$0	\$10,298
8	\$9,566	\$0	\$9,566
9	\$9,529	\$0	\$9,529
10	\$9,085	\$0	\$9,085
11	\$8,704	\$0	\$8,704
12	\$9,891	\$0	\$9,891
13	\$8,417	\$0	\$8,417
14	\$8,443	\$0	\$8,443
15	\$6,508	\$0	\$6,508
16	\$8,520	\$0	\$8,520

Table 463: Nominal 30-year LSC Savings – Per Dwelling Unit – Alterations – Ventilation - Exterior Closet – SF2100

Climate Zone	30-Year LSC Electricity Savings (Nominal \$)	30-Year LSC Natural Gas Savings (Nominal \$)	Total 30-Year LSC Savings (Nominal \$)
1	\$17,836	\$0	\$17,836
2	\$14,614	\$0	\$14,614
3	\$17,044	\$0	\$17,044
4	\$14,213	\$0	\$14,213
5	\$16,370	\$0	\$16,370
6	\$13,966	\$0	\$13,966
7	\$13,998	\$0	\$13,998
8	\$12,593	\$0	\$12,593
9	\$12,864	\$0	\$12,864
10	\$12,231	\$0	\$12,231
11	\$11,128	\$0	\$11,128
12	\$12,722	\$0	\$12,722
13	\$10,812	\$0	\$10,812
14	\$11,039	\$0	\$11,039
15	\$8,546	\$0	\$8,546
16	\$11,135	\$0	\$11,135

Table 464: Nominal 30-year LSC Savings – Per Dwelling Unit – Alterations – Ventilation - Exterior Closet – SF2700

Climate Zone	30-Year LSC Electricity Savings (Nominal \$)	30-Year LSC Natural Gas Savings (Nominal \$)	Total 30-Year LSC Savings (Nominal \$)
1	\$19,884	\$0	\$19,884
2	\$16,455	\$0	\$16,455
3	\$18,423	\$0	\$18,423
4	\$15,827	\$0	\$15,827
5	\$17,762	\$0	\$17,762
6	\$14,964	\$0	\$14,964
7	\$14,970	\$0	\$14,970
8	\$13,796	\$0	\$13,796
9	\$13,957	\$0	\$13,957
10	\$13,308	\$0	\$13,308
11	\$12,579	\$0	\$12,579
12	\$14,251	\$0	\$14,251
13	\$12,344	\$0	\$12,344
14	\$12,124	\$0	\$12,124
15	\$9,236	\$0	\$9,236
16	\$12,016	\$0	\$12,016

Table 465: Nominal 30-year LSC Savings – Per Dwelling Unit – New Construction – Ventilation - Interior Closet – LowRiseGarden

Climate Zone	30-Year LSC Electricity Savings (Nominal \$)	30-Year LSC Natural Gas Savings (Nominal \$)	Total 30-Year LSC Savings (Nominal \$)
1	\$13,035	\$0	\$13,035
2	\$11,743	\$0	\$11,743
3	\$11,703	\$0	\$11,703
4	\$10,816	\$0	\$10,816
5	\$11,742	\$0	\$11,742
6	\$10,430	\$0	\$10,430
7	\$10,303	\$0	\$10,303
8	\$9,974	\$0	\$9,974
9	\$10,039	\$0	\$10,039
10	\$9,938	\$0	\$9,938
11	\$10,251	\$0	\$10,251
12	\$10,780	\$0	\$10,780
13	\$9,867	\$0	\$9,867
14	\$10,228	\$0	\$10,228
15	\$7,706	\$0	\$7,706
16	\$12,564	\$0	\$12,564

Table 466: Nominal 30-year LSC Savings – Per Dwelling Unit – New Construction – Ventilation - Interior Closet – LoadedCorridor

Climate Zone	30-Year LSC Electricity Savings (Nominal \$)	30-Year LSC Natural Gas Savings (Nominal \$)	Total 30-Year LSC Savings (Nominal \$)
1	\$13,310	\$0	\$13,310
2	\$12,019	\$0	\$12,019
3	\$11,950	\$0	\$11,950
4	\$11,066	\$0	\$11,066
5	\$11,961	\$0	\$11,961
6	\$10,655	\$0	\$10,655
7	\$10,542	\$0	\$10,542
8	\$10,164	\$0	\$10,164
9	\$10,250	\$0	\$10,250
10	\$10,164	\$0	\$10,164
11	\$10,497	\$0	\$10,497
12	\$11,036	\$0	\$11,036
13	\$10,090	\$0	\$10,090
14	\$10,481	\$0	\$10,481
15	\$7,888	\$0	\$7,888
16	\$12,914	\$0	\$12,914

Table 467: Nominal 30-year LSC Savings – Per Dwelling Unit – New Construction – Ventilation - Interior Closet – LowRiseMixedUse

Climate Zone	30-Year LSC Electricity Savings (Nominal \$)	30-Year LSC Natural Gas Savings (Nominal \$)	Total 30-Year LSC Savings (Nominal \$)
1	\$13,105	\$0	\$13,105
2	\$11,836	\$0	\$11,836
3	\$11,750	\$0	\$11,750
4	\$10,882	\$0	\$10,882
5	\$11,777	\$0	\$11,777
6	\$10,473	\$0	\$10,473
7	\$10,351	\$0	\$10,351
8	\$9,997	\$0	\$9,997
9	\$10,080	\$0	\$10,080
10	\$9,991	\$0	\$9,991
11	\$10,315	\$0	\$10,315
12	\$10,843	\$0	\$10,843
13	\$9,919	\$0	\$9,919
14	\$10,304	\$0	\$10,304
15	\$7,759	\$0	\$7,759
16	\$12,672	\$0	\$12,672

Table 468: Nominal 30-year LSC Savings – Per Dwelling Unit – New Construction – Ventilation - Interior Closet – HighRiseMixedUse

Climate Zone	30-Year LSC Electricity Savings (Nominal \$)	30-Year LSC Natural Gas Savings (Nominal \$)	Total 30-Year LSC Savings (Nominal \$)
1	\$12,831	\$0	\$12,831
2	\$11,597	\$0	\$11,597
3	\$11,480	\$0	\$11,480
4	\$10,636	\$0	\$10,636
5	\$11,528	\$0	\$11,528
6	\$10,227	\$0	\$10,227
7	\$10,094	\$0	\$10,094
8	\$9,769	\$0	\$9,769
9	\$9,851	\$0	\$9,851
10	\$9,760	\$0	\$9,760
11	\$10,073	\$0	\$10,073
12	\$10,587	\$0	\$10,587
13	\$9,691	\$0	\$9,691
14	\$10,072	\$0	\$10,072
15	\$7,587	\$0	\$7,587
16	\$12,354	\$0	\$12,354

Table 469: Nominal 30-year LSC Savings – Per Dwelling Unit – New Construction – Ventilation - Interior Closet – SF500

Climate Zone	30-Year LSC Electricity Savings (Nominal \$)	30-Year LSC Natural Gas Savings (Nominal \$)	Total 30-Year LSC Savings (Nominal \$)
1	\$12,149	\$0	\$12,149
2	\$11,111	\$0	\$11,111
3	\$10,738	\$0	\$10,738
4	\$10,036	\$0	\$10,036
5	\$10,815	\$0	\$10,815
6	\$9,548	\$0	\$9,548
7	\$9,399	\$0	\$9,399
8	\$9,087	\$0	\$9,087
9	\$9,223	\$0	\$9,223
10	\$9,164	\$0	\$9,164
11	\$9,481	\$0	\$9,481
12	\$9,942	\$0	\$9,942
13	\$9,106	\$0	\$9,106
14	\$9,553	\$0	\$9,553
15	\$7,191	\$0	\$7,191
16	\$11,654	\$0	\$11,654

Table 470: Nominal 30-year LSC Savings – Per Dwelling Unit – New Construction – Ventilation - Interior Closet – SF2100

Climate Zone	30-Year LSC Electricity Savings (Nominal \$)	30-Year LSC Natural Gas Savings (Nominal \$)	Total 30-Year LSC Savings (Nominal \$)
1	\$15,573	\$0	\$15,573
2	\$14,032	\$0	\$14,032
3	\$14,149	\$0	\$14,149
4	\$13,098	\$0	\$13,098
5	\$13,987	\$0	\$13,987
6	\$12,663	\$0	\$12,663
7	\$12,642	\$0	\$12,642
8	\$11,999	\$0	\$11,999
9	\$12,121	\$0	\$12,121
10	\$12,066	\$0	\$12,066
11	\$12,495	\$0	\$12,495
12	\$13,150	\$0	\$13,150
13	\$11,966	\$0	\$11,966
14	\$12,420	\$0	\$12,420
15	\$9,312	\$0	\$9,312
16	\$15,575	\$0	\$15,575

Table 471: Nominal 30-year LSC Savings – Per Dwelling Unit – New Construction – Ventilation - Interior Closet – SF2700

Climate Zone	30-Year LSC Electricity Savings (Nominal \$)	30-Year LSC Natural Gas Savings (Nominal \$)	Total 30-Year LSC Savings (Nominal \$)
1	\$17,618	\$0	\$17,618
2	\$15,838	\$0	\$15,838
3	\$15,580	\$0	\$15,580
4	\$14,824	\$0	\$14,824
5	\$15,492	\$0	\$15,492
6	\$13,822	\$0	\$13,822
7	\$13,785	\$0	\$13,785
8	\$13,272	\$0	\$13,272
9	\$13,416	\$0	\$13,416
10	\$13,278	\$0	\$13,278
11	\$13,765	\$0	\$13,765
12	\$14,513	\$0	\$14,513
13	\$13,247	\$0	\$13,247
14	\$13,707	\$0	\$13,707
15	\$10,226	\$0	\$10,226
16	\$17,249	\$0	\$17,249

Table 472: Nominal 30-year LSC Savings – Per Dwelling Unit – Alterations – Ventilation - Interior Closet – LowRiseGarden

Climate Zone	30-Year LSC Electricity Savings (Nominal \$)	30-Year LSC Natural Gas Savings (Nominal \$)	Total 30-Year LSC Savings (Nominal \$)
1	\$13,035	\$0	\$13,035
2	\$11,743	\$0	\$11,743
3	\$11,703	\$0	\$11,703
4	\$10,816	\$0	\$10,816
5	\$11,742	\$0	\$11,742
6	\$10,430	\$0	\$10,430
7	\$10,303	\$0	\$10,303
8	\$9,974	\$0	\$9,974
9	\$10,039	\$0	\$10,039
10	\$9,938	\$0	\$9,938
11	\$10,251	\$0	\$10,251
12	\$10,780	\$0	\$10,780
13	\$9,867	\$0	\$9,867
14	\$10,228	\$0	\$10,228
15	\$7,706	\$0	\$7,706
16	\$12,564	\$0	\$12,564

Table 473: Nominal 30-year LSC Savings – Per Dwelling Unit – Alterations – Ventilation - Interior Closet – LoadedCorridor

Climate Zone	30-Year LSC Electricity Savings (Nominal \$)	30-Year LSC Natural Gas Savings (Nominal \$)	Total 30-Year LSC Savings (Nominal \$)
1	\$13,310	\$0	\$13,310
2	\$12,019	\$0	\$12,019
3	\$11,950	\$0	\$11,950
4	\$11,066	\$0	\$11,066
5	\$11,961	\$0	\$11,961
6	\$10,655	\$0	\$10,655
7	\$10,542	\$0	\$10,542
8	\$10,164	\$0	\$10,164
9	\$10,250	\$0	\$10,250
10	\$10,164	\$0	\$10,164
11	\$10,497	\$0	\$10,497
12	\$11,036	\$0	\$11,036
13	\$10,090	\$0	\$10,090
14	\$10,481	\$0	\$10,481
15	\$7,888	\$0	\$7,888
16	\$12,914	\$0	\$12,914

Table 474: Nominal 30-year LSC Savings – Per Dwelling Unit – Alterations – Ventilation - Interior Closet – MidRiseMixedUse

Climate Zone	30-Year LSC Electricity Savings (Nominal \$)	30-Year LSC Natural Gas Savings (Nominal \$)	Total 30-Year LSC Savings (Nominal \$)
1	\$13,105	\$0	\$13,105
2	\$11,836	\$0	\$11,836
3	\$11,750	\$0	\$11,750
4	\$10,882	\$0	\$10,882
5	\$11,777	\$0	\$11,777
6	\$10,473	\$0	\$10,473
7	\$10,351	\$0	\$10,351
8	\$9,997	\$0	\$9,997
9	\$10,080	\$0	\$10,080
10	\$9,991	\$0	\$9,991
11	\$10,315	\$0	\$10,315
12	\$10,843	\$0	\$10,843
13	\$9,919	\$0	\$9,919
14	\$10,304	\$0	\$10,304
15	\$7,759	\$0	\$7,759
16	\$12,672	\$0	\$12,672

Table 475: Nominal 30-year LSC Savings – Per Dwelling Unit – Alterations – Ventilation - Interior Closet – HighRiseMixedUse

Climate Zone	30-Year LSC Electricity Savings (Nominal \$)	30-Year LSC Natural Gas Savings (Nominal \$)	Total 30-Year LSC Savings (Nominal \$)
1	\$12,831	\$0	\$12,831
2	\$11,597	\$0	\$11,597
3	\$11,480	\$0	\$11,480
4	\$10,636	\$0	\$10,636
5	\$11,528	\$0	\$11,528
6	\$10,227	\$0	\$10,227
7	\$10,094	\$0	\$10,094
8	\$9,769	\$0	\$9,769
9	\$9,851	\$0	\$9,851
10	\$9,760	\$0	\$9,760
11	\$10,073	\$0	\$10,073
12	\$10,587	\$0	\$10,587
13	\$9,691	\$0	\$9,691
14	\$10,072	\$0	\$10,072
15	\$7,587	\$0	\$7,587
16	\$12,354	\$0	\$12,354

Table 476: Nominal 30-year LSC Savings – Per Dwelling Unit – Alterations – Ventilation - Interior Closet – SF500

Climate Zone	30-Year LSC Electricity Savings (Nominal \$)	30-Year LSC Natural Gas Savings (Nominal \$)	Total 30-Year LSC Savings (Nominal \$)
1	\$12,149	\$0	\$12,149
2	\$11,111	\$0	\$11,111
3	\$10,738	\$0	\$10,738
4	\$10,036	\$0	\$10,036
5	\$10,815	\$0	\$10,815
6	\$9,548	\$0	\$9,548
7	\$9,399	\$0	\$9,399
8	\$9,087	\$0	\$9,087
9	\$9,223	\$0	\$9,223
10	\$9,164	\$0	\$9,164
11	\$9,481	\$0	\$9,481
12	\$9,942	\$0	\$9,942
13	\$9,106	\$0	\$9,106
14	\$9,553	\$0	\$9,553
15	\$7,191	\$0	\$7,191
16	\$11,654	\$0	\$11,654

Table 477: Nominal 30-year LSC Savings – Per Dwelling Unit – Alterations – Ventilation - Interior Closet – SF2100

Climate Zone	30-Year LSC Electricity Savings (Nominal \$)	30-Year LSC Natural Gas Savings (Nominal \$)	Total 30-Year LSC Savings (Nominal \$)
1	\$15,573	\$0	\$15,573
2	\$14,032	\$0	\$14,032
3	\$14,149	\$0	\$14,149
4	\$13,098	\$0	\$13,098
5	\$13,987	\$0	\$13,987
6	\$12,663	\$0	\$12,663
7	\$12,642	\$0	\$12,642
8	\$11,999	\$0	\$11,999
9	\$12,121	\$0	\$12,121
10	\$12,066	\$0	\$12,066
11	\$12,495	\$0	\$12,495
12	\$13,150	\$0	\$13,150
13	\$11,966	\$0	\$11,966
14	\$12,420	\$0	\$12,420
15	\$9,312	\$0	\$9,312
16	\$15,575	\$0	\$15,575

Table 478: Nominal 30-year LSC Savings – Per Dwelling Unit – Alterations – Ventilation - Interior Closet – SF2700

Climate Zone	30-Year LSC Electricity Savings (Nominal \$)	30-Year LSC Natural Gas Savings (Nominal \$)	Total 30-Year LSC Savings (Nominal \$)
1	\$17,618	\$0	\$17,618
2	\$15,838	\$0	\$15,838
3	\$15,580	\$0	\$15,580
4	\$14,824	\$0	\$14,824
5	\$15,492	\$0	\$15,492
6	\$13,822	\$0	\$13,822
7	\$13,785	\$0	\$13,785
8	\$13,272	\$0	\$13,272
9	\$13,416	\$0	\$13,416
10	\$13,278	\$0	\$13,278
11	\$13,765	\$0	\$13,765
12	\$14,513	\$0	\$14,513
13	\$13,247	\$0	\$13,247
14	\$13,707	\$0	\$13,707
15	\$10,226	\$0	\$10,226
16	\$17,249	\$0	\$17,249

Appendix H: Energy Impact Analysis Methodology Details

Recirculation Heat Loss Spreadsheet Calculator

The Statewide CASE Team used a custom spreadsheet calculator to analyze the energy impacts of the DHW distribution measures. The spreadsheet calculator was developed by the 2022 Title 24 Statewide CASE Team based on a recirculation system model developed by a CEC funded research on multifamily DHW distribution systems¹¹⁹, pipe heat loss calculation methods defined in the current Title 24 ACM Reference Manual (developed during the 2013 Title 24 Code Cycle), and a 2021 CEC funded research on residential DHW distribution systems¹²⁰. The Statewide CASE Team made necessary improvements to the spreadsheet calculator to support energy impact analysis of the proposed 2025 code changes. Compared to CBECC-Res software, the spreadsheet calculator includes features to handle detailed recirculation designs, insulation conditions, and recirculation flow controls. This spreadsheet calculator enables the Statewide CASE Team to assess the energy impact of energy efficiency measures that have not been incorporated into Title 24 ACM Reference Manual and CBECC. The overall modeling approach, features, and related assumptions of the spreadsheet calculator are described in following sections.

Recirculation Piping Network Configurations

Recirculation-based DHW distribution systems in multifamily buildings include complicated piping configurations, as shown by recirculation system plumbing designs for prototype buildings in Appendix I. The existing Title 24 ACM Reference Manual and CBECC-Res software use six pipe sections connected in series to model recirculation systems. The six-pipe section recirculation model was designed as a practical recirculation performance model to simplify the compliance process by not requiring builders to specify detailed plumbing configurations in the compliance model. However, this modeling approach is not adequate to model complicated recirculation designs in real buildings. The recirculation heat loss spreadsheet calculator uses detailed and full recirculation piping configurations to assess energy impacts of realistic recirculation

¹¹⁹ Zhang, Yanda. (Heschong Mahone Group). 2013. Multifamily Central Domestic Hot Water Distribution Systems. California Energy Commission. Publication Number: CEC-500-2013-011.

¹²⁰ Klein, Gary, Jim Lutz, Yanda Zhang, and John Koeller, 2021. Code Changes and Implications of Residential Low-Flow Hot Water Fixtures. California Energy Commission. Publication Number: CEC-500-2021-043.

designs and, therefore, enables accurate assessment of energy impacts of proposed code change measures.

In the recirculation heat loss spreadsheet calculator, a recirculation system is represented as a collection of pipe sections connected to each other according to actual designs of the recirculation system. There is no limit on the number of pipe sections and both serial and parallel flow paths (e.g., those through vertical risers) are allowed. The Statewide CASE Team developed detailed pipe section configurations to reflect full recirculation piping designs of the four prototype multifamily buildings. As shown by recirculation system designs presented in Appendix I, starting from the central water heater plant and following the recirculation flow paths, the recirculation system splits into parallel risers, which provide hot water to pipe branches into individual dwelling units. Riser pipes funnel back into recirculation return pipes through parallel return pipes. In the spreadsheet calculator, pipe sections and major pipe connectors are identified by unique indices. The number of unique pipe sections for the four prototype buildings are as follows:

- Low-Rise Garden: 12 pipe sections
- Low-Rise Loaded Corridor: 57 pipe sections
- Mid-Rise Mixed Use: 112 pipe sections
- High-Rise Mixed Use: 138 pipe sections

Specifications of each pipe section include pipe size (diameter), length, insulation thickness, index of the beginning pipe connector, and index of the ending pipe connector. The spreadsheet calculator uses specifications of the beginning and ending pipe connectors of all pipe sections to determine the recirculation network topology. Some pipe connectors are connected to a branch pipe leading to hot water fixtures in a dwelling unit. These pipe connectors have a hot water draw schedule. The calculator determines flow rate for each pipe section based on the recirculation network topology, recirculation pump operation status, and hot water schedules of pipe connectors.

Heat Loss Calculation Steps

For each time step, the calculator starts pipe section analysis from the first pipe section - the supply pipe connected to the central water heater - to obtain pipe heat loss, average output water temperature, and average pipe temperature at the end of the time step. The average output water temperature is then used as the input water temperature for the downstream pipe section(s). A pipe section analysis is performed for each pipe section following recirculation flow paths.

According to the 2022 ACM Reference Manual, recirculation pipes can have two modes of heat loss: pipe heat loss with hot water flow in the pipe and heat loss without flow in the pipe. The latter is also called cooldown mode, and it takes place when the recirculation pump is turned off by a control and there is no hot water draw by users.

When there is flow in the pipe section, due to recirculation operation and/or hot water draws, pipe heat loss is calculated according to the ACM Reference Manual for pipe heat loss with flows. If there is no flow in the pipe section, pipe heat loss is calculated according to the ACM Reference Manual for pipe cooldown process. CEC staff indicated that demand controls of recirculation systems should not be included in energy impact analysis because of concerns that these controls have not been widely adopted to achieve the intended energy savings. Therefore, recirculation pump is on all the time and there is no pipe cooldown process.

For each time step of heat loss calculation, the calculator performs heat loss calculation for each pipe section following the flow path, starting from the pipe section connected to the central water heater. Total recirculation system pipe heat loss for each time step is the sum of pipe heat loss from all pipe sections. For each pipe section, the calculator obtains pipe heat loss, average output water temperature, and average pipe temperature at the end of the time step. The average output water temperature is then used as the input water temperature for the downstream pipe section(s). For pipe sections with multiple upstream pipe sections, the sum of water flows and average output water temperature of upstream pipe sections are used as the input condition. Average pipe section temperature at the end of each time step of calculation is used as the initial pipe section temperature for the next time step of heat loss calculation. The Statewide CASE Team performed hourly heat loss calculation to support annual impact analysis.

Ambient Temperatures

Building indoor temperatures represent ambient temperatures of the recirculation systems because most or all recirculation pipes inside indoor spaces. The Statewide CASE Team calculated the indoor space temperature for each climate zone based on the weather data provided in CBECC. The rules for this calculation are presented in Table 22 and Section 2.5.4.3 of the 2022 Title 24, Part 6 Residential ACM, and summarized as follows:

- Heating and cooling mode are determined by calculating the rolling average outdoor temperature for the previous eight days.
 - The building is in cooling mode if the rolling average is greater than 60°F.
 - The building is in heating mode if the average is equal to or less than 60°F.
 - Hourly thermostat setpoints vary between 78°F and 83°F (nighttime/daytime) in cooling mode and 65°F and 68°F (nighttime/daytime) in heating mode.
 - Table 479 presents the yearly hours in heating and cooling mode, and average indoor temperature by climate zone.

- The purpose of this exercise is to determine the hourly indoor temperature schedule to calculate heat loss from the distribution system. All DHW distribution pipes are assumed to be within the conditioned envelope.

Table 479: Heating and Cooling Mode and Average Indoor Temperature by Climate Zone

Climate Zone	Hours in Heating Mode	Hours in Cooling Mode	Average Indoor Temp [F]
1	8,760	0	67.0
2	5,182	3,578	72.2
3	5,525	3,235	71.7
4	4,785	3,975	72.7
5	7,205	1,555	69.2
6	4,305	4,455	73.4
7	3,562	5,198	74.5
8	3,380	5,380	74.8
9	3,595	5,165	74.5
10	3,867	4,893	74.1
11	4,556	4,204	73.1
12	4,566	4,194	73.1
13	4,230	4,530	73.5
14	4,423	4,337	73.3
15	1,706	7,054	77.2
16	5,610	3,150	71.6

Hot Water Draw Schedules

CBECC-Res software provides ten sets of annual fixture water use schedules for six types of multifamily dwelling units: studio and one-bedroom to five-bedroom units. These draw schedules were used to develop hot water draw schedules for the four prototype buildings in the following steps.

First, CBECC-Res annual fixture water use schedules are converted to annual hot water draw schedules. CBECC-Res annual fixture water use schedules specify the combined hot and cold-water mixture flow rate for each draw event. The Statewide CASE Team generated hot water draw schedules by multiplying the fixture flow rate of each draw

event by the corresponding hot water fraction, which were developed by the 2021 CEC research project on residential hot water distribution systems¹²¹, listed below:

- All faucet draws include 50 percent hot water.
- All draws from clothes washing machines include 22 percent hot water.
- All draws from showers and bathtubs have a mixed water temperature of 105°F. Corresponding hot water fraction is calculated based on the hot water supply temperature (125°F) and cold-water or mains temperature (obtained from CBECC-Res weather files)

As cold-water temperature changes, showers and bathtubs require different hot water flow rates to maintain the fixture output temperature of 105°F. Because the 16 climate zones have different cold-water temperatures, they have slightly different hot water flow rates for shower and bathtub use events, even though fixture flow rates are the same for these events among all climate zones. The hot water flow rate difference can be up to 20 percent. However, because shower and bathtub hot water draw volumes represent approximately one third of the total hot water use, the differences in hourly hot water flows among the 16 climate zones are much smaller. Also, the impact of hot water flow rate on pipe heat loss is a secondary factor compared to the primary factors of hot water temperature and ambient temperature. Also, when there is a recirculation flow, the influence of hot water draw flow rate is reduced. Therefore, differences in shower and bathtub flow rates among the 16 climate zones have little impact on recirculation system heat loss.

Second, for each dwelling unit, one hot water draw schedule is randomly designated from the ten CBECC-Res hot water draw schedules for the corresponding dwelling unit type. This is done for every dwelling unit in the prototype buildings.

Third, the selected hot water draw schedule for each dwelling unit is converted from individual draw events to hourly draw schedules to support hourly recirculation pipe heat loss calculation. For each hour, total hot water volume was calculated by summing up hot water draw volumes of all draw events within the hour.

Pipe Insulation Conditions

The recirculation pipe heat loss calculation method defined in the 2022 Title 24 ACM Reference Manual includes an adjustment factor of 2.0, which doubles the pipe heat

¹²¹ Klein, Gary, Jim Lutz, Yanda Zhang, and John Koeller, 2021. Code Changes and Implications of Residential Low-Flow Hot Water Fixtures. California Energy Commission. Publication Number: CEC-500-2021-043.

loss based on perfect pipe insulation. This adjustment factor, based on a prior CEC field study¹²² reflects imperfect pipe insulation due to the following three main effects:

- 2022 Title 24 does not explicitly require insulation of appurtenances in multifamily DHW recirculation systems.
- Branch pipes connecting recirculation pipes and hot water fixtures lead to additional pipe heat loss not captured by pipe heat loss calculation methods provided in the 2022 Title 24 ACM Reference Manual. Insulating branch pipes can reduce the additional heat loss but cannot eliminate it.
- Straight pipes are required to be insulated. However, without rigorous inspection and verification, insulation usually does not meet the insulation performance defined by the theoretical pipe heat loss calculation formula.

The Statewide CASE Team used an alternative heat loss adjustment method to reflect the above effects. In the recirculation heat loss spreadsheet calculator, the heat loss adjustment factor was set to 1.0, which means no adjustment was made to the pipe heat loss calculated based on the theoretical pipe heat loss. At the same time, the Statewide CASE Team assumed a certain amount of the recirculation pipes was effectively not insulated due to imperfect pipe insulation. For the base case, the number of insulated pipes was set at the level to achieve the same recirculation pipe heat loss as applying an adjustment factor of 2.0. Therefore, the base case based on this alternative heat loss adjustment method represents the same level of performance defined by the 2022 Title 24 ACM Reference Manual. The reason for using this alternative heat loss adjustment method is to enable simplified assumptions for the proposed code change on pipe insulation enhancement as described in Section 4. The amount of recirculation pipes not insulated in the base case is listed in Table 480. These levels of uninsulated pipes were used for the proposed case of requiring pipe sizing based on CPC Appendix M because this proposed change does not affect pipe insulation requirements.

Table 480: Amount of Recirculation Pipes Not Insulated in the Base Case

LowRiseGarden	LoadedCorridor	MidRiseMixedUse	HighRiseMixedUse
52%	43%	38.5%	43%

Treatment of Climate Zones

Weather conditions affect recirculation system pipe heat loss in two ways. First, as discussed in the “Hot Water Draw Schedules” section in this appendix, differences in

¹²² Zhang, Yanda. (Heschong Mahone Group). 2013. Multifamily Central Domestic Hot Water Distribution Systems. California Energy Commission. Publication Number: CEC-500-2013-011.

cold-water temperature led to different hot water flow rates for shower and bathtub draws because a different amount of hot water is needed for mixing with the cold-water to achieve the same fixture output temperature of 105°F. As discussed in that section, the resulting hot water flow rate differences have negligible impact on overall recirculation distribution heat loss. Second, weather conditions indirectly influence recirculation pipe heat loss by affecting building indoor temperature, which is the ambient temperature of recirculation pipes. Indoor temperature control settings are slightly different between heating and cooling modes. Because heating and cooling schedules, affected by weather conditions, are different among the sixteen climate zones, the corresponding indoor temperature schedules are different, as discussed in the “Ambient Temperatures” section in this appendix.

The Statewide CASE Team used the Loaded Corridor prototype building to assess the sensitivity of energy savings to climate zone. The Statewide CASE Team calculated recirculation heat loss for proposed cases for the loaded corridor prototype building in Climate Zone 3, 9, 12, and 15, which represent mild, heating-dominated, balanced heating and cooling, and cooling dominated climate zones. The Statewide CASE Team found that the percentage energy savings for Appendix M pipe sizing and insulation enhancement measures were nearly the same among these four climate zones. Percentage energy savings for the balancing valve measure (with 120°F temperature setting) varied in the range of 8.0 percent to 8.7 percent, which is small. This sensitivity analysis indicates that savings are not sensitive to climate zone, so the Statewide CASE Team chose not to model all 16 climate zones. CBECC was used to model DHW system energy use for the proposed case with digital MMV for all climate zones and base case DHW system energy use was calculated for each climate zone without MMV based on laboratory testing.

For each prototype multifamily building, the Statewide CASE Team assessed recirculation system performance for the baseline design and four proposed cases. If modeling analyses were performed for all 16 climate zones, 320 model runs would be needed. The recirculation model for the low-rise prototype is relatively simple and takes approximately four hours to complete, while the recirculation model for the high-rise prototype is much more complicated and takes approximately 12 hours to complete. With an average runtime of six hours per performance scenario, it would require 1920 hours or 80 days of computing time to complete all simulation runs.

Based on the above energy impact sensitivity analysis results, the Statewide CASE Team simplified the energy impact assessment for other climate zones and prototype buildings. For other prototype buildings, the Statewide CASE Team evaluated recirculation heat loss for base case and proposed cases in Climate Zone 3, 9, 12, and 15. An average percentage energy savings was obtained for each proposed case and prototype building based on the percentage energy savings of these four climate zones.

Base case recirculation heat loss in other climate zones was calculated by multiplying the recirculation heat loss in Climate Zone 3 by the corresponding ratio presented in Sections 3.3.1, 4.3.1., and 5.3.1. Energy savings in other climate zones were calculated based on the corresponding base case energy impact and the corresponding average percentage energy savings. This approach significantly reduced the amount resources needed to perform energy impact analysis for all climate zones.

Plant Pipe Heat Loss Calculator

The Statewide CASE Team developed a spreadsheet calculator to estimate pipe heat loss of water heating plants. Pipe heat loss calculation method defined in the 2022 Title 24 ACM Reference Manual for DHW systems requires information on hot water flow rate and temperature inside the pipe. In water heating plants, water flow rates and temperatures in pipes depend on heating equipment controls and storage tank performance characteristics, neither of which can be effectively modelled with existing modeling tools. To overcome this challenge, the Statewide CASE Team used an average pipe surface temperature to represent the average pipe operation condition. Therefore, compared to the recirculation heat loss calculator, the plant pipe heat loss calculator uses a simplified heat loss calculation approach. Using the fundamental heat transfer formula, pipe heat loss was calculated as the product of heat transfer coefficient ($UA\Delta T$) and the difference between pipe temperature and ambient temperature. Pipe heat transfer coefficient was calculated based the method defined in 2022 Title 24 ACM Reference Manual.

The Statewide CASE Team assumed that the average pipe surface temperature was 125°F, which is the hot water supply temperature defined in the 2022 Title 24 ACM Reference Manual. In both HPWH and gas boiler plants, water heating equipment usually uses a setpoint higher than the supply temperature to ensure storage tanks can be heated to this temperature level. In water heating plants using a MMV to regulate hot water supply temperature, the stored hot water is hotter than 125°F. Therefore, in most water heating plants, pipe surface temperature is higher than 125°F when there are hot water flows in the pipe. When there is no hot water flow, the pipe may cool down to be below 125°F. As shown by many field studies, multifamily buildings experience frequent hot water draws, except a brief period during the middle of the night. Pipes in water heating plants have very frequent hot water flows and very limited chances of extended cooldown periods. Therefore, it is reasonable, probably conservative, to assume the average pipe surface temperature is 125°F.

Pipe ambient temperature depends on installation location and weather conditions. Water heating plants can be installed in an unconditioned mechanical room, in an outdoor space, or partially in an unconditioned space and partially in an outdoor space. These installation spaces have a large range of possible air temperature. It is very

difficult to develop an hourly ambient temperature schedule to represent the “typical” ambient condition for water heating plants. The Statewide CASE Team decided to use an average ambient temperature of 67.5°F to assess plant pipe heat loss.

For each multifamily prototype, the Statewide CASE Team designed HPWH-based and a gas boiler-based water heating plants to serve the building. For each plant design, the Statewide CASE Team developed separate piping designs according to CPC Appendix A and Appendix M pipe sizing methods. Each of these designs provides a list of straight pipes and appurtenances to be used by each plant. The Statewide CASE Team grouped straight pipes and appurtenances according to their sizes (diameter). For heat loss calculation, each appurtenance was converted to a piece of straight pipe with equivalent pipe surface area. Table 481 summarized the equivalent pipe lengths by pipe diameter of each appurtenance type based on appurtenance length, shape and material. The equivalent length factors shown in Table 481 were multiplied by the BOD appurtenance quantities to determine the appurtenances equivalent pipe length that needed to be added to the heating plant thermal loss model. Note that not all factors shown below were utilized in the calculations as only certain sized of appurtenances were in the BOD counts. The Statewide CASE Team further developed insulation conditions, in terms of percentage of pipes not insulated, for the base case and the proposed insulation enhancement case.

For each scenario of plant heat loss analysis, the Statewide CASE Team used the calculator to calculate heat loss for each straight pipe group and each appurtenance equivalent pipe length group. The sum of heat loss from all pipe and appurtenance groups is the total plant pipe heat loss.

Table 481: Appurtenance Length and Equivalent Pipe Length by Pipe Diameter

Appurtenance	Data Source	Data Type	0.5"	0.75"	1"	1.25"	1.5"	2"	2.5"	3"	4"	5"	6"
Master Mixing Valve	Leonard Valve Spec Sheets	Appurtenance Length (in)	0	0	22	0	25	28	0	31	0	0	0
		Equivalent Length (in)	0	0	69.3	0	78.75	88.2	0	97.65	0	0	0
Ball Valve	Apollo® 77C-A Series Submittal Sheet	Appurtenance Length (in)	2.47	3.2	3.81	4.21	4.9	6.07	7.17	7.99	9.01	14.01	15.5
		Equivalent Length (in)	4.94	6.4	7.62	8.42	9.8	12.14	14.34	21.97	24.78	38.53	42.63
Balancing Valve	Bell & Gossett Submittal A-549G	Appurtenance Length (in)	3	3.5	4.25	4.9	5.22	6.31	6	6.5	0	0	0
		Equivalent Length (in)	6.9	8.05	9.775	11.27	12.01	14.51	13.8	14.95	0	0	0
Pressure Relief Valve	Watts 25AUB-Z3 Submittal Sheet	Appurtenance Length (in)	6.44	6.5	7.38	10.75	10.75	11.69	0	0	0	0	0
		Equivalent Length (in)	22.5	22.75	25.83	37.63	37.63	40.92	0	0	0	0	0
Spring Check Valve	Jomar valve S-521G Submittal sheet	Appurtenance Length (in)	2.09	2.54	2.97	3.12	3.6	4.33	0	10.25	11.82	13.8	15.75
		Equivalent Length (in)	5.93	6.83	7.69	7.99	8.95	10.41	0	22.25	25.39	29.35	33.25
Wye Strainer (20 Mesh)	APALLO 59-300 Series Submittal Sheet	Appurtenance Length (in)	2.75	4	4.75	5.25	6	7.25	11.75	13	15.5	17.5	20
		Equivalent Length (in)	9.63	14	16.63	18.38	21	25.38	47	52	62	70	80
Hose Bibb	Legend Model T-537	Appurtenance Length (in)	3.3	3.7	4	4	4	4	4	4	4	4	4
		Equivalent Length (in)	9.34	10.49	11.4	11.44	11.47	11.57	11.66	11.75	11.9	12.03	12.16
Long-Radius 90	Nibco 607-LT	Appurtenance Length (in)	0.91	1.13	1.44	1.88	2.25	2.94	3.75	4.03	5.25	5.5	5.75
		Equivalent Length (in)	1.59	1.978	2.52	3.29	3.94	5.15	6.56	7.05	8.42	9.96	11.48
Copper Tee	Nibco 611 Tee	Appurtenance Length (in)	0.69	0.88	1.38	1.63	1.88	2.56	3.13	3.75	4.81	5.69	6.56
		Equivalent Length (in)	1.21	1.54	2.415	2.85	3.29	4.48	5.48	6.56	8.42	9.96	11.48
Manual Vent (reducing tee to 1/2" ball valve)		Appurtenance Length (in)	3.99	4.18	4.68	4.93	5.18	5.86	6.43	7.05	0	0	0
		Equivalent Length (in)	9.08	9.51	10.65	11.22	11.78	13.33	14.63	16.04	0	0	0
Straight Copper Pipe	NA	Appurtenance Length (in)	1	1	1	1	1	1	1	1	1	1	1
		Equivalent Length (in)	NA	NA	NA	NA	NA	NA	NA	NA	NA	NA	NA
Dielectric Union	Wilkins Model DUC Submittal Sheet	Appurtenance Length (in)	1.81	2	2.25	2.41	2.5	2.94	3.63	3.63	4	4.2	4.4
		Equivalent Length (in)	3.26	3.6	4.05	4.338	4.5	5.29	6.53	6.53	7.2	7.56	7.92
Pump		Appurtenance Length (in)	5.5	6.5	6.38	0	0	0	0	0	0	0	0
		Equivalent Length (in)	19.5	19.5	19.14	0	0	0	0	0	0	0	0

Water Heating Plant Efficiency

Site energy consumption associated with recirculation system and water heating plant pipe heat loss is calculated by dividing hourly pipe heat loss by the efficiency of the water heating plant. Based on the 2022 Title 24 ACM Reference Manual, the Statewide CASE Team used an 80 percent thermal efficiency for the gas boiler per minimum efficiency required by the California Appliance Efficiency Standards (Title 20. The efficiency of HPWH plant is 3.0).

Appendix I: Prototypes and Basis of Design CPC

Appendix A Pipe Sizing Methodology

The Statewide CASE Team developed DHW systems plumbing designs for the different prototype multifamily buildings: low-rise garden style, low-rise loaded corridor, mid-rise mixed use, and high-rise mixed use by following CPC Appendix A sizing methodology. Figure 26 through Figure 29 and Table 482 through Table 486 represent the specifications of these designs.

The resulting prototype designs were then used to model energy use for the proposed Master Mixing Valve (base case), CPC Appendix M Pipe Sizing (base case), Pipe Insulation Enhancement, and Require Balancing valves measures. The Energy Impact Analysis Methodology for these measures can be reviewed in Appendix H.

Additionally, the prototype designs were used to collect costs for the proposed CPC Appendix M pipe (base case), and Pipe Insulation Enhancement measures. An example of the proposed CPC Appendix M Pipe Sizing (base case) measure raw cost data collected from the contractors can be found in Table 488. Additionally, examples of the proposed Enhanced Pipe Insulation measure can be found in Table 489 and Table 490.

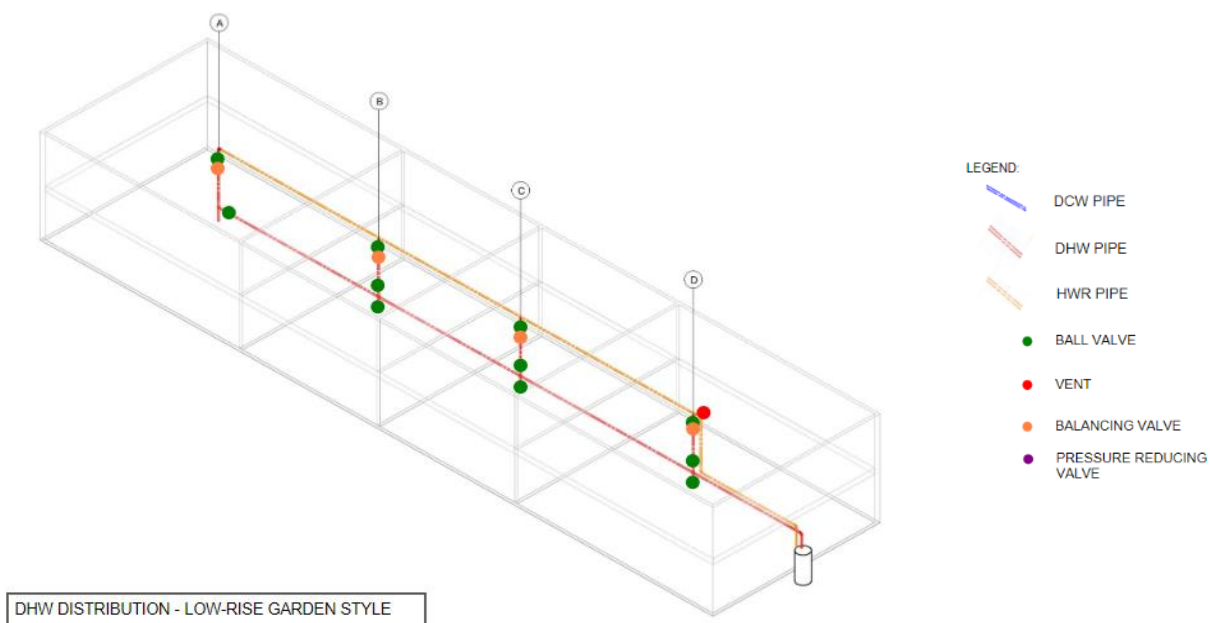

Figure 26: Low-rise garden style domestic hot water piping schematic with appurtenance locations.

**Table 482: Low-Rise Garden Style Domestic Hot Water Pipe Length by Diameter
CPC Appendix A Specifications**

Diameter (inches)	Primary Main	Horizontal	Recirc	Riser A	Riser B	Riser C	Riser D	Total (ft)
3	n/a	n/a	n/a	0	0	0	0	0
2.5	n/a	n/a	n/a	0	0	0	0	0
2	20	n/a	n/a	0	0	0	0	20
1.5	58	n/a	n/a	0	0	0	0	58
1	29	n/a	n/a	0	0	0	0	29
0.75	n/a	n/a	114	13.5	13.5	13.5	13.5	168

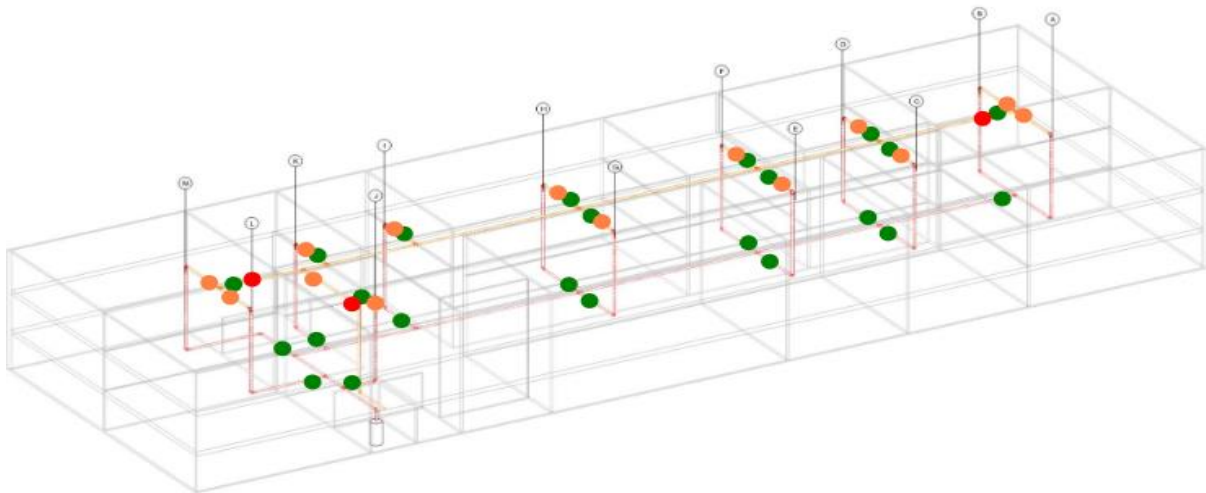

Figure 27: Low-rise loaded corridor domestic hot water piping schematic with appurtenance locations.

Table 483: Low-Rise Loaded Corridor Domestic Hot Water Pipe Length by Diameter CPC Appendix A Specifications

Diameter (inches)	Primary Main	Horizontal	Recirc	Riser A-H	Riser I-K	Riser L,M	Total (ft)
3	25	n/a	n/a	0	0	0	25
2.5	90	n/a	n/a	0	0	0	90
2	24	n/a	n/a	0	0	0	24
1.5	26	127	n/a	0	0	0	153
1	n/a	25	40	9	9	9	182
0.75	n/a	n/a	287	13.5	9	13.5	449

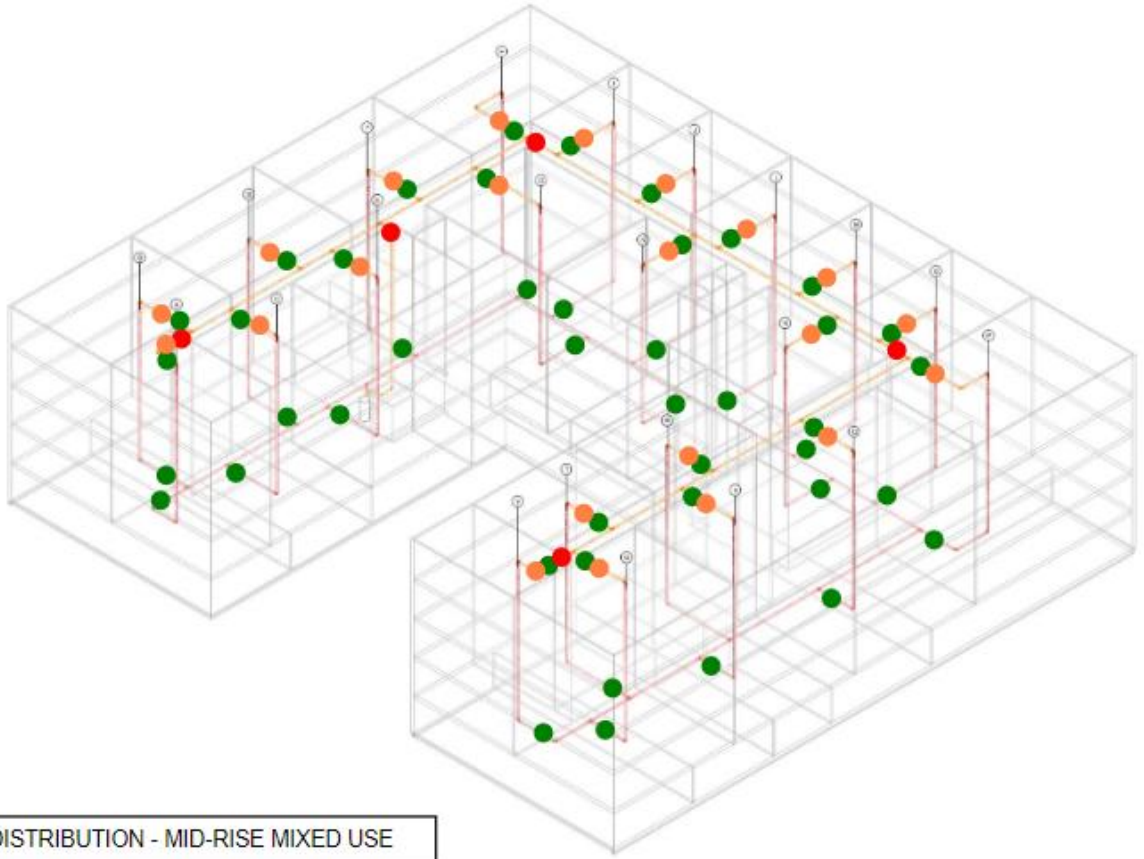
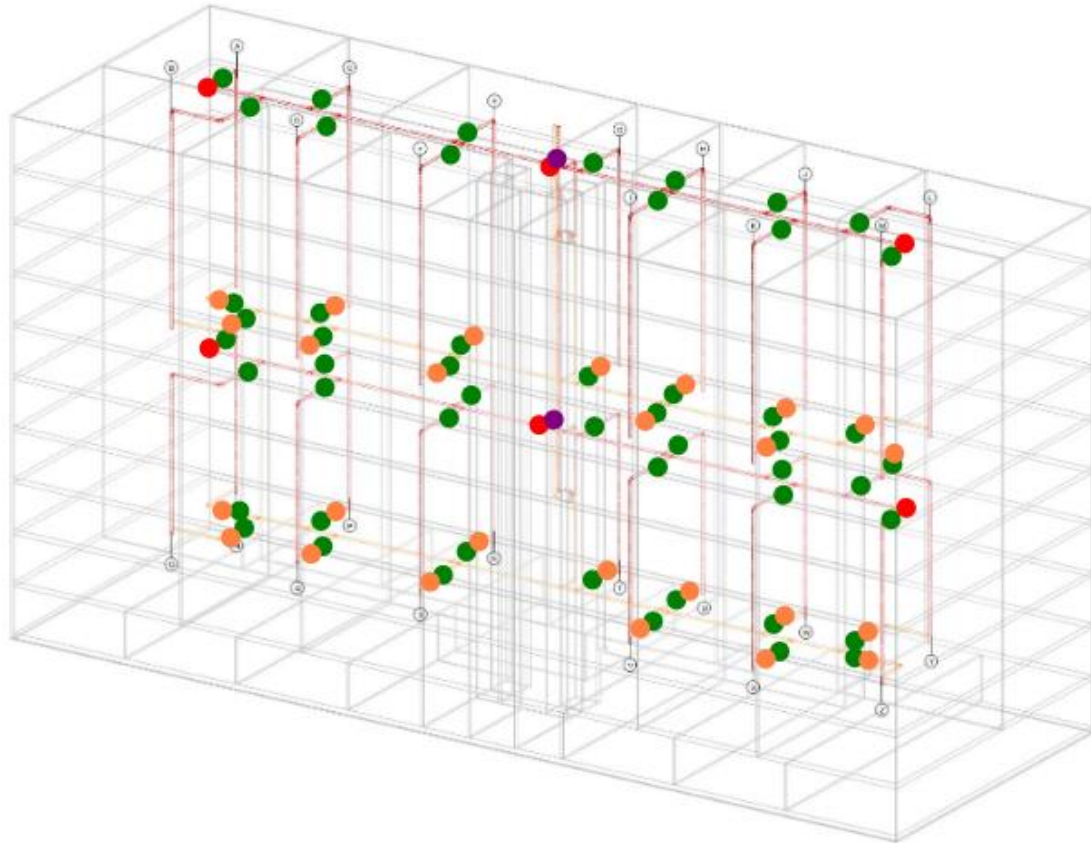

Figure 28: Mid-rise domestic hot water piping schematic with appurtenance locations.

Table 484: Mid-Rise Domestic Hot Water Pipe Length by Diameter CPC Appendix A Specifications

Diameter (inches)	Primary Main	Horizontal	Recirc	Riser A-V	Total (ft)
4	53	n/a	n/a	0	53
3	91	n/a	n/a	0	91
2.5	73	n/a	n/a	0	73
2	85	n/a	n/a	0	85
1.5	n/a	341	48	25	939
1	n/a	n/a	118	10	338
0.75	n/a	n/a	524	10	744



DHW DISTRIBUTION - HIGH RISE MIXED USE

Figure 29: High-rise domestic hot water piping schematic with appurtenance locations.

Table 485: High-Rise Domestic Hot Water Pipe Length by Diameter CPC Appendix A Specifications

Diameter (inches)	Primary Main	Horizontal	Recirc	Main Riser	Recirc Riser	Riser A-M	Riser N-Z	Total (ft)
4	4	n/a	n/a	5	n/a	0	0	9
3	5	n/a	n/a	62	63	0	0	130
2.5	165	n/a	n/a	n/a	n/a	0	0	165
2	58	n/a	n/a	n/a	n/a	0	0	58
1.5	n/a	392	n/a	n/a	n/a	20	10	782
1	n/a	n/a	53	n/a	n/a	10	10	313
0.75	n/a	n/a	628	n/a	n/a	15	15	1018
0.5	n/a	n/a	n/a	n/a	n/a	0	0	0

Table 486: CPC Appendix A Gas Heating Plant Appurtenance Counts and Straight Pipe Length Appendix A

Building Type	Pipe Diameter (in)	Master Mixing Valve	Ball Valve	Balancing Valve	T & P Relief Valve	Check Valve	Wye/Strainer	Hose Bib	90	Tee	Vent	Straight Pipe (ft)	Dielectric Union	Circ. Pump
Low-Rise Garden Style	0.5	0	0	0	0	0	0	0	0	0	0	0	0	0
	0.75	0	5	2	0	4	0	1	0	2	1	12	0	1
	1	1	0	0	2	0	0	0	0	0	0	0	0	0
	1.5	0	3	0	0	1	2	2	15	7	0	36	1	1
	2	0	6	0	0	1	1	0	15	1	2	44	8	0
	2.5	0	0	0	0	0	0	0	0	0	0	0	0	0
	3	0	0	0	0	0	0	0	0	0	0	0	0	0
Low-Rise Loaded Corridor	0.5	0	0	0	0	0	0	0	0	0	0	0	0	0
	0.75	0	6	0	0	0	0	0	0	0	0	0	0	0
	1	0	0	2	3	3	0	1	0	1	1	12	0	1
	1.5	1	0	0	0	0	0	0	0	0	0	0	0	0
	2	0	5	0	0	3	4	4	19	3	0	36	1	2
	2.5	0	0	0	0	0	0	0	0	0	0	0	0	0
	3	0	8	0	0	1	1	0	22	11	2	62	11	0
Mid-Rise Mixed Use	0.5	0	0	0	0	0	0	0	0	0	0	0	0	0
	0.75	0	5	0	0	0	0	0	0	0	0	0	0	0
	1	0	0	0	4	0	0	0	0	0	0	0	0	0
	1.5	0	0	0	0	0	0	0	0	0	0	0	0	0
	2	0	2	2	0	4	0	1	0	2	1	12	0	1
	2.5	0	0	0	0	0	0	0	0	0	0	0	0	0
	3	2	7	0	0	3	6	6	27	4	0	48	1	3
	4	0	10	0	0	1	1	0	25	14	2	68	14	0
High-Rise Mixed Use	0.5	0	0	0	0	0	0	0	0	0	0	0	0	0
	0.75	0	7	0	0	0	0	0	0	0	0	0	0	0
	1	0	4	4	6	6	0	2	0	0	2	24	0	2
	1.5	0	0	0	0	0	0	0	0	0	0	0	0	0
	2	4	2	0	0	2	0	0	6	2	0	24	2	0
	2.5	0	0	0	0	0	0	0	0	0	0	0	0	0
	3	0	6	0	0	3	6	6	24	4	0	36	0	3
	4	0	4	0	0	0	0	0	14	19	0	52	4	0
	5	0	0	0	0	0	0	0	0	0	0	0	0	0
	6	0	12	0	0	1	2	0	26	1	2	48	18	0

Table 487: CPC Appendix A HPWH Plant Appurtenance Counts and Straight Pipe Length CPC Appendix A

Prototype	Pipe Diameter (in)	Master Mixing Valve	Ball Valve	Balancing Valve	T & P Relief Valve	Check Valve	Wye/Strainer	Hose Bib	90	Tee	Vent	Straight Pipe (ft)	Dielectric Union	Circ. Pump
Low-Rise Garden Style	0.5	0	2	0	0	1	1	2	12	2	0	24	0	0
	0.75	0	5	2	0	4	0	1	0	2	1	12	0	1
	1	1	0	0	2	0	0	0	0	0	0	0	0	0
	1.5	0	1	0	0	0	0	0	3	0	0	12	1	0
	2	0	6	0	0	1	1	0	21	2	2	56	6	0
	2.5	0	0	0	0	0	0	0	0	0	0	0	0	0
	3	0	0	0	0	0	0	0	0	0	0	0	0	0
Low-Rise Loaded Corridor	0.5	0	10	0	0	5	5	10	40	8	0	48	0	0
	0.75	0	5	0	0	0	0	0	4	0	0	12	0	0
	1	0	0	2	2	3	0	1	0	1	1	12	0	1
	1.5	1	0	0	0	0	0	0	0	0	0	0	0	0
	2	0	1	0	0	1	0	0	3	1	0	12	1	0
	2.5	0	0	0	0	0	0	0	0	0	0	0	0	0
	3	0	6	0	0	1	1	0	21	2	2	56	6	0
Mid-Rise Mixed Use	0.5	0	0	0	0	0	0	0	0	0	0	0	0	0
	0.75	0	4	0	0	0	0	0	0	0	0	0	0	0
	1	0	8	0	3	2	2	8	16	4	0	24	0	2
	1.5	0	0	0	0	0	0	0	4	0	0	12	0	0
	2	0	2	2	0	4	0	1	0	2	1	12	0	1
	2.5	0	0	0	0	0	0	0	0	0	0	0	0	0
	3	2	1	0	0	0	0	0	3	0	0	12	1	0
	4	0	8	0	0	1	1	0	27	2	3	68	8	0
High-Rise Mixed Use	0.5	0	0	0	0	0	0	0	0	0	0	0	0	0
	0.75	0	5	0	0	0	0	0	0	0	0	0	0	0
	1	0	12	4	4	8	2	10	16	4	2	48	0	4
	1.5	0	0	0	0	0	0	0	4	0	0	12	0	0
	2	4	2	0	0	2	0	0	6	2	0	24	2	0
	2.5	0	0	0	0	0	0	0	0	0	0	0	0	0
	3	0	0	0	0	0	0	0	12	0	0	0	0	0
	4	0	8	0	0	0	0	0	22	2	2	64	8	0
	5	0	0	0	0	0	0	0	0	0	0	0	0	0
	6	0	4	0	0	1	2	0	8	1	2	36	4	0

Table 488: Cost Data Collection Example - Mid-Rise Mixed Use CPC Appendix A Base Case (Gas and HPWH Plant)

Baseline	Pipe Diameter	Total Piping Length (ft) or Quantity	Piping Material Cost (\$) Per (ft)	Cost of All Appurtenances \$	Labor Hrs	Total Material Cost \$	Labor Total at \$95/h	Total \$
DHW Distribution Using Appendix A	4"	53	\$69.95	\$-	14	\$4,684	\$2,307	\$6,990
	3"	91	\$41.80	\$-	18	\$5,280	\$3,186	\$8,467
	2.5"	73	\$28.43	\$-	14	\$3,180	\$2,434	\$5,614
	2"	85	\$16.92	\$-	10	\$2,677	\$2,189	\$4,866
	1.5"	939	\$14.67	\$1,100	95	\$27,786	\$21,936	\$49,723
	1.25"	0	\$9.69	\$-	0	\$-	\$-	\$-
	1"	338	\$7.29	\$-	34	\$5,903	\$6,669	\$12,572
	0.75"	744	\$5.29	\$1,430	65	\$12,731	\$13,541	\$26,272
	Totals	2,323	NA	\$2,530	250	\$62,242	\$52,262	\$114,504
Baseline: DCW Distribution Using Appendix A	4"	19	\$69.95	\$9,500	35.5	\$10,829	\$3,373	\$14,202
	3"	107	\$41.80	\$130	24	\$4,603	\$2,280	\$6,883
	2.5"	66	\$28.43	\$45	13.5	\$1,921	\$1,283	\$3,204
	2"	115	\$16.92	\$75	15.5	\$2,021	\$1,473	\$3,493
	1.5"	81	\$14.67	\$175	12	\$1,363	\$1,140	\$2,503
	1.25"	720	\$9.69	\$1,450	90	\$8,427	\$8,550	\$16,977
	1"	220	\$7.29	\$175	27	\$1,779	\$2,565	\$4,344
	0.75"	200	\$5.29	\$275	11	\$1,333	\$1,045	\$2,378
	Totals	1,528	NA	\$11,825	228.5	\$32,276	\$21,708	\$53,983
Gas Heating Plant Using Appendix A	6"	0	\$142.85	\$-	0	\$-	\$-	\$-
	5"	0	\$-	\$-	0	\$-	\$-	\$-
	4"	68	\$69.95	\$38,680	29	\$44,690	\$4,008	\$48,697
	3"	48	\$41.80	\$15,750	30	\$18,535	\$3,629	\$22,164
	2.5"	0	\$28.43	\$-	0	\$-	\$-	\$-
	2"	12	\$16.92	\$1,250	7	\$1,628	\$840	\$2,468
	1.5"	0	\$14.67	\$-	0	\$-	\$-	\$-
	1"	0	\$7.29	\$725	0.5	\$725	\$48	\$773
	0.75"	0	\$5.29	\$75	1	\$75	\$95	\$170
	Totals	128	NA	\$56,480	67.5	\$65,653	\$8,619	\$74,272

Baseline	Pipe Diameter	Total Piping Length (ft) or Quantity	Piping Material Cost (\$) Per (ft)	Cost of All Appurtenances \$	Labor Hrs	Total Material Cost \$	Labor Total at \$95/h	Total \$
HPWH Plant Using Appendix A	6"	0	\$142.85	\$-	0	\$-	\$-	\$-
	5"	0	\$-	\$-	0	\$-	\$-	\$-
	4"	68	\$69.95	\$23,535	26.5	\$29,545	\$3,770	\$33,315
	3"	12	\$41.80	\$1,235	3	\$1,931	\$480	\$2,411
	2.5"	0	\$28.43	\$-	0	\$-	\$-	\$-
	2"	12	\$16.92	\$1,525	7.5	\$1,903	\$887	\$2,790
	1.5"	12	\$14.67	\$80	2	\$421	\$355	\$776
	1"	24	\$7.29	\$2,430	17.5	\$2,849	\$1,907	\$4,756
	0.75"	0	\$5.29	\$50	1	\$50	\$95	\$145
	Totals	128	NA	\$28,855	57.5	\$36,699	\$7,494	\$44,193
Gas Heating Plant Using Appendix A	Baseline Totals	3,979	NA	\$70,835	546	\$160,170	\$82,589	\$242,759
HPWH Plant Using Appendix A	Baseline Totals	3,979	NA	\$43,210.0	536	\$131,216	\$81,464	\$212,680

Table 489: Cost Data Collection Example Mid-Rise Mixed Use Enhanced Pipe Insulation Base Case (Gas and HPWH Plant)

Baseline	Pipe Diameter	Total Piping Length (ft)	Number of Pipe Supports	Pipe Support Insulation Cost	Material Cost Per (ft)	Labor Hrs	Labor Total (\$)	Total Material Cost (\$)	Total (\$)
Distribution Supply and Return	4"	53	7	\$-	\$33.50	0.7	\$70	\$1,776	\$1,846
	3"	91	11	\$-	\$29.50	1.1	\$110	\$2,685	\$2,795
	2.5"	73	9	\$-	\$27.50	0.9	\$90	\$2,008	\$2,098
	2"	85	11	\$-	\$26.50	1.1	\$110	\$2,253	\$2,363
	1.5"	939	117	\$-	\$25.00	11.7	\$1,170	\$23,475	\$24,645
	1.25"	0	0	\$-	\$23.50	0	\$-	\$-	\$-
	1"	338	42	\$-	\$18.50	4.2	\$420	\$6,253	\$6,673
	0.75"	744	93	\$-	\$18.00	9.3	\$930	\$13,392	\$14,322
	0.5"	0	0	\$-	\$17.00	0	\$-	\$-	\$-
	Totals	2323	290	\$-	NA	29	\$2,900	\$51,840	\$54,740

Baseline	Pipe Diameter	Total Piping Length (ft)	Number of Pipe Supports	Pipe Support Insulation Cost	Material Cost Per (ft)	Labor Hrs	Labor Total (\$)	Total Material Cost (\$)	Total (\$)
Gas Water Heater Plant	6"	0	NA	NA	\$42.75	0	\$-	\$-	\$-
	5"	0	NA	NA	\$38.00	0	\$-	\$-	\$-
	4"	68	NA	NA	\$33.50	6.8	\$680	\$2,278	\$2,958
	3"	48	NA	NA	\$29.50	4.8	\$480	\$1,416	\$1,896
	2.5"	0	NA	NA	\$27.50	0	\$-	\$-	\$-
	2"	12	NA	NA	\$26.50	1.2	\$120	\$318	\$438
	1.5"	0	NA	NA	\$25.00	0	\$-	\$-	\$-
	1.25"	0	NA	NA	\$23.50	0	\$-	\$-	\$-
	1"	0	NA	NA	\$18.50	0	\$-	\$-	\$-
	0.75"	0	NA	NA	\$18.00	0	\$-	\$-	\$-
	0.5"	0	NA	NA	\$17.00	0	\$-	\$-	\$-
	Totals	128	NA	NA	NA	12.8	\$1,280	\$4,012	\$5,292
Heat Pump Water Heater Plant	6"	0	NA	NA	\$42.75	0	\$-	\$-	\$-
	5"	0	NA	NA	\$38.00	0	\$-	\$-	\$-
	4"	68	NA	NA	\$33.50	6.8	\$680	\$2,278	\$2,958
	3"	12	NA	NA	\$29.50	1.2	\$120	\$354	\$474
	2.5"	0	NA	NA	\$27.50	0	\$-	\$-	\$-
	2"	12	NA	NA	\$26.50	1.2	\$120	\$318	\$438
	1.5"	12	NA	NA	\$25.00	1.2	\$120	\$300	\$420
	1.25"	0	NA	NA	\$23.50	0	\$-	\$-	\$-
	1"	24	NA	NA	\$18.50	2.4	\$240	\$444	\$684
	0.75"	0	NA	NA	\$18.00	0	\$-	\$-	\$-
	0.5"	0	NA	NA	\$17.00	0	\$-	\$-	\$-
	Totals	128	NA	NA	NA	12.8	\$1,280	\$3,694	\$4,974
Gas Water Heater Plant	Baseline Totals	2451	290	0	NA	41.8	\$4,180	\$55,852	\$60,032
Heat Pump Water Heater Plant	Baseline Totals	2451	290	0	NA	41.8	\$4,180	\$55,534	\$59,714

a. Note: Costs provided by the mechanical contractor and their subcontractor. The "Material Cost per (ft)" shown above represent the total material AND labor costs by the subcontractor for the purchase and installation of the insulation including their own adders. The "Labor Total" only represents the adders of the mechanical contractor that would be incurred for administrative efforts to subcontract the work.

Table 490: Cost Data Collection Example - Mid-Rise Mixed Use Enhanced Pipe Insulation Proposed Case (Gas & HPWH Plant)

Proposed Case	Pipe Diameter	Total Piping Length (ft)	Number of Pipe Supports	Pipe Support Insulation Cost	Material Cost Per (ft)	Total Material Cost (\$)	Labor Hrs	Labor Total (\$)	Total (\$)
Distribution Supply and Return	4"	53	7	\$27.10	\$37.00	\$2,151	0.7	\$70	\$2,221
	3"	91	11	\$24.74	\$32.50	\$3,230	1.1	\$110	\$3,340
	2.5"	73	9	\$23.38	\$30.50	\$2,437	0.9	\$90	\$2,527
	2"	85	11	\$18.25	\$29.50	\$2,708	1.1	\$110	\$2,818
	1.5"	939	117	\$8.55	\$27.50	\$26,823	11.7	\$1,170	\$27,993
	1.25"	0	0	\$7.43	\$26.00	\$-	0	\$-	\$-
	1"	338	42	\$5.50	\$20.50	\$7,160	4.2	\$420	\$7,580
	0.75"	744	93	\$4.00	\$20.00	\$15,252	9.3	\$930	\$16,182
	0.5"	0	0	\$3.00	\$19.00	\$-	0	\$-	\$-
	Totals	2323	290	\$122	NA	59760.36	\$29	\$2,900	\$62,660
Gas Water Heater Plant	6"	0	NA	NA	\$47.00	\$-	0	\$-	\$-
	5"	0	NA	NA	\$42.00	\$-	0	\$-	\$-
	4"	68	NA	NA	\$37.00	\$2,516	6.8	\$680	\$3,196
	3"	48	NA	NA	\$32.50	\$1,560	4.8	\$480	\$2,040
	2.5"	0	NA	NA	\$30.50	\$-	0	\$-	\$-
	2"	12	NA	NA	\$29.50	\$354	1.2	\$120	\$474
	1.5"	0	NA	NA	\$27.50	\$-	0	\$-	\$-
	1.25"	0	NA	NA	\$26.00	\$-	0	\$-	\$-
	1"	0	NA	NA	\$20.50	\$-	0	\$-	\$-
	0.75"	0	NA	NA	\$20.00	\$-	0	\$-	\$-
	0.5"	0	NA	NA	\$19.00	\$-	0	\$-	\$-
	Totals	128	NA	NA	NA	4430	\$13	\$1,280	\$5,710

Proposed Case	Pipe Diameter	Total Piping Length (ft)	Number of Pipe Supports	Pipe Support Insulation Cost	Material Cost Per (ft)	Total Material Cost (\$)	Labor Hrs	Labor Total (\$)	Total (\$)
Heat Pump Water Heater Plant	6"	0	NA	NA	\$47.00	\$-	0	\$-	\$-
	5"	0	NA	NA	\$42.00	\$-	0	\$-	\$-
	4"	68	NA	NA	\$37.00	\$2,516	6.8	\$680	\$3,196
	3"	12	NA	NA	\$32.50	\$390	1.2	\$120	\$510
	2.5"	0	NA	NA	\$30.50	\$-	0	\$-	\$-
	2"	12	NA	NA	\$29.50	\$354	1.2	\$120	\$474
	1.5"	12	NA	NA	\$27.50	\$330	1.2	\$120	\$450
	1.25"	0	NA	NA	\$26.00	\$-	0	\$-	\$-
	1"	24	NA	NA	\$20.50	\$492	2.4	\$240	\$732
	0.75"	0	NA	NA	\$20.00	\$-	0	\$-	\$-
	0.5"	0	NA	NA	\$19.00	\$-	0	\$-	\$-
	Totals	128	NA	NA	NA	\$4,082	\$13	\$1,280	\$5,362
Gas Water Heater Plant	Proposed Totals	2,451	290	121.95	NA	\$64,190.36	\$42	\$4,180	\$68,370
Heat Pump Water Heater Plant	Proposed Totals	2,451	290	121.95	NA	\$63,842.36	\$42	\$4,180	\$68,022

- a. Note: Costs provided by the mechanical contractor and their subcontractor. The "Material Cost per (ft)" shown above represent the total material AND labor costs by the subcontractor for the purchase and installation of the insulation including their own adders. The "Labor Total" only represents the adders of the mechanical contractor that would be incurred for administrative efforts to subcontract the work.

Appendix J: Prototypes and Basis of Design CPC Appendix M Pipe Sizing Methodology

The Statewide CASE Team developed DHW systems plumbing designs for the different prototype multifamily buildings: low-rise garden style, low-rise loaded corridor, mid-rise mixed use, and high-rise mixed use by following CPC Appendix M sizing methodology. Figure 31 through Figure 34 and Table 491 through Table 494 represent the specifications of these designs.

The resulting prototype designs were then used to model energy use for the proposed Master Mixing Valve (proposed case) and CPC Appendix M Pipe Sizing (proposed case) measures. The Energy Impact Analysis Methodology for these measures can be reviewed in Appendix H.

Additionally, the prototype designs were used to collect costs for the proposed CPC Appendix M pipe Sizing measure. An example of the raw cost data collected from the contractor can be found in Table 497.

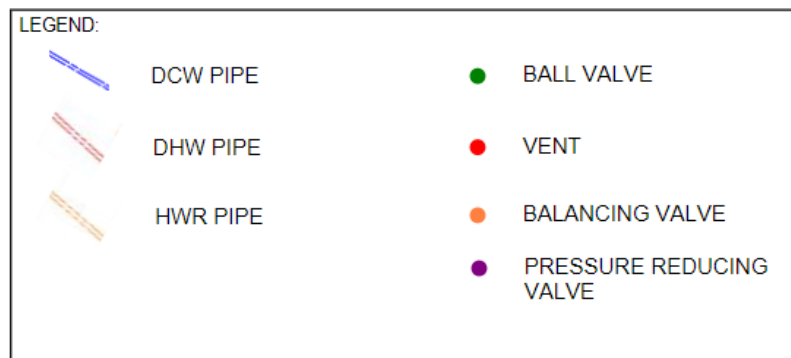
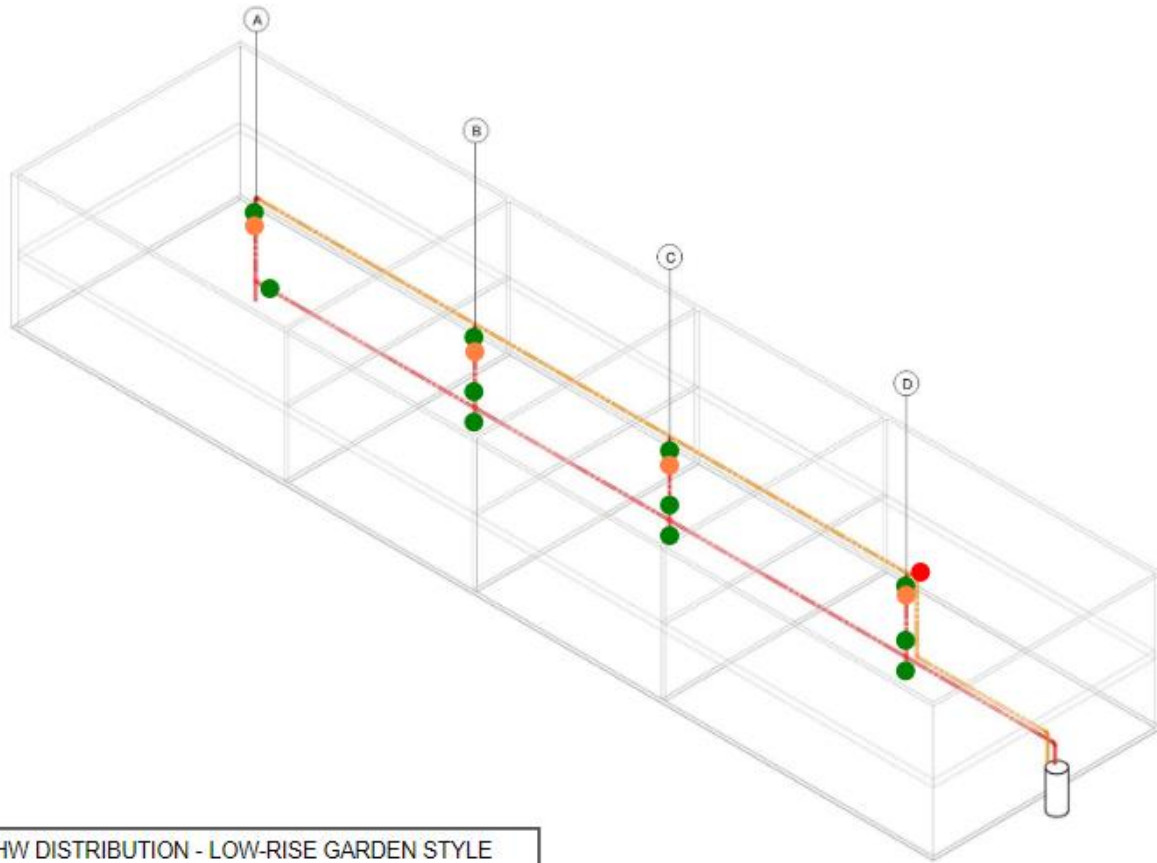

Figure 30: Pipe and appurtenance type key.



DHW DISTRIBUTION - LOW-RISE GARDEN STYLE

Figure 31: Low-rise garden style domestic hot water piping schematic with appurtenance locations.

Table 491: Low-Rise Garden Style Domestic Hot Water Pipe Length by Diameter
CPC Appendix M Specifications

Diameter (inches)	Primary Main	Horizontal	Recirc	Riser A	Riser B	Riser C	Riser D	Total (ft)
3	0	0	0	0	0	0	0	0
2.5	0	0	0	0	0	0	0	0
2	0	0	0	0	0	0	0	0
1.5	52	0	0	0	0	0	0	52
1	55	0	0	0	0	0	0	55
0.75	0	0	114	13.5	13.5	13.5	13.5	168

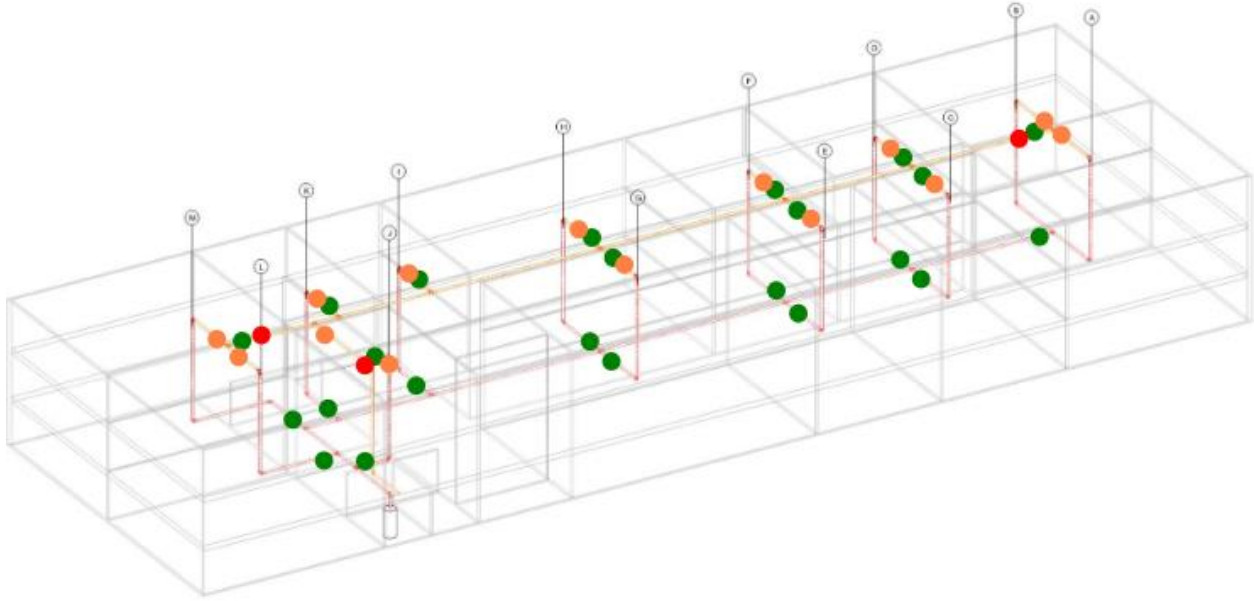

DHW DISTRIBUTION - LOW-RISE LOADED CORRIDOR

Figure 32: Low-rise loaded corridor domestic hot water piping schematic with apurtenance locations.

Table 492: Low-Rise Loaded Corridor Domestic Hot Water Pipe Length by Diameter CPC Appendix M Specifications

Diameter (inches)	Primary Main	Horizontal	Recirc	Riser A-H	Riser I-K	Riser L,M	Total (ft)
3	0	0	0	0	0	0	0
2.5	0	0	0	0	0	0	0
2	80	0	0	0	0	0	80
1.5	85	22	0	0	0	0	107
1	0	130	40	9	9	9	287
0.75	0	0	287	13.5	9	13.5	449

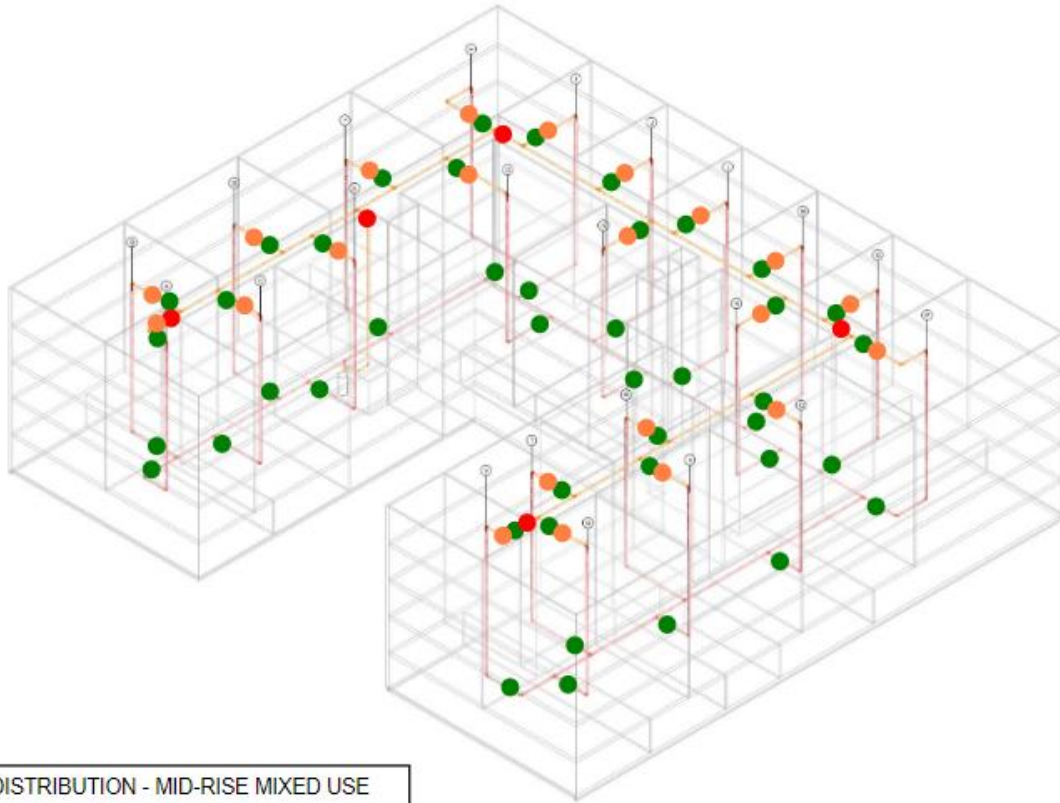
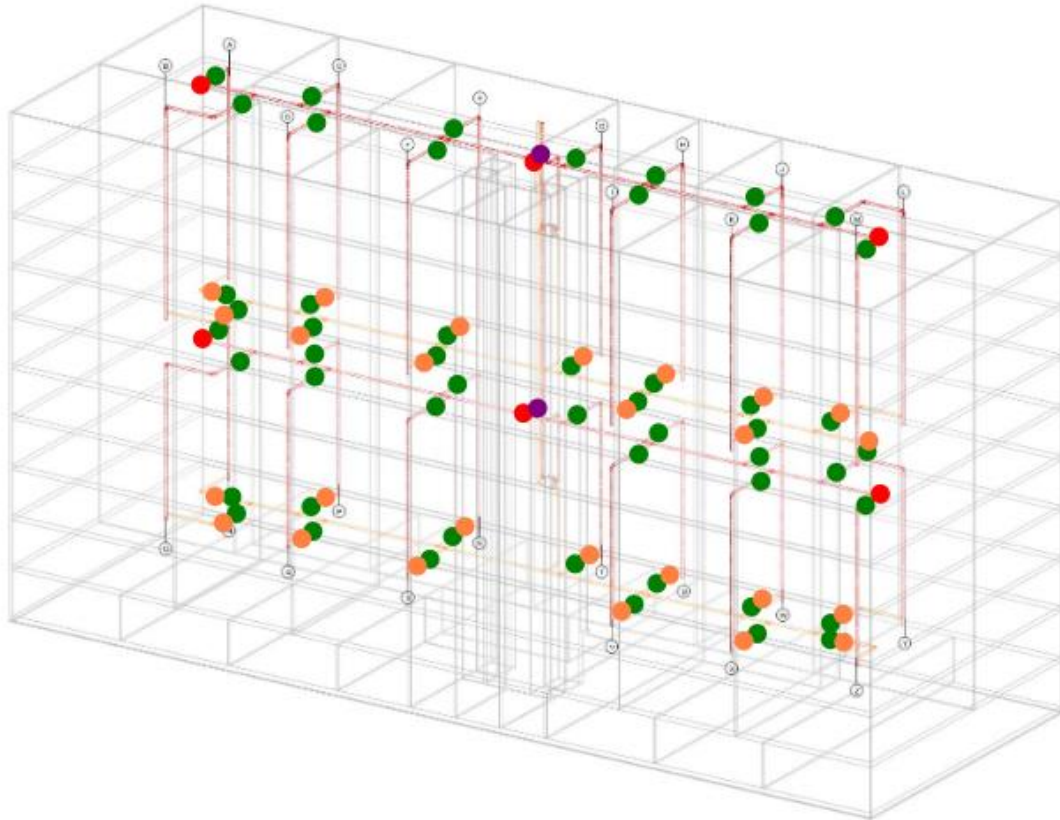

Figure 33: Mid-rise domestic hot water piping schematic with appurtenance locations.

Table 493: Mid-Rise Domestic Hot Water Pipe Length by Diameter CPC Appendix M Specifications

Diameter (inches)	Primary Main	Horizontal	Recirc	Riser A-G	Riser H,P	Riser I-O	Riser Q-V	Total (ft)
4	0	0	0	0	0	0	0	0
3	0	0	0	0	0	0	0	0
2.5	121	0	0	0	0	0	0	121
2	66	0	0	0	0	0	0	66
1.5	115	41	48	0	25	0	0	254
1	0	300	118	35	20	35	35	1,158
0.75	0	0	524	10	0	10	10	724



DHW DISTRIBUTION - HIGH RISE MIXED USE

Figure 34: High-rise domestic hot water piping schematic with appurtenance locations.

Table 494: High-Rise Domestic Hot Water Pipe Length by Diameter CPC Appendix M Specifications

Diameter (inches)	Primary Main	Horizontal	Recirc	Main Riser	Recirc Riser	Riser A-M	Riser N-Z	Total (ft)
4	0	0	0	0	0	0	0	0
3	0	0	0	5	0	0	0	5
2.5	4	0	0	62	63	0	0	129
2	80	0	0	0	0	0	0	80
1.5	148	0	0	0	0	0	0	148
1	0	392	53	0	0	30	20	1,095
0.75	0	0	628	0	0	15	15	1,018
0.5	0	0	0	0	0	0	0	0

Table 495: Gas Heating Plant Appurtenance Counts and Straight Pipe Length CPC Appendix M

Prototype	Pipe Diameter (in)	Master Mixing Valve	Ball Valve	Balancing Valve	T & P Relief Valve	Check Valve	Wye/Strainer	Hose Bib	90	Tee	Vent	Straight Pipe (ft)	Dielectric Union	Circ. Pump
Low-Rise Garden Style	0.5	0	0	0	0	0	0	0	0	0	0	0	0	0
	0.75	0	5	2	0	4	0	1	0	2	1	12	0	1
	1	0.8	0	0	2	0	0	0	0	0	0	0	0	0
	1.5	0	3	0	0	1	2	2	15	7	0	36	1	1
	2	0	6	0	0	1	1	0	15	1	2	44	8	0
	2.5	0	0	0	0	0	0	0	0	0	0	0	0	0
	3	0	0	0	0	0	0	0	0	0	0	0	0	0
Low-Rise Loaded Corridor	0.5	0	0	0	0	0	0	0	0	0	0	0	0	0
	0.75	0	6	0	0	1	0	0	0	1	0	0	0	0
	1	0	0	2	3	3	0	1	0	1	1	12	0	1
	1.5	0.8	0	0	0	0	0	0	0	0	0	0	0	0
	2	0	13	0	0	3	5	4	37	3	2	86	12	2
	2.5	0	0	0	0	0	0	0	0	0	0	0	0	0
	3	0	0	0	0	0	0	0	4	10	0	12	0	0
Mid-Rise Mixed Use	0.5	0	0	0	0	0	0	0	0	0	0	0	0	0
	0.75	0	5	0	0	0	0	0	0	0	0	0	0	0
	1	0	0	0	4	0	0	0	0	0	0	0	0	0
	1.5	0	0	0	0	0	0	0	0	0	0	0	0	0
	2	0	2	2	0	4	0	1	0	2	1	12	0	1
	2.5	0	0	0	0	0	0	0	0	0	0	0	0	0
	3	1.6	17	0	0	4	7	6	48	5	2	104	15	3
	4	0	0	0	0	0	0	0	4	13	0	0	0	0
High-Rise Mixed Use	0.5	0	0	0	0	0	0	0	0	0	0	0	0	0
	0.75	0	7	0	0	0	0	0	0	0	0	0	0	0
	1	0	4	4	6	8	0	2	0	2	2	24	0	2
	1.5	0	0	0	0	0	0	0	0	0	0	0	0	0
	2	3.2	2	0	0	0	0	0	6	0	0	24	2	0
	2.5	0	0	0	0	0	0	0	0	0	0	0	0	0
	3	0	10	0	0	3	6	6	34	4	0	76	4	3
	4	0	0	0	0	0	0	0	4	19	0	12	0	0
	5	0	12	0	0	1	2	0	26	1	2	48	18	0
	6	0	0	0	0	0	0	0	0	0	0	0	0	0

Table 496: HPWH Plant Appurtenance Counts and Straight Pipe Length CPC Appendix M

Prototype	Pipe Diameter (in)	Master Mixing Valve	Ball Valve	Balancing Valve	T & P Relief Valve	Check Valve	Wye/Strainer	Hose Bib	90	Tee	Vent	Straight Pipe (ft)	Dielectric Union	Circ. Pump
Low-Rise Garden Style	0.5	0	2	0	0	1	1	2	12	2	0	24	0	0
	0.75	0	5	2	0	4	0	1	0	2	1	12	0	1
	1	0.8	0	0	2	0	0	0	0	0	0	0	0	0
	1.5	0	1	0	0	0	0	0	3	0	0	12	1	0
	2	0	6	0	0	1	1	0	21	2	2	56	6	0
	2.5	0	0	0	0	0	0	0	0	0	0	0	0	0
	3	0	0	0	0	0	0	0	0	0	0	0	0	0
Low-Rise Loaded Corridor	0.5	0	10	0	0	5	5	10	40	8	0	48	0	0
	0.75	0	3	0	0	1	0	0	4	1	0	12	0	0
	1	0	2	2	2	3	0	1	0	1	1	12	0	1
	1.5	0.8	0	0	0	0	0	0	0	0	0	0	0	0
	2	0	7	0	0	1	1	0	24	2	2	68	7	0
	2.5	0	0	0	0	0	0	0	0	0	0	0	0	0
	3	0	0	0	0	0	0	0	0	0	0	0	0	0
Mid-Rise Mixed Use	0.5	0	0	0	0	0	0	0	0	0	0	0	0	0
	0.75	0	4	0	0	0	0	0	0	0	0	0	0	0
	1	0	8	0	3	2	2	8	16	4	0	24	0	2
	1.5	0	0	0	0	0	0	0	4	0	0	12	0	0
	2	0	2	2	0	4	0	1	0	2	1	12	0	1
	2.5	0	0	0	0	0	0	0	0	0	0	0	0	0
	3	1.6	9	0	0	1	1	0	30	2	3	80	9	0
	4	0	0	0	0	0	0	0	0	0	0	0	0	0
High-Rise Mixed Use	0.5	0	0	0	0	0	0	0	0	0	0	0	0	0
	0.75	0	5	0	0	0	0	0	0	0	0	0	0	0
	1	0	12	4	4	10	2	10	16	6	2	48	0	4
	1.5	0	0	0	0	0	0	0	4	0	0	12	0	0
	2	3.2	2	0	0	0	0	0	6	0	0	24	2	0
	2.5	0	0	0	0	0	0	0	0	0	0	0	0	0
	3	0	8	0	0	0	0	0	22	2	2	64	8	0
	4	0	0	0	0	0	0	0	0	0	0	0	0	0
	5	0	4	0	0	1	2	0	20	1	2	36	4	0
	6	0	0	0	0	0	0	0	0	0	0	0	0	0

Table 497: Cost Data Collection Example Mid-Rise Mixed Use (Gas and HPWH Plant)

Case	Pipe Diameter	Total Piping Length (ft)	Piping Material Cost (\$) Per (ft)	Cost of All Appurtenances \$	Labor Hrs	Total Material Cost \$	Labor Total at \$95/h	Total \$
Proposed: DHW Distribution Using Appendix M	4"	0	\$69.95	\$0	\$0.00	\$0	\$0	\$0
	3"	0	\$41.80	\$0	\$0.00	\$0	\$0	\$0
	2.5"	121	\$28.43	\$0	\$22.00	\$5,270	\$3,920	\$9,190
	2"	66	\$16.92	\$0	\$8.00	\$2,079	\$1,722	\$3,801
	1.5"	254	\$14.67	\$100	\$26.00	\$7,319	\$5,963	\$13,281
	1.25"	0	\$9.69	\$0	\$0.00	\$0	\$0	\$0
	1"	1,158	\$7.29	\$400	\$119.00	\$20,624	\$23,088	\$43,712
	0.75"	724	\$5.29	\$1,450	\$68.00	\$12,448	\$13,628	\$26,075
	Totals	2,323	\$194.04	\$1,950	243	\$0	\$48,320	\$96,059
Proposed: DCW Distribution Using Appendix M	4"	0	\$69.95	\$-	0	\$-	\$-	\$-
	3"	0	\$41.80	\$-	0	\$-	\$-	\$-
	2.5"	0	\$28.43	\$-	0	\$-	\$-	\$-
	2"	0	\$16.92	\$-	0	\$-	\$-	\$-
	1.5"	68	\$14.67	\$4,100	37.5	\$5,098	\$3,563	\$8,660
	1.25"	161	\$9.69	\$100	17	\$1,660	\$1,615	\$3,275
	1"	139	\$7.29	\$100	13	\$1,113	\$1,235	\$2,348
	0.75"	1,160	\$5.29	\$1,000	107	\$7,136	\$10,165	\$17,301
	Totals	1,528	\$194.04	\$5,300	174.5	\$15,007	\$16,578	\$31,585
Baseline: Gas Heating Plant Using Appendix M	6"	0	\$142.85	\$-	0	\$-	\$-	\$-
	5"	0	\$-	\$-	0	\$-	\$-	\$-
	4"	0	\$69.95	\$3,150	3	\$3,150	\$285	\$3,435
	3"	104	\$41.80	\$28,250	37.5	\$34,285	\$5,250	\$39,535
	2.5"	0	\$28.43	\$-	0	\$-	\$-	\$-
	2"	12	\$16.92	\$1,490	7.5	\$1,868	\$887	\$2,755
	1.5"	0	\$14.67	\$-	0	\$-	\$-	\$-
	1"	0	\$7.29	\$725	1	\$725	\$95	\$820
	0.75"	0	\$5.29	\$75	1	\$75	\$95	\$170
Totals	116	\$327.20	\$33,690	50	\$40,103	\$6,612	\$46,715	

Case	Pipe Diameter	Total Piping Length (ft)	Piping Material Cost (\$) Per (ft)	Cost of All Appurtenances \$	Labor Hrs	Total Material Cost \$	Labor Total at \$95/h	Total \$
Baseline: HPWH Plant Using Appendix M	6"	0	\$142.85	\$17,212	0	\$22,417	\$-	\$-
	5"	0	\$-	N/A*	0	N/A*	\$-	\$-
	4"	0	\$69.95	N/A*	0	N/A*	\$-	\$-
	3"	80	\$41.80	N/A	16	N/A	\$1,520	\$1,520
	2.5"	0	\$28.43	N/A	0	N/A	\$-	\$-
	2"	12	\$16.92	N/A	7.5	N/A	\$713	\$713
	1.5"	12	\$14.67	N/A	2	N/A	\$190	\$190
	1"	24	\$7.29	N/A	17	N/A	\$1,615	\$1,615
	0.75"	0	\$5.29	N/A	1	N/A	\$95	\$95
	Totals	128	\$327.20	\$17,212	43.5	22417	\$4,133	\$4,133
Gas Heating Plant Using Appendix M	Baseline Totals	3,967	\$715.28	\$40,940	467.5	55110	\$71,510	\$174,359
HPWH Plant Using Appendix M	Baseline Totals	3,979	\$715.28	\$24,462	461	37424	\$69,030	\$131,777

*Contractor did not have time to provide cost. Total value is available and was determined based on cost difference between Gas Appendix A to Appendix M.

Appendix K: Central HPWH Clean-up Basis of Design, Modeling and Cost Analysis Details

This appendix describes the basis of design for the base central DHW HPWH system and the proposed central HPWH system for the four prototypes buildings.

- The Low-Rise Garden Style is a two-story, 8-unit building with two one-bedroom and two two-bedroom dwelling units. The total conditioned floor area of the building is 7,320 square feet.
- The Low-Rise Loaded Corridor is a three-story, 36-unit building with dwelling unit entry off an interior corridor, common laundry, gym, and business center. The prototype has 6 studio, 12 one-bedroom, 12 two-bedroom, and 6 three-bedroom dwelling units. The total conditioned floor area of the building is 39,372 square feet.
- The Mid-Rise Mixed-Use is a five-story, 88-unit building with one story of retail and common spaces under four stories of residential space. The prototype has 8 studios, 40 one-bedroom, 32 two-bedroom, and 8 three-bedroom dwelling units. The total conditioned floor area of the building is 113,700 square feet.
- The High-Rise Mixed-Use is a 10-story, 117-unit building with one story of retail and common space under nine stories of residential space. The prototype has 18 studios, 54 one-bedroom, and 45 two-bedroom dwelling units. The total conditioned floor area of the building is 125,400 square feet.

Sizing Criteria

The basis of design uses the following assumptions:

1. On average, the studio units have 1 occupant, the one-bedroom units have 1.5 occupants, the two-bedroom units have 2.5 occupants, and the three-bedroom units have 3.5 occupants.
2. The average maximum hot water demand is 22 gallons per person per day delivered at 120°F at the fixtures. This hot water demand assumption is based on practical experience and is between the low and medium guidelines in the ASHRAE HVAC Applications Handbook, Chapter 50 Service Water Heating (Table 7 – Hot Water Demand and Use Guidelines for Apartment Buildings 2019).
3. The recirculation loop heat loss is assumed as 100 W/Apartment.
4. The design air temperature for the HPWH is assumed to be 30°F.
5. The Aqustat Fraction of the HPWH is assumed to be 30 percent.
6. The design cold water temperature is assumed as 60°F.

7. The HPWH compressor is assumed to run 16 hours per day.

Standard Design Central HPWH System Sizing and Equipment Selection

The standard design is a Single-pass primary with Electric Resistance Water Heater for Temperature Maintenance System for all four prototypes, which is shown in Figure 35.

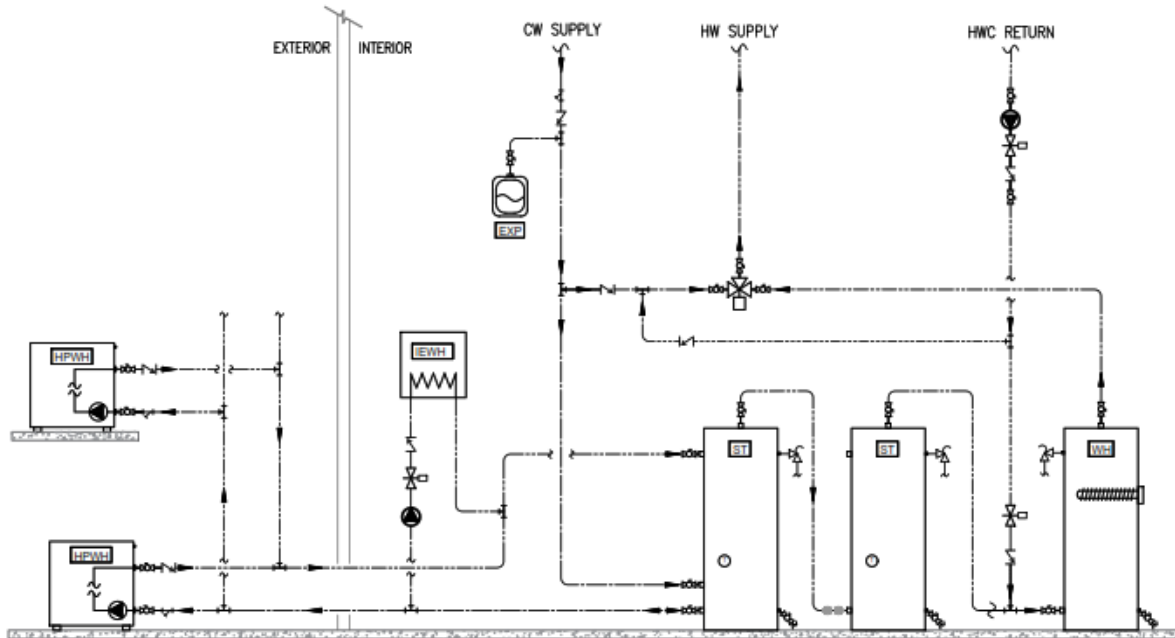

CONFIGURATION 1M

Figure 35: Single-pass primary with electric resistance water heater for temperature maintenance system.

The capacity requirements for the Single-pass primary with Electric Resistance Water Heater for Temperature Maintenance System are shown in Table 498.

Table 498: Capacity Requirements for Single-pass primary with Electric Resistance Water Heater

Building Type	Primary HPWH Recovery (BTU/h)	Storage (gallon)	Temp. Maint. Volume (gallon)	Temp. Maint. Recovery (kW)
LowRiseGarden	15,090	75	80	1
LoadedCorridor	66,500	289	80	6
MidRiseMixedUse	160,600	706	120	15
HighRiseMixedUse	201,400	867	120	21

The selected equipment for the Single-pass primary with Electric Resistance Water Heater for Temperature Maintenance System is shown in Table 499 through Table 502.

Table 499: Primary Heat Pump

Building Type	Qty.	Manufacturer	Model	Recovery Capacity (Btu/h)
LowRiseGarden	1	COLMAC	CxV-5	26019
LoadedCorridor	3	COLMAC	CxV-5	26019
MidRiseMixedUse	7	COLMAC	CxV-5	26019
HighRiseMixedUse	8	COLMAC	CxV-5	26019

Table 500: Primary Hot Water Storage Tank

Building Type	Qty.	Manufacturer	Model	Capacity (gallon)	Total Capacity (gallon)
LowRiseGarden	1	AO SMITH	TJV-120A	119	119
LoadedCorridor	1	AO SMITH	HDX30-300A	294	294
MidRiseMixedUse	2	NILES ST	JS36-090	360	720
HighRiseMixedUse	2	NILES ST	JS36-114	465	930

Table 501: Primary Electric Resistance Back-Up

Building Type	Qty.	Manufacturer	Model	Electrical Power Consumption (kVA)
LowRiseGarden	N/A	N/A	N/A	N/A
LoadedCorridor	N/A	N/A	N/A	N/A
MidRiseMixedUse	1	RHEEM	RTEX-36	150A
HighRiseMixedUse	1	RHEEM	RTEX-36	150A

Table 502: Temperature Maintenance Electric Resistance

Building Type	Qty.	Manufacturer	Model	Capacity (gallons)	Electrical Power Consumption (kW)
LowRiseGarden	1	RHEEM	ELD80-TB	80	12
LoadedCorridor	1	RHEEM	ELD120-TB	120	12
MidRiseMixedUse	1	NILES ST	JEV150-15KW	150	15
HighRiseMixedUse	2	NILES ST	JEV150-12KW	150	15

Proposed Design Central HPWH_SPST Sizing and Equipment Selection

The proposed HPWH_SPST has the same system configuration and capacity requirements as the standard design.

The selected equipment for the Single-pass Return to Primary system is shown in Table 503 through Table 506.

Table 503: Primary Heat Pump

Building Type	Qty.	Manufacturer	Model	Recovery Capacity (Btu/h)
LowRiseGarden	1	SanCO2	GS4	15,000
LoadedCorridor	5	SanCO2	GS4	15,000
MidRiseMixedUse	2	Mitsubishi	Heat2O	110,000
HighRiseMixedUse	2	Mitsubishi	Heat2O	110,000

Table 504: Primary Hot Water Storage Tank

Building Type	Qty.	Manufacturer	Model	Capacity (gallon)	Total Capacity (gallon)
LowRiseGarden	1	AO SMITH	TJV-120A	119	119
LoadedCorridor	1	AO SMITH	HDV30-300A	294	294
MidRiseMixedUse	2	NILES ST	JS36-090	360	720
HighRiseMixedUse	2	NILES ST	JS36-114	465	930

Table 505: Primary Electric Resistance Back-Up

Building Type	Qty.	Manufacturer	Model	Electrical Power Consumption (kVA)
LowRiseGarden	N/A	N/A	N/A	N/A
LoadedCorridor	N/A	N/A	N/A	N/A
MidRiseMixedUse	1	RHEEM	RTEX-36	36
HighRiseMixedUse	1	RHEEM	RTEX-36	36

Table 506: Temperature Maintenance Electric Resistance

Building Type	Qty.	Manufacturer	Model	Capacity (gallons)	Electrical Power Consumption (kW)
LowRiseGarden	1	RHEEM	ELD80-TB	80	12
LoadedCorridor	1	RHEEM	ELD120-TB	120	12
MidRiseMixedUse	1	NILES ST	JEV150-15KW	150	15
HighRiseMixedUse	2	NILES ST	JEV150-12KW	150	15

Proposed Design Central HPWH_MPRetP Sizing and Equipment Selection

Figure 36 shows the proposed design for Multi-pass Return to Primary system.

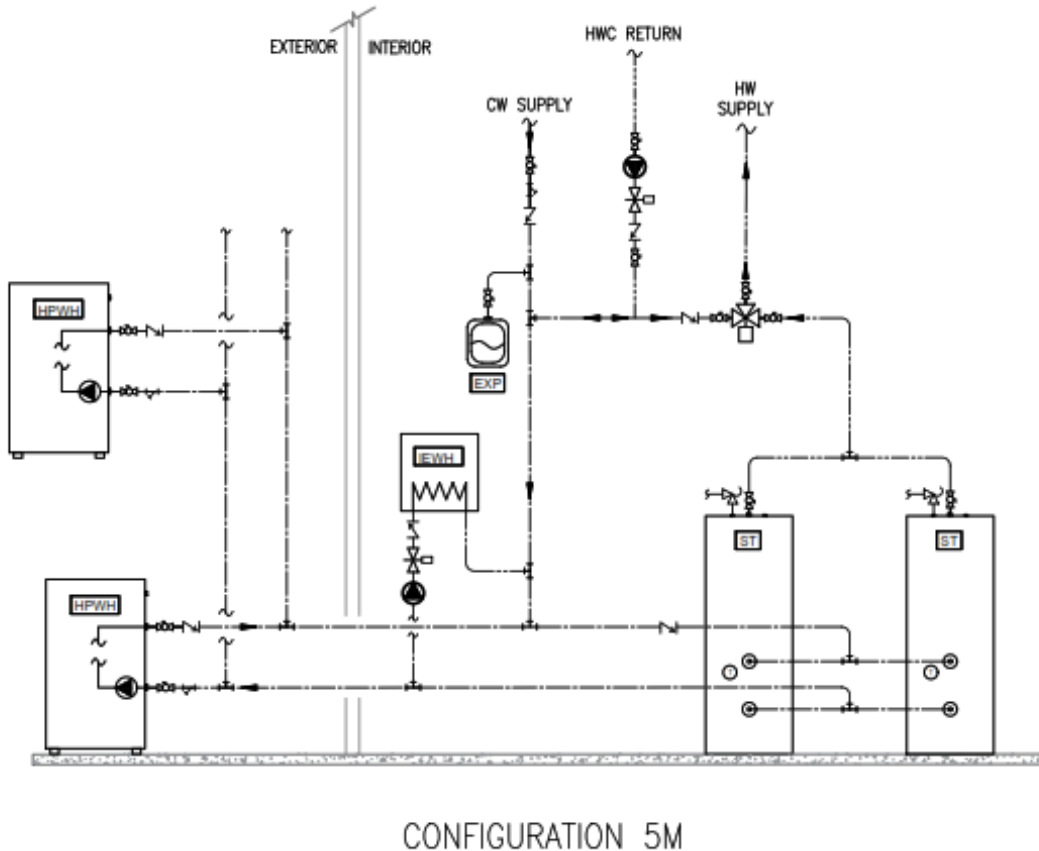

Figure 36: Multi-pass return to primary.

The capacity requirements for the Multi-pass Return to Primary system are shown in Table 507.

Table 507: Capacity Requirements for Multi-pass Return to Primary

Building Type	Primary HPWH Recovery (BTU/h)	Storage (gallon)
LowRiseGarden	31,075	113
LoadedCorridor	136,253	434
MidRiseMixedUse	219,120	1,059
HighRiseMixedUse	227,237	1,301

The selected equipment for the Multi-pass Return to Primary system is shown in Table 508 through Table 510.

Table 508: Primary Heat Pump

Building Type	Qty.	Manufacturer	Model	Recovery Capacity (Btu/h)
LowRiseGarden	2	Colmac	CxV-5	26019
LoadedCorridor	6	Colmac	CxV-5	26019
MidRiseMixedUse	3	Colmac	CxA-20	83452.2
HighRiseMixedUse	3	Colmac	CxA-20	83452.2

Table 509: Primary Hot Water Storage Tank

Building Type	Qty.	Manufacturer	Model	Capacity (gallon)	Total Capacity (gallon)
LowRiseGarden	1	AO SMITH	TJV-120A	119	119
LoadedCorridor	1	AO SMITH	HDV42-450A	432	432
MidRiseMixedUse	2	AO SMITH	HDV48-500A	500	1000
HighRiseMixedUse	3	AO SMITH	HDV36-425A	423	1269

Table 510: Primary Electric Resistance Back-Up

Building Type	Qty.	Manufacturer	Model	Electrical Power Consumption (kVA)
LowRiseGarden	1	RHEEM	RTEX-06	6
LoadedCorridor	1	RHEEM	RTEX-36	36
MidRiseMixedUse	2	RHEEM	RTEX-36	36
HighRiseMixedUse	3	RHEEM	RTEX-36	36

Proposed Design Central HPWH_SPwMPTM Sizing and Equipment Selection

The Single-pass Primary with Multi-pass in parallel for Temperature Maintenance System design can be seen in Figure 37. This design only applies to MidRiseMixedUse and HighRiseMixedUse.

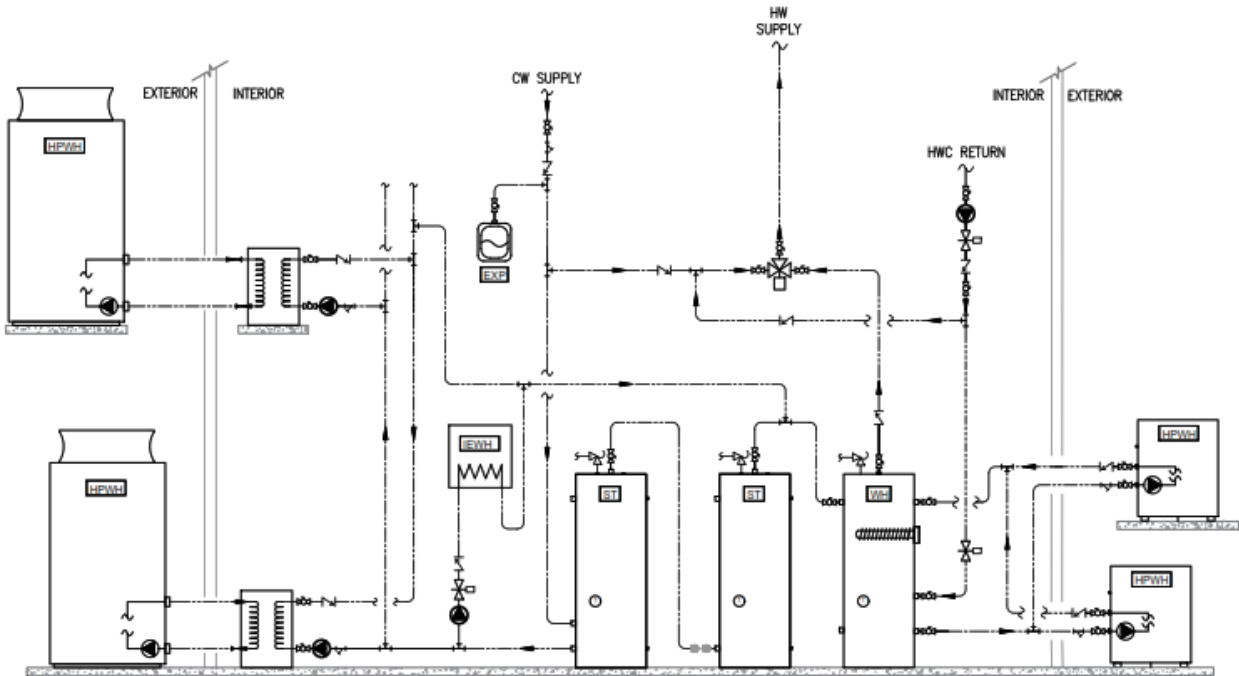

Figure 37: Single-pass primary with multi-pass in parallel for temperature maintenance system design.

The capacity requirements for the Single-pass Primary with Multi-pass in parallel for Temperature Maintenance System design are shown in Table 511.

Table 511: Capacity Requirements for Single-pass Primary with Multi-pass in parallel for Temperature Maintenance System design

Building Type	Primary HPWH Recovery (BTU/h)	Storage (gallon)	Temp. Maint. Volume (gallon)	Temp. Maint. Recovery (Btu/h)
LowRiseGarden	11,880	60	14	4,800
LoadedCorridor	54,200	268	61	21,500
MidRiseMixedUse	129,300	631	149	52,500
HighRiseMixedUse	161,450	787	198	69,900

The selected equipment for the Single-pass Return to Primary system is shown in Table 512 through Table 516.

Table 512: Primary Heat Pump

Building Type	Qty.	Manufacturer	Model	Recovery Capacity (Btu/h)
LowRiseGarden	N/A	N/A	N/A	N/A
LoadedCorridor	N/A	N/A	N/A	N/A
MidRiseMixedUse	1	Mitsubishi	Heat2O	110,000
HighRiseMixedUse	2	Mitsubishi	Heat2O	110,000

Table 513: Primary Hot Water Storage Tank

Building Type	Qty.	Manufacturer	Model	Capacity (gallon)	Total Capacity (gallon)
LowRiseGarden	N/A	N/A	N/A	N/A	N/A
LoadedCorridor	N/A	N/A	N/A	N/A	N/A
MidRiseMixedUse	2	NILES ST	JS36-102	415	830
HighRiseMixedUse	2	NILES ST	JS36-102	415	830

Table 514: Primary Electric Resistance Back-Up

Building Type	Qty.	Manufacturer	Model	Electrical Power Consumption (kVA)
LowRiseGarden	N/A	N/A	N/A	N/A
LoadedCorridor	N/A	N/A	N/A	N/A
MidRiseMixedUse	1	RHEEM	RTEX-36	36
HighRiseMixedUse	1	RHEEM	RTEX-36	36

Table 515: Temperature Maintenance HPWH

Building Type	Qty.	Manufacturer	Model	Capacity (gallons)	Electrical Power Consumption (kW)
LowRiseGarden	N/A	N/A	N/A	N/A	N/A
LoadedCorridor	N/A	N/A	N/A	N/A	N/A
MidRiseMixedUse	2	Colmac	CxV-5	26019	2
HighRiseMixedUse	4	Colmac	CxV-5	26019	4

Table 516: Temperature Maintenance Storage Tank

Building Type	Qty.	Manufacturer	Model	Capacity (gallons)	Electrical Power Consumption (kW)
LowRiseGarden	N/A	N/A	N/A	N/A	N/A
LoadedCorridor	N/A	N/A	N/A	N/A	N/A
MidRiseMixedUse	1	NILES ST	JS30-063	175	175
HighRiseMixedUse	2	AO SMITH	TJV-120A	119	238

Proposed Design Central HPWH_SPRetP Sizing and Equipment Selection

Figure 38 shows the proposed design for single-pass return to primary system.

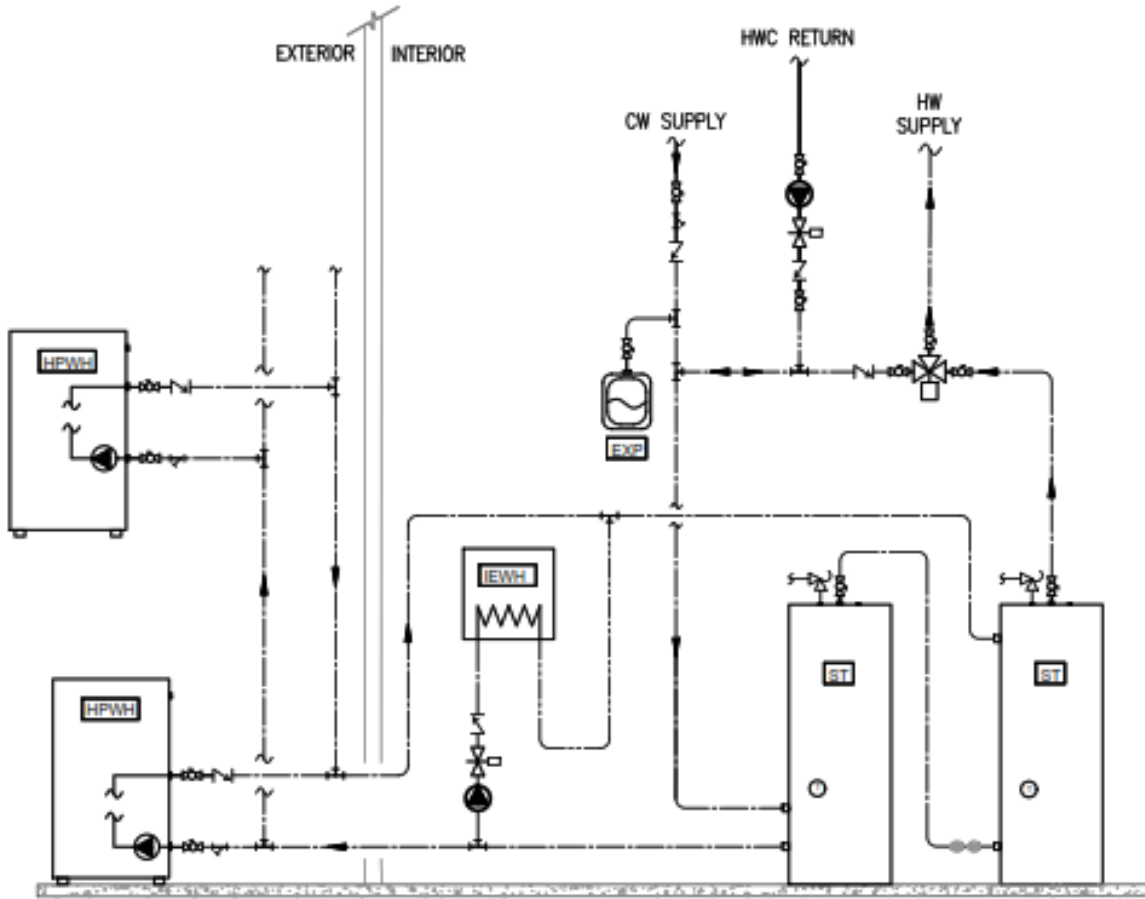

Figure 38: Single-pass return to primary.

The capacity requirements for the single-pass return to primary system are shown in Table 517.

Table 517: Capacity Requirements for Single-pass Return to Primary

Building Type	Primary HPWH Recovery (BTU/h)	Storage (gallon)*
LowRiseGarden	16,680	80
LoadedCorridor	75,670	370
MidRiseMixedUse	181,840	879
HighRiseMixedUse	231,350	1,097

The selected equipment for the single-pass return to primary system is shown in Table 518 through Table 520.

Table 518: Primary Heat Pump

Building Type	Qty.	Manufacturer	Model	Recovery Capacity (Btu/h)
LowRiseGarden	1	Colmac	CxV-5	26019
LoadedCorridor	1	Nyle	E360	105,750
MidRiseMixedUse	2	Nyle	E360	105,750
HighRiseMixedUse	3	Nyle	E360	105,750

Table 519: Primary Hot Water Storage Tank

Building Type	Qty.	Manufacturer	Model	Capacity (gallon)	Total Capacity (gallon)
LowRiseGarden	1	AO SMITH	TJV-120A	119	119
LoadedCorridor	1	AO SMITH	HDV36-400A	370	370
MidRiseMixedUse	2	AO SMITH	HDV42-450A	432	864
HighRiseMixedUse	2	AO SMITH	HDV48-500A	500	1000

Table 520: Primary Electric Resistance Back-Up

Building Type	Qty.	Manufacturer	Model	Electrical Power Consumption (kVA)
LowRiseGarden	1	RHEEM	RTEX-06	6
LoadedCorridor	1	RHEEM	RTEX-24	24
MidRiseMixedUse	1	RHEEM	RTEX-24	24
HighRiseMixedUse	1	RHEEM	RTEX-24	24

Incremental Cost Breakdown

The following tables show the incremental cost breakdown for the base case and the proposed cases for the Central HPWH measures for each prototype (Table 521 through Table 524). The Statewide CASE Team averaged the incremental cost breakdown across the two contractors. For the HPWH_SPST design in LowRiseGarden and LoadedCorridor, one of the contractors provided the total of combined cost for the primary system, including Primary Storage, Primary HPWH, and Temp. Maint. Electric Water Heater. Therefore, the Statewide CASE Team provided the average of the total of these equipment cost.

Table 521: Installed Cost Breakdown for Baseline and Proposed Central HPWH Designs for LowRiseGarden

Cost	HPWH Base	HPWH_SPST	HPWH_SPRetP	HPWH_MPRetP
Primary Storage	\$2,884	\$21,527 (including Primary HPWH and Temp. Maint. Electric Water Heater)	\$2,884	\$2,884
Primary HPWH	\$38,562	\$21,527 (including Primary Storage and Temp. Maint. Electric Water Heater)	\$38,562	\$77,123
Temp. Maint. Electric Water Heater	\$2,950	\$21,527 (including Primary HPWH and Primary Storage)	NA	NA
Electric Back-Up	\$0	\$0	\$185	\$185
Heat exchanger	\$0	\$0	\$0	\$0
Pumps	\$3,650	\$3,650	\$5,475	\$7,300
Expansion Tank	\$1,875	\$1,875	\$1,875	\$1,875
Electronic Mixing Valve	\$3,594	\$3,594	\$3,594	\$3,594
Piping	\$3,175	\$3,175	\$3,050	\$3,600
Miscellaneous supplies	\$150	\$150	\$150	\$225
Labor	\$8,365	\$8,365	\$8,335	\$10,533
Structural costs	\$2,500	\$2,500	\$2,500	\$3,500
Adders	\$0	\$0	\$0	\$0
Total	\$71,255	\$43,586	\$65,359	\$109,068
Total Per Dwelling Unit Cost	\$8,907	\$5,448	\$8,170	\$13,633
Incremental Cost per Dwelling Unit	NA	(\$2,858)	(\$137)	\$5,327

Table 522: Installed Cost Breakdown for Baseline and Proposed Central HPWH Designs for LoadedCorridor

Cost	HPWH Base	HPWH_SPST	HPWH_SPRetP	HPWH_MPRetP
Primary Storage	\$7,032	\$56,140 (including Primary HPWH and Temp. Maint. Electric Water Heater)	\$8,528	\$9,317
Primary HPWH	\$115,685	\$56,140 (including Primary Storage and Temp. Maint. Electric Water Heater)	\$79,437	\$231,369
Temp. Maint. Electric Water Heater	\$4,125	\$56,140 (including Primary HPWH and Primary Storage)	NA	NA
Electric Back-Up	\$0	\$0	\$529	\$869
Heat exchanger	\$0	\$0	\$0	\$0
Pumps	\$7,300	\$10,950	\$5,475	\$14,600
Expansion Tank	\$1,875	\$1,875	\$1,875	\$1,875
Electronic Mixing Valve	\$5,288	\$5,288	\$5,288	\$5,288
Piping	\$4,900	\$5,650	\$3,363	\$5,838
Miscellaneous supplies	\$200	\$200	\$150	\$300
Labor	\$13,113	\$16,713	\$8,985	\$18,405
Structural costs	\$4,500	\$4,500	\$2,500	\$7,500
Adders	\$0	\$0	\$0	\$0
Total	\$161,766	\$99,065	\$114,879	\$291,610
Total Per Dwelling Unit Cost	\$4,494	\$2,752	\$3,191	\$8,100
Incremental Cost per Dwelling Unit	NA	(\$1,742)	(\$1,302)	\$3,607

Table 523: Installed Cost Breakdown for Baseline and Proposed Central HPWH Designs for MidRiseMixedUse

Cost	HPWH Base	HPWH_SPST	HPWH_SPRetP	HPWH_MPRetP	HPWH_SPwMPTM
Primary Storage	\$29,114	\$29,114	\$18,634	\$24,377	\$30,071
Primary HPWH	\$269,931	\$54,910	\$158,875	\$256,676	\$27,455
Temp. Maint. Electric Water Heater	\$11,897	\$11,897	NA	NA	NA
Temp. Maint. HPWH	NA	NA	NA	NA	\$77,123
Temp. Maint. Storage	NA	NA	NA	NA	\$10,734
Electric Back-Up	\$869	\$869	\$529	\$1,738	\$869
Heat exchanger	\$0	\$6,000	\$0	\$0	\$3,000
Pumps	\$16,425	\$10,950	\$7,300	\$10,950	\$10,950
Expansion Tank	\$1,875	\$1,875	\$1,875	\$1,875	\$1,875
Electronic Mixing Valve	\$10,545	\$10,545	\$10,545	\$10,545	\$10,545
Piping	\$17,175	\$10,275	\$6,700	\$7,800	\$8,500
Miscellaneous supplies	\$300	\$300	\$225	\$250	\$300
Labor	\$31,783	\$21,493	\$16,138	\$19,628	\$19,948
Structural	\$9,500	\$6,500	\$4,000	\$5,500	\$5,500
Adders	\$0	\$0	\$0	\$0	\$0
Total	\$394,663	\$161,477	\$222,820	\$336,588	\$204,119
Total Per Dwelling Unit Cost	\$4,485	\$1,835	\$2,532	\$3,825	\$2,320
Incremental Cost per Dwelling Unit	NA	(\$2,650)	(\$1,953)	(\$660)	(\$2,165)

Table 524: Installed Cost Breakdown for Baseline and Proposed Central HPWH Designs for HighRiseMixedUse

Cost	HPWH Base	HPWH_SPST	HPWH_SPRetP	HPWH_MPRetP	HPWH_SPwMPTM
Primary Storage	\$31,371	\$31,371	\$24,377	\$26,270	\$30,071
Primary HPWH	\$308,492	\$54,910	\$238,312	\$256,676	\$54,910
Temp. Maint. Electric Water Heater	\$23,794	\$23,794	NA	NA	NA
Temp. Maint. HPWH	NA	NA	NA	NA	\$154,246
Temp. Maint. Storage	NA	NA	NA	NA	\$5,767
Electric Back-Up	\$869	\$869	\$529	\$2,607	\$869
Heat exchanger	\$0	\$7,000	\$0	\$0	\$7,000
Pumps	\$18,250	\$10,950	\$9,125	\$12,775	\$18,250
Expansion Tank	\$1,875	\$1,875	\$1,875	\$1,875	\$1,875
Electronic Mixing Valve	\$16,763	\$16,763	\$16,763	\$16,763	\$16,763
Piping	\$15,275	\$9,275	\$6,850	\$7,475	\$9,750
Miscellaneous supplies	\$400	\$400	\$300	\$350	\$400
Labor	\$36,205	\$24,090	\$20,238	\$24,088	\$28,985
Structural	\$11,000	\$7,000	\$5,000	\$6,500	\$10,000
Adders	\$0	\$0	\$0	\$0	\$0
Total	\$458,794	\$184,797	\$320,868	\$352,128	\$333,886
Total Per Dwelling Unit Cost	\$3,921	\$1,579	\$2,742	\$3,010	\$2,854
Incremental Cost per Dwelling Unit	NA	(\$2,342)	(\$1,179)	(\$912)	(\$1,068)

Appendix L: Individual HPWH Ventilation Detail

This appendix provides additional detail on analyses performed for the proposal presented in Section 8.

Justification and Background Information

Ventilation Impacts on HPWH Performance

Results of laboratory tests conducted by Larson Energy Research for NEEA of an unducted HPWH in conditioned space (surrounded by “interior” spaces with air maintained at 68°F) are illustrated in the figures below (Larson and Larson 2022). Tests were conducted using hot water draw profiles derived from the U.S. DOE’s water heater test methods. Data from these tests was provided to the Statewide CASE Team for this analysis.

Figure 39 shows efficiency reduction at two hot water usage levels (55 and 84 gallons per day) relative to an “open air” baseline as room volume decreases from 1000 ft³ (large closet) to 84 ft³ (small closet). Figure 40 shows the efficiency reduction in a small closet (84 ft³) as the “NFA” (NFA) of ventilation grilles and louvers in the closet door decreases. NFA is the total area of the louvered door or wall grille that consists of gaps through which air can freely move.

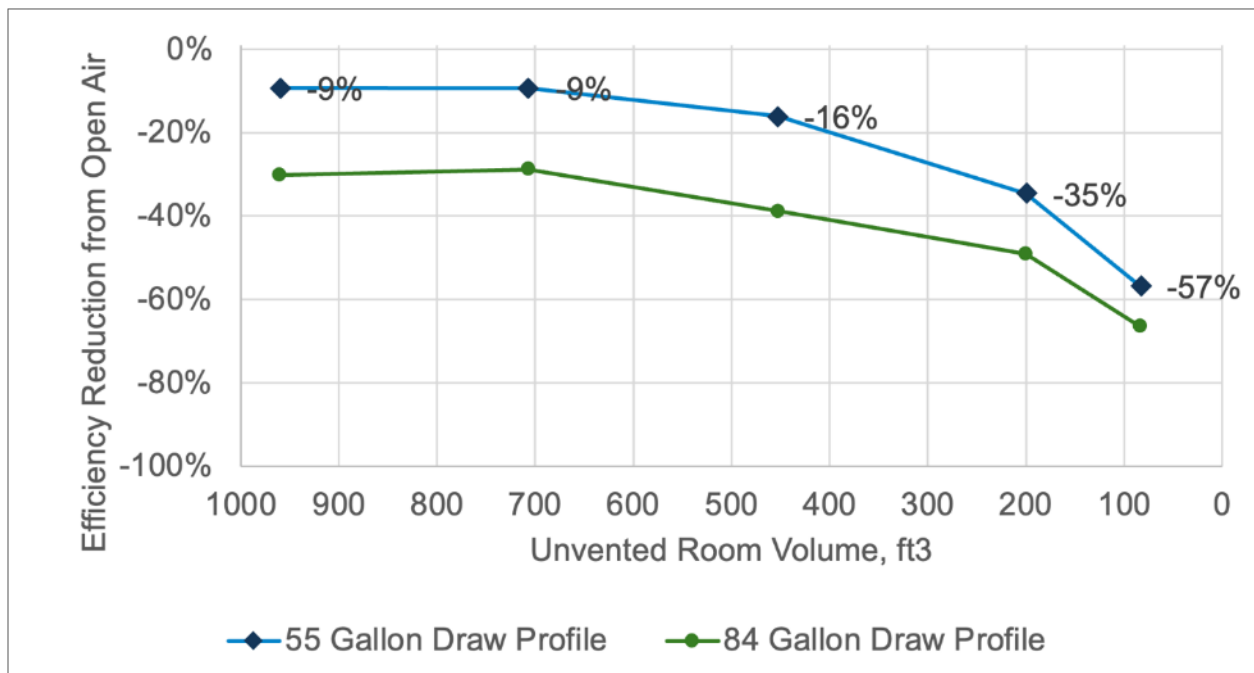

Figure 39: Unducted HPWH efficiency reduction vs unvented room volume.

Compared to the ideal “open” installation scenario used in U.S. DOE rating tests, there is a reduction in efficiency when enclosing the water heater, even in an enclosed space of 1000 ft³. However, at room volumes larger than 450 ft³, the lab testing observed no backup resistance heat use with the 55 gallon per day water draw pattern (Larson and Larson 2022) under the interior space conditions.

All HPWH manufacturers with units listed in the CEC’s MAEDBS, certified by ENERGY STAR, or certified by NEEA specify minimum room volumes of either 700 or 450 ft³ if installed in an enclosed room. This implies that some reduction in installed efficiency over the rated efficiency (9 to 16 percent) is acceptable to manufacturers, as long as backup resistance heat use is avoided. This same definition of acceptable performance (avoidance of resistance heat use) was used in determining the appropriate minimum ventilation requirements for this measure.

Following the shrinking room tests, LER performed a series of tests evaluating ventilation methods with the small closet (84 ft³) configuration. The goal of this testing was to see what ventilation methods could bring small closet HPWH performance back up to the acceptable efficiency levels determined during the shrinking room testing (nine to 16 percent reduction from rated efficiency and no resistance heat operation with the 55 gallon per day draw pattern). Figure 40 shows the efficiency reduction in a small closet as the NFA of ventilation grilles and louvers in the closet door decreases. NFA is the total area of the louvered door or wall grille that consists of gaps through which air can freely move.

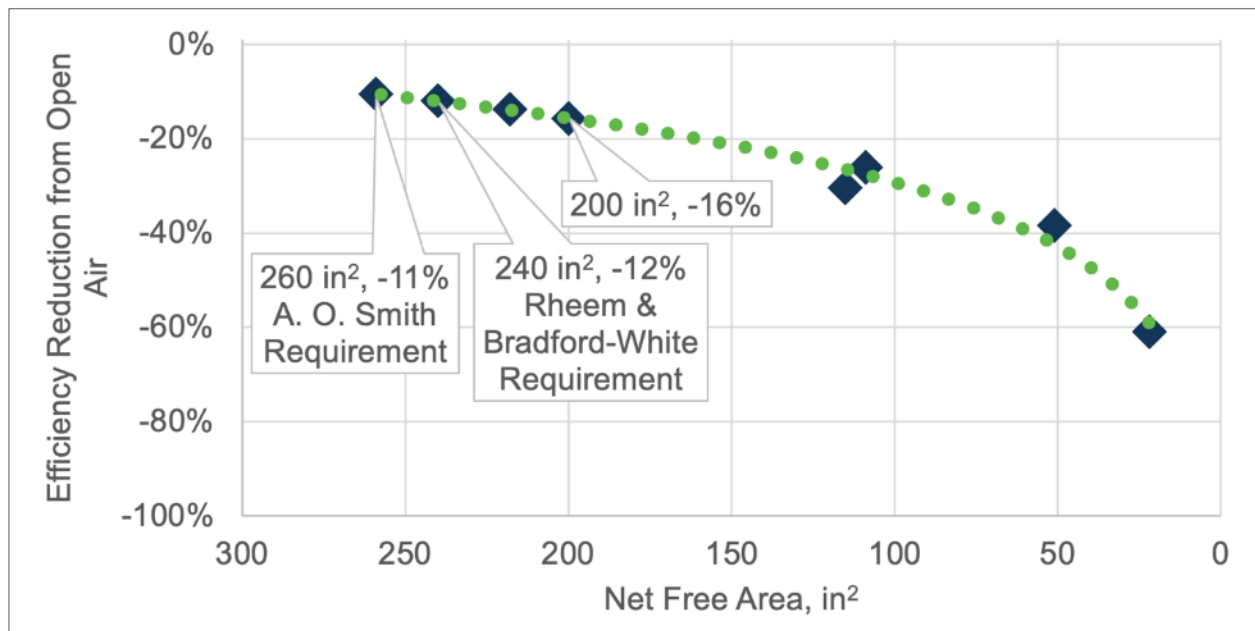

Figure 40: Unducted HPWH efficiency reduction in a small closet vs. net free area of vents connecting the DHW closet to larger interior spaces.

Results showed that acceptable performance was reached when the NFA of the door was greater than 200 in² (16 percent reduction from rated efficiency). Decreasing NFA shows similar declines in performance as with decreasing enclosed room volume (Larson and Larson 2022). All HPWH manufacturers with units listed in the CEC's MAEDBS, certified by ENERGY STAR, or certified by NEEA specify a minimum NFA of door louvers or grilles if the unit is installed in a room smaller than their minimum enclosed room volume, and all these manufacturers specified minimum NFA values are greater than the 200 in² minimum determined through laboratory testing. LER also tested other ventilation options for small closets, including ducting, which provided acceptable performance.

Additional laboratory testing by LER for PG&E's Code Readiness program demonstrated the impact of various ventilation methods on HPWH performance in small exterior closets. Data from these exterior closet tests was provided to the Statewide CASE Team for this analysis. These tests showed significant decreases in HPWH efficiency and increases in electric resistance backup heat use when outdoor temperatures were below 59°F.

These exterior closet tests also showed that ducting, which worked well for HPWHs receiving ventilation air from conditioned space, further reduced HPWH performance. In one 55 gallon per day test at 50°F outdoor air condition, a HPWH installed with a four foot long, 8-inch diameter, exhaust duct performed equivalent to an electric resistance water heater with a COP of 0.95 This is due to the axial fan used in the tested model. A newer generation of the same HPWH, which has a centrifugal blower, was also tested and showed improved performance. Because of the improved performance, manufacturers are moving away from the use of axial fans to centrifugal blowers. (Larson, Larson and Gantley 2023).

Ventilation Requirement Dependence on Compressor Capacity

From basic thermodynamic principles, laboratory testing, and discussions with manufacturers, the CASE Team determined that the needed amount of ventilation also depends on the capacity of the compressor used in the HPWH. The compressor capacity determines the rate at which heat is removed from the surrounding air, and therefore determines size of the air volume in which the HPWH is installed, or the rate of replenishing the thermal resource in that air volume through venting that is necessary to ensure acceptable performance. The same size compressor could be coupled to a wide range of tank and backup element sizes, which results in a range of first hour ratings, but all for the same rate of thermal load on the air volume in which the HPWH is installed.

This dependency on compressor size can be seen in manufacturer air volume requirements, as demonstrated by the trendline R-squared values in Figure 41.

In discussions with manufacturers, it was determined that using the AHRI 540 Table 4 reference conditions for the “High” rating test point would be the best option for standardizing the compressor capacity that manufacturers provide in their documentation. This value is readily available to all manufacturers from their compressor suppliers.

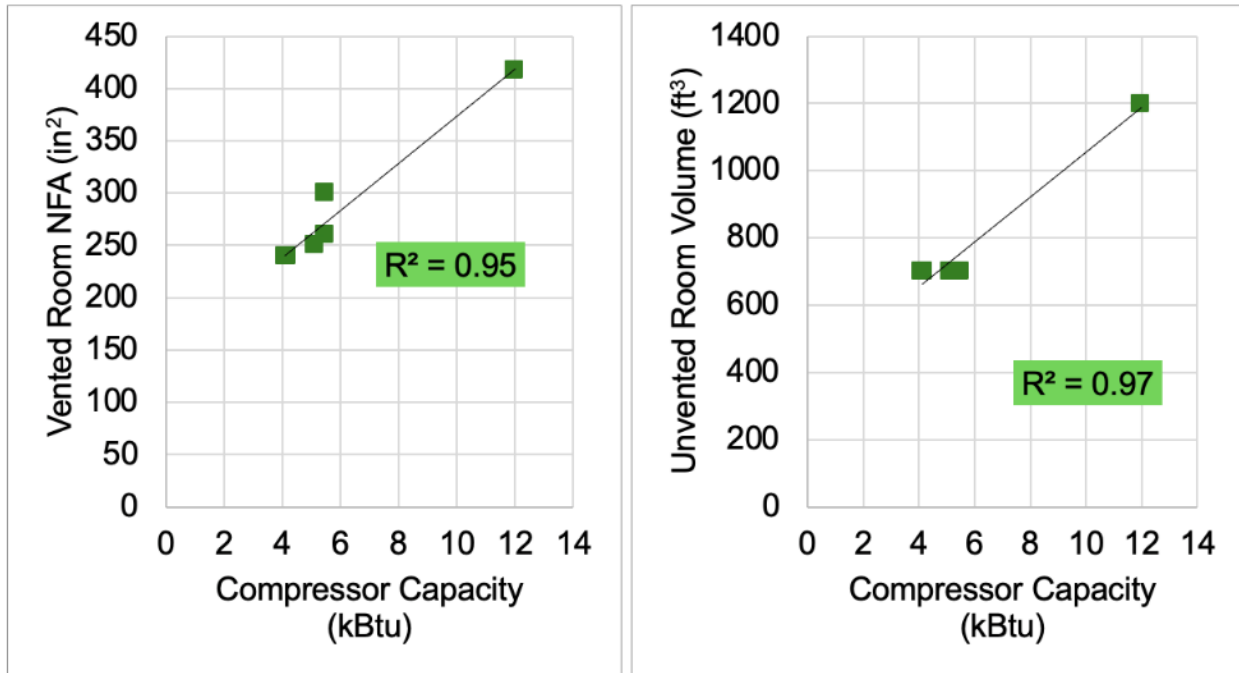

Figure 41. Manufacturer ventilation requirements by compressor capacity.

Impact of Louver and Grille Design

LER laboratory tests also demonstrated that not all louver and grille designs produce the same result despite having the same NFA. (Larson, Larson and Gantley 2023) For example, chevron style louvers restrict airflow more than flat slat louvers, resulting in reduced HPWH performance and increased electric resistance backup operation. This result contributes to the observed performance issues seen in field tests where chevron style louvered doors were used.

Requirement for Backup Heat Below Winter Median of Extremes

Using the LER laboratory results, the Statewide CASE Team estimated the annual COP by climate zone for HPWHs in small exterior closets with 300 in² NFA. These annual COPs are shown in Figure 42 below.

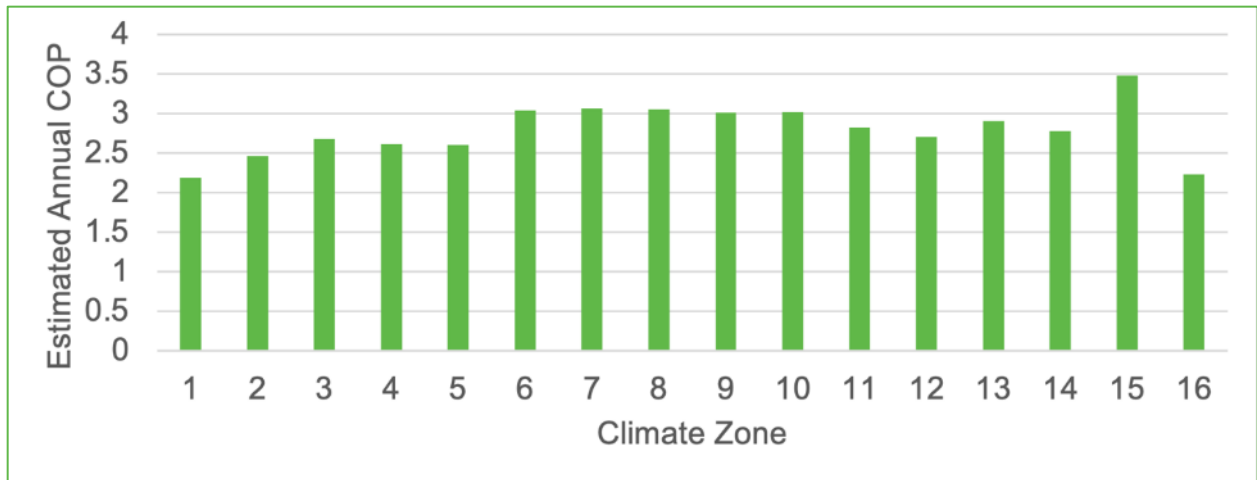

Figure 42. Estimated annual COP for HPWHs in small exterior closets with ventilation grilles based on laboratory test results.

These annual COP results vary significantly by climate zone because all HPWHs currently on the market use R-134a refrigerant. This places the cutout temperature, the temperature below which the compressor shuts off and all heating is done by the backup electric resistance elements, near 40°F. Figure 43 shows the percentage of hours in the typical meteorological year where the average temperature is below 40°F for each climate zone.

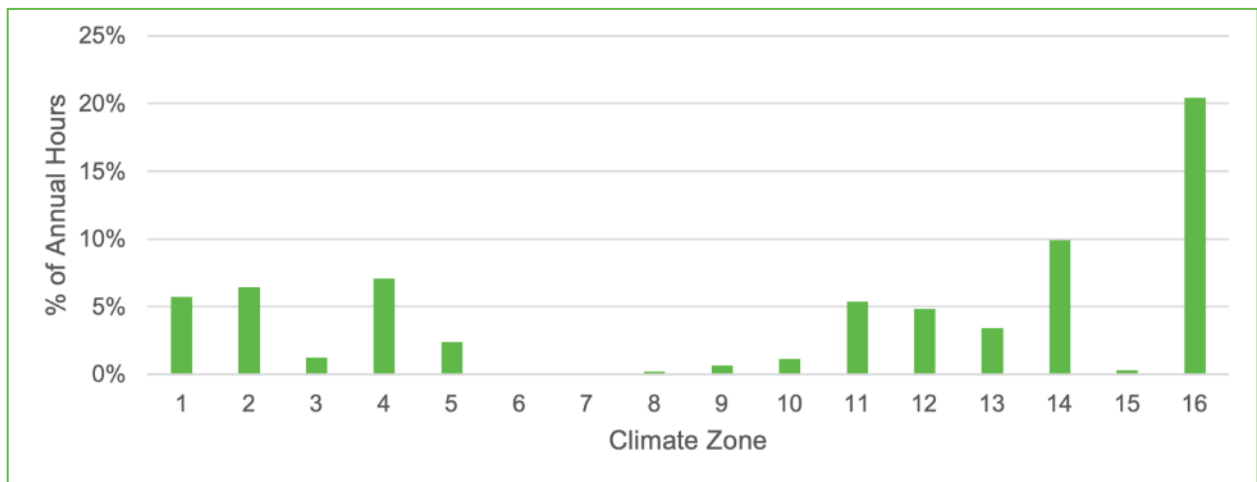

Figure 43: Percentage of annual hours for each climate zone when outdoor air temperature is below 40F.

During these hours, all water heating is done by the backup electric resistance elements. Therefore, the higher percentage of hours below this threshold, the lower the annual COP and higher the annual energy use for installs vented to unconditioned air. Poor ventilation exacerbates this issue, causing inlet air conditions below the ambient conditions.

Another related concern, however, is whether a R-134a HPWH can deliver hot water under these conditions. California Plumbing Code 601.2.1 requires hot water to be available, but there are clearly periods in most climate zones when a R-134a HPWH would not be able to provide hot water without electric resistance backup heat. While most consumer individual HPWHs include such backup heat, some do not. These should not be allowed to be installed without backup heat in locations where they are not capable of delivering hot water for the entire year.

Incremental First Cost

As discussed in Section 8.4.3 of the report, this measure is only concerned with the ventilation being provided to a HPWH and the incremental first costs considered are only those related to the ventilation methods explicitly mentioned in the proposed code change. These methods are installing in:

1. A large unvented space.
2. A small closet space with louvers or grilles to allow air exchange.
3. Any size space with the exhaust ducted out of that space.

To determine the incremental first costs of method 2, the Statewide CASE Team conducted a survey of louvers, grilles, and louvered door options. Costs collected from the survey were for orders of a single unit, which does not account for volume purchasing. The Statewide CASE Team used current costs in our analysis, which are still impacted by the pandemic and inflation. As these influences diminish, there should be a cost decrease.

The survey found that most prefabricated fully louvered doors less than 30 inches wide do not have sufficient NFA for adequate HPWH ventilation. However, some manufacturers offer custom doors that can be ordered with specific NFA. Figure 44 shows the average NFA for the four door widths surveyed.

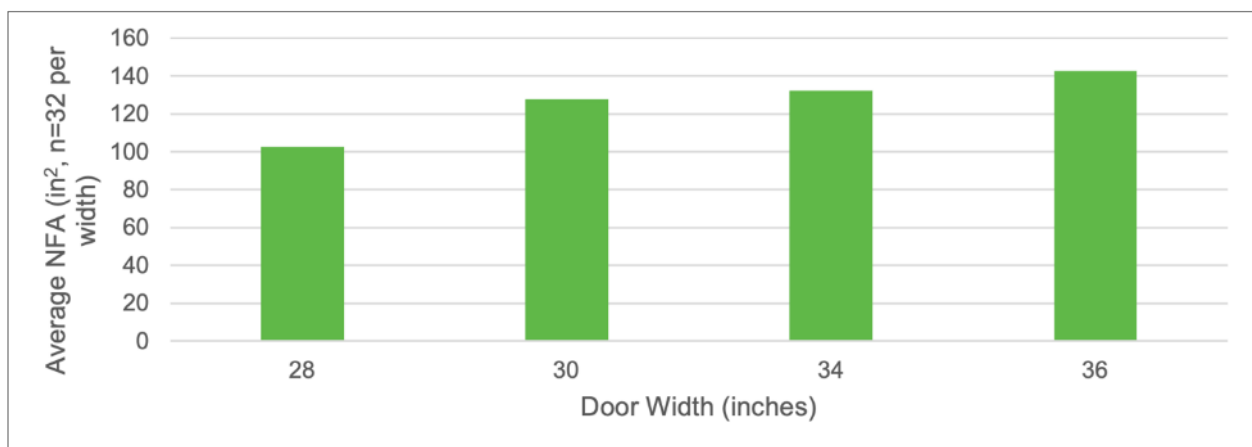

Figure 44: Average NFA for doors in survey by door width.

Generally, the wider the door, the more likely it would provide sufficient NFA. Louvered doors with “traditional” louvers (narrow slats) had a greater chance of providing sufficient NFA, while doors with “plantation” louvers (wide slats) had less NFA.

Costs range significantly from manufacturer to manufacturer, from less than \$200 to more than \$2,000, depending on the manufacturer, style, and materials (i.e., wood for interior, steel for exterior).

The Statewide CASE Team also surveyed retrofit louver sections. These can be added to any existing or new door. Some door vendors provide the option to have retrofit louvered sections added to new doors before they are shipped to the site. Retrofit louvered sections have high free area ratios, 35 to 50 percent (the free area ratio of most fully louvered doors is between eight and 12 percent). Retrofit louvered sections surveyed cost \$1.70 per in² of NFA on average (\$510 for 300 in² NFA). This is expensive, but they may be lower cost in situations that call for a prefabricated steel louvered door.

A low-cost option for adding sufficient NFA to a closet door is through grilles, which are a common method of providing ventilation for gas-fired water heaters, as shown in Figure 45.



Figure 45: DHW closet door with lower grilles from a small commercial kitchen in Woodland, CA.

Source: James Haile, Frontier Energy



Figure 46: Ventilation grilles on the door of the closet used in laboratory tests.

Source: Ben Larson, Larson Energy Research.

Grilles can be added to existing or new doors and cost \$20 to \$50 each, depending on the size, and have a free area ratio of 70 to 90 percent (Bailes III 2017). Using upper grilles and lower grilles, as shown in Figure 46, would provide sufficient ventilation for a HPWH and cost \$100 or less. Laboratory testing has shown that having one upper grille and one lower grille in the closet door performs identically to a fully louvered door with sufficient NFA.

The labor required to install a prefabricated louvered door is no different from the labor required to install any other door, and therefore was not considered an incremental cost. The labor to retrofit an existing door with louvered sections or grilles were estimated to be 0.5 to one hour, based on interviews with contractors. This is consistent with materials and labor times required for the laboratory tests conducted by Larson Energy Research.

According to interviews with manufacturers, incremental costs of materials for ducting a HPWH are \$200 on average, and implementing the method requires one to two hours of labor. This is consistent with costs for ducting kits from HPWH manufacturers seen online and with materials and labor times required for the laboratory tests conducted by Larson Energy Research.

Table 525 provides a summary of the incremental first costs discussed above for each ventilation method covered by the proposed code change.

Table 525. Summary of Incremental First Costs by Ventilation Method.

Ventilation Method	Sub Method	Materials Cost	Labor Cost
Large Space	NA	\$0	0
Small Vented Space	Louvered Door	\$200 to \$2000	NC: \$0 Add/Alt: \$97.50
	Louver Sections	\$1.70 per sq. in. NFA (\$510 for 300 sq.in. NFA)	\$195
	Grilles	< \$100	\$97.50
Ducted Any Size Space	NA	\$200	\$195

Incremental Maintenance and Replacement Costs

Incremental maintenance and replacements costs were also considered for the same three ventilation methods over a 30-year period of analysis.

The first ventilation method involves no equipment or materials other than the HPWH and so inherently has no lifecycle or maintenance costs.

For the second method, the louvers and grilles for ventilation would most likely come preinstalled in the closet door. Most exterior and interior doors last longer than the 30-year analysis period. According to a study by the National Association of Home Builders, steel and wood exterior doors, and most interior closet doors can last over 100 years (National Association of Home Builders 2007). The International Association of Certified Home Inspectors' (InterNACHI) Standard Estimated Life Expectancy Chart for Homes, updated annually, also places the life of wood exterior doors and interior closet doors at over 100 years (InterNACHI 2023). The closest analog to door louvers and grilles in these studies are HVAC diffusers, grilles, and registers, which according to both studies, have a life expectancy of 25 years. ASHRAE places the life expectancy of diffusers, grilles, and registers at 27 years (ASHRAE 2019).

However, these life expectancies are for components of indoor heating and cooling equipment. Such grilles and registers typically have movable parts that are operated regularly by the occupants and because of this operation suffer increased wear and tear. The louvers and grilles typically used for HPWH ventilation, and which are proposed in this measure, are fixed flat slats, and so should have a much longer life expectancy, likely more than the 30-year analysis period. As all components for this method have a lifecycle longer than the analysis period, there are no lifecycle costs to consider.

Though anecdotal, the Statewide CASE Team has found several examples of louvered closet doors and retrofit grilles installed on DHW closet doors that have lasted for many decades. Three such examples, the one from an office, one from a small kitchen, and one from an amusement park, are shown in Figure 47.

The office example is a fully louvered door with approximately 280 sq. in. NFA. The kitchen example shows a solid wood DHW closet door with lower retrofit grilles to provide ventilation air for a gas storage water heater. If a HPWH were installed in this closet, the only change to the door would be a second retrofit grille in the upper half of the door, one foot from the top. The amusement park example shows a site-built wood door with custom made wood louvers for an equipment closet. All three examples show no significant signs of wear, despite their age, as the doors are rarely operated. A HPWH could be installed in the first two closets without the need to replace the door.



Figure 47: Examples of louvered closet doors and retrofit grilles installed.

Left, 34-year-old fully louvered closet door from a small office in Davis, CA. Middle, over 40-year-old DHW closet door with retrofit lower grilles from a small commercial kitchen in Woodland, CA. Right, over 60-year-old wood exterior door with louvered section from an amusement park in Anaheim, CA.

Source: James Haile, Frontier Energy

For the third method, the only components are ductwork and vent terminations. According to ASHRAE, the life expectancy of ductwork is 30 years (ASHRAE 2019), while the InterNACHI study places the life expectancy of ductwork between 60 and 100 years (InterNACHI 2023). This proposal includes requirements for insulating the exhaust ductwork of the HPWH, which prevents condensation on the exterior surface of the duct. The interior surface of the exhaust duct is unlikely to experience condensation as the HPWH dehumidifies the air in the exhaust. However, insulating the exhaust ducts is best practice to prevent condensation outside the duct from damaging other house components, such as attic insulation. Interior vent terminations are fixed flat slat grilles and have a life expectancy longer than the 30-year analysis period. Exterior vent terminations are like dryer vents. The Statewide CASE Team could not find information specific to the life expectancy of dryer vents but considering the life expectancy of other ducting components and terminations, it is likely longer than 30 years. Therefore, as all components for this method have a lifecycle longer than the analysis period, there are no lifecycle costs to consider.

The Statewide CASE Team found that all equipment components related to this measure have a usable life expectancy longer than the 30-year analysis period and therefore there are no lifecycle costs to consider.

Appendix M: Individual DHW and Central DHW Electric Ready Basis of Design and Cost Details

The electrical engineering design engineer provided detailed electrical load calculations for each living unit size (Studio, 1, 2 and 3-Bedrooms) for all prototypes and scenarios that the Statewide CASE Team requested. Representative calculations for central electric ready and individual electric ready are included in this section.

Building Electrical System Components

The Statewide CASE Team determined that the following key electrical components are within the scope of Title 24. Impacts to the utility equipment and wiring are outside of the scope of Title 24. The list below is a generalized list of major components. Some of the components only apply to some of the prototypes; Please also refer to the one-line diagrams in this Appendix.

- **Building Main Service:** The capacity of the building's main electrical service equipment needs to accommodate the future HPWH load. This includes the following items that are impacted:
 - **Main Service Conduit:** Typically, the main service conduit for a new multifamily building is located underground. Because it is located underground, retrofitting the main service conduit is one of the most significant barriers to increasing the service size at retrofit. Increasing the size of the conduit at retrofit requires trenching, and depending on site specific details could also require saw-cutting. Furthermore, since much of the installation costs of installing the main service conduit at new construction are due to trenching, the incremental cost to increase the main service conduit size for electric readiness at new construction is low and is very low when compared to the cost to increase the size later at retrofit.
- Note that the Main Service Feeder is sized and owned by the utility as described below, is not regulated by Title 24, and is therefore outside the scope of the CASE proposals. Assuming the conduit is sized correctly for electric readiness, standard practice at retrofit would require the utility company to remove the original feeder and replace it with an adequately sized feeder. Since the new and existing feeders can be pulled through an adequately sized conduit, this is relatively low cost if the conduit is adequately sized to meet the future electrical load.

- **Switchboard:** The switchboard is a large component with significant cost, which would be technically challenging and costly to retrofit. Some technical challenges associated with increasing the size of the switchboard include space constraints and re-wiring work which would also disrupt power to the building. The switchboard may include the following sections (see diagram)
 - Pull Section
 - Main Breaker
 - Feeder Breakers
 - Utility Meters Section
- **Building Transformers:** Depending on the service voltage, transformers may be required in the building to step down voltage. For multifamily buildings, the service voltage is typically either 240 volts or 480 volts. Building transformers are required where the service voltage is 480 volts. The size and number of building transformers is a design choice made by the electrical engineer based on the layout of the building among other factors. Retrofit of the building transformers represents a significant cost and can be technically challenging due to space constraints.
- **Conduit to large central appliances:** Large appliances, such as central HPWH, represent a significant electrical load. The Statewide CASE Team worked with an electrical designer to develop representative designs for each prototype. For centralized appliances, the Statewide CASE Team prototype basis of design assumes that power is fed from the switchboard to the centralized appliances at the building service voltage. This assumption reduces transformer, feeder, and conduit costs and is consistent with how a typical design team would develop the electrical system.
- **Feeder to large central appliances:** A feeder is a circuit with an overcurrent protection device downstream, that feeds power to another location. Many large loads would include a local panel, with overcurrent protection devices, near the equipment.
- **Central Equipment Main Panel:** The downstream overcurrent protection and final distribution point to central equipment as needed.
- **Distribution Boards:** Also known as a distribution panel. Depending on the size and layout of the building, distribution boards may be installed throughout the building to reduce the overall installed costs of installing feeders to each dwelling unit main panel. Increasing the size of the distribution boards at retrofit can be expensive and technically challenging due to space constraints.

- **Conduit from Main Service to Distribution Board, or Conduit from Main Service to Dwelling Unit Main Panel:** Conduit is installed to contain the feeder from the Switchboard to distribution boards if they are installed, or directly to dwelling units if distribution boards are not installed. Due to the number of conduit runs in a building, increasing the conduit size to each dwelling unit at retrofit represents a significant cost barrier. Right sizing the conduit to each Dwelling Unit Main Panel for the future electric appliances is one of the most critical aspects of the existing electric ready requirements.
- **Feeder from Main Service to Distribution Board, or Feeder from Main Service to Dwelling Unit Main Panel:** A feeder is a circuit with an overcurrent protection device downstream, that feeds power to another location. Feeder is installed within conduit from the Switchboard to distribution boards if they are installed, or directly to dwelling units if distribution boards are not installed. Like the conduit to each dwelling unit, right sizing the feeder to each Dwelling Unit Main Panel for the future electric appliances is one of the most critical aspects of the existing electric ready requirements since retrofitting this feeder later would require pulling the existing feeder serving each affected dwelling unit and replacing it with a larger feeder.
- **Dwelling Unit Main Panel:** The dwelling unit main panel receives power via a feeder and distributes power to the branch circuits within the dwelling unit. The dwelling unit main panel contains a bus bar and individual breakers serving each branch circuit within the dwelling unit. Labeling is used to indicate branch circuits, including future branch circuits required for electric readiness. Due to the number of dwelling unit main panels in a building and the costs to retrofit each, right sizing each Dwelling Unit Main Panel for the future electric appliances is one of the most critical aspects of the existing electric ready requirements.

Impacts to the utility equipment and wiring are outside of the scope of Title 24. The following electrical components were reviewed by the Statewide CASE Team but were **not included** for the reasons listed.

- **Utility Installed Transformer:** Design and installation are by the utility.
- **Main Service Feeder:** Design and installation are by the utility based on the anticipated load at new construction. The Main Service Feeder is housed within the Main Service Conduit. Assuming the Main Service Conduit is sized correctly for electric readiness, standard practice at retrofit would require the utility company to remove the original feeder and replace it with an adequately sized feeder. Since the new and existing feeders can be pulled through a right sized conduit, this is relatively low cost if the Main Service Conduit is adequately sized to meet the future electrical load.

The riser diagrams in Figure 48 and Figure 49 illustrate the electric ready components and distinguishes between components that are within the scope of Title 24 and the components that are within the utilities scope.

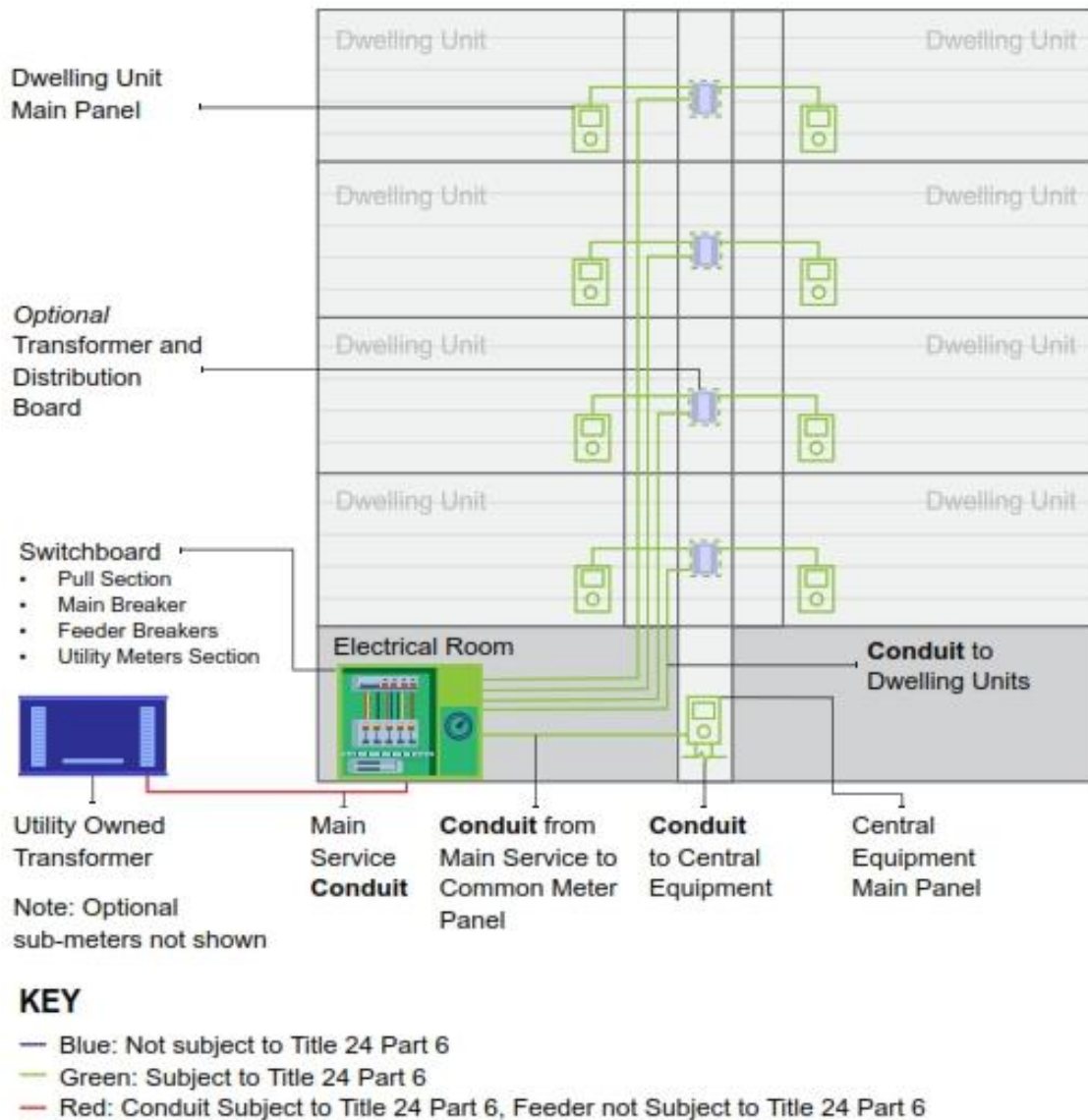

Figure 48: Mid and high-rise electrical riser diagram.

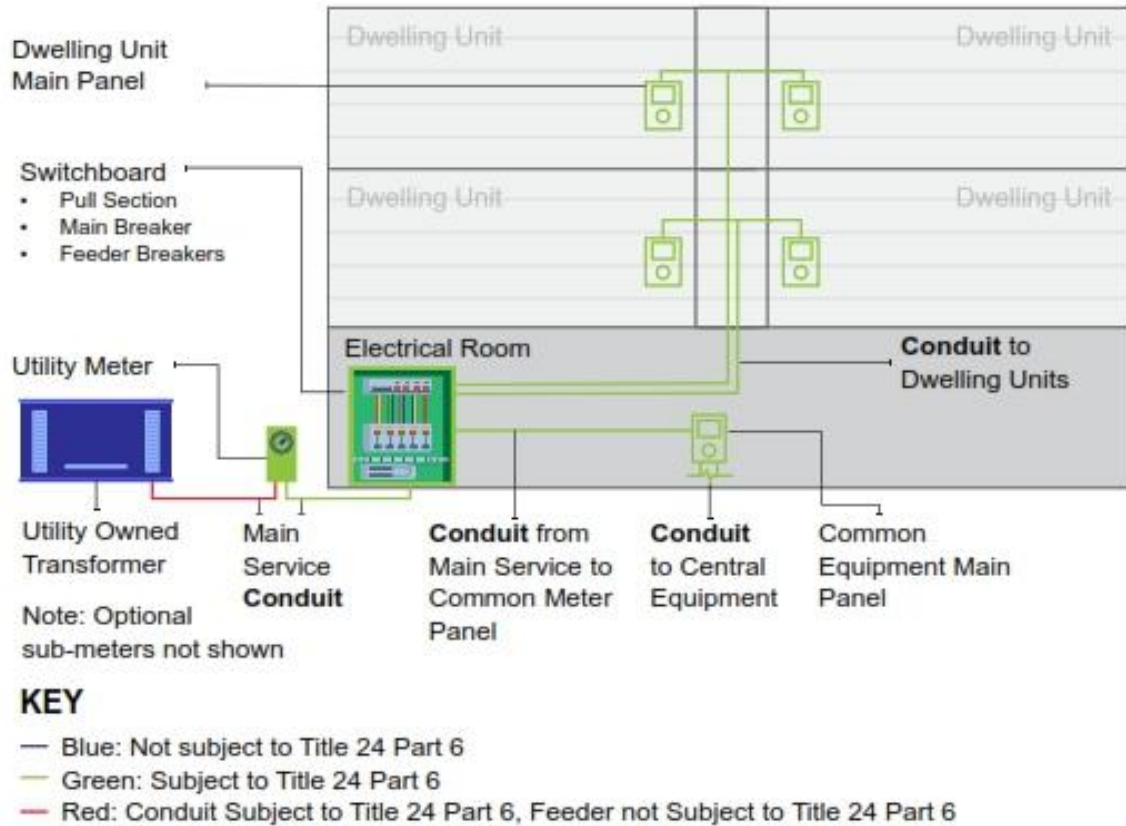

Figure 49: Low-rise electrical riser diagram.

The building prototype specifications are shown in Table 526 below.

Table 526: Building Prototypes Basis of Design Specifications

Building Component	Low-Rise Garden Style	Low-Rise Loaded Corridor	Mid-Rise Mixed Use	High-Rise Mixed Use
Number of Dwelling Units	8	36	88	117
Number of Studio Units	0	6	8	18
Number of 1-Bedroom Units	4	12	40	54
Number of 2-Bedroom Units	4	12	32	45
Number of 3-Bedroom Units	0	6	8	0
Conditioned Floor Area ft ²	7320	39372	113700	125400
Foundation	Slab on Grade	Slab on Grade	Concrete Podium with Underground Parking	Concrete Podium with Underground Parking

Building Component	Low-Rise Garden Style	Low-Rise Loaded Corridor	Mid-Rise Mixed Use	High-Rise Mixed Use
Wall Assembly	Wood Frame	Wood Frame	Wood Frame Over Concrete Parking	Steel Frame
Roof Assembly	Low Slope Attic Roof	Flat Roof	Flat Roof	Flat Roof
Window To Wall Ratio	15%	25%	25%	40%
Ventilation	Exhaust Only	Exhaust Only	Exhaust Only	Central Supply Ventilation Ducted to Corridors and Units
Space Heating and Cooling	Individual Ducted Split Heat Pump	Individual Ducted Split Heat Pump	Individual Ducted Split Heat Pump	Individual Ducted Split Heat Pump
Domestic Hot Water	See Specifications	See Specifications	See Specifications	See Specifications

Central Electric Ready

The Statewide CASE Team explored many electric ready components and how they would impact electrification feasibility and cost-effectiveness. The Statewide CASE Team originally included two additional requirements in the proposed central electric ready measure:

- Central Equipment Main Panel (See definition above)
- Conduit to Large Central Appliance (See definition above)

Cost estimates that included these components were collected, however, upon completing the analysis, it was found that including these components was not always cost-effective. This is because the building main service does not always need to be upsized for the future equipment (zero cost/savings) while the central equipment main panel and the conduit to large central appliance would always be required. The team assumed that retrofitting these components would be more expensive than installing them during new construction and would thus be costs effective, which is true, however, once the present value (PV) formula (only applicable to retrofit costs) was applied there was no longer a cost savings. Table 527 below is an example of the analysis performed that resulted in a cost rather than savings.

Table 527: Cost Summary for Electric Ready vs. Non - Electric Ready Cases - Mid-Rise Mixed Use High Recovery System CZ 09 Example Cost at Time of Construction

Cost Category	Cost Component	Base Case Cost	Proposed Case Cost	Incremental Costs
Costs at Time of Construction (2026 PV\$)	Building Main Service	\$102,316	\$102,316	\$9,604
	Central Equipment Main Panel	\$ -	\$1,845	
	Conduit to large central appliances	\$ -	\$7,759	
	Total Cost of Components	\$102,316	\$111,920	
Retrofit Costs. (2026 PV\$)	Building Main Service	\$ -	\$ -	-\$6,675
	Central Equipment Main Panel	\$1,021	\$ -	
	Conduit to large central appliances	\$5,654	\$ -	
	Total Cost of Components	\$6,675	\$ -	
All	Net Incremental Cost	N/A	N/A	\$2,929

Had the cost of retrofit for these components been greater when compared to new construction, the difference in cost would have offset the getting the 55 percent PV discount rate that was applied to the retrofit costs.

The water heating specifications provided to the electrical engineering and design firm for electrical load calculations, cost estimates, and single line diagrams are shown in Table 528 through Table 530 below.

Table 528: Base Case Central Gas Water Heater /System Specifications

Baseline	Equipment	Specification	Low-Rise Garden Style	Low-Rise Loaded Corridor	Mid-Rise Mixed-Use	High-Rise Mixed-Use
Central Gas Boiler System	Gas Boiler	Manufacturer	Lochinvar	Bosch	Bosch	Bosch
		Model	SWR125N	Buderus GC144/4	Buderus G234X/38	Buderus G234X/45
		Quantity	1	2	3	3
		BTU/h Recovery Each	125000	76000	113000	134000
		Volts Low	120	120	120	120
		Volts High	NA	NA	NA	NA
		Phase	1	1	1	1
		Min Circuit Amps (MCA)	15	15	15	15
		Total Volt Amps	1800	3600	5400	5400
	Primary Storage	Manufacturer	Lochinvar	Niles	Niles	Niles
		Model	RJS080M	S-24-062-TC	S-28-079-TC	S-28-079-TC
		Quantity	1	2	3	4
		Volume (gal) Each	80	119	200	200

Table 529: Standard Recovery Central Heat Pump Water Heater System Specifications

Proposed Case	Equipment	Specification	Low-Rise Garden Style	Low-Rise Loaded Corridor	Mid-Rise Mixed-Use	High-Rise Mixed-Use
Single-Pass Primary - Temperature Maintenance Tank in Series	Primary Heat Pump Water Heater	Manufacturer	SanCO2	SanCO2	Mitsubishi	Mitsubishi
		Model	GS4	GS4	Heat2O QAHV-N136TAU-HPB	Heat2O QAHV-N136TAU-HPB
		Quantity	1	5	2	2
		HPWH Recovery BTU/h Each	15000	15000	110000	110000
		Volts Low	230	230	230	230
		Volts High	NA	NA	NA	NA
		Phase	1	1	3	3
		Min Circuit Amps Each (MCA)	7.8	7.8	67	67
		MOCP Each	15	15	110	110
	Temperature Maintenance Electric Resistance Heater	Manufacturer	RHEEM	RHEEM	NILES ST	NILES ST
		Model	ELD80-TB	ELD120-TB	JEV150-15KW	JEV150-30KW
		Quantity	1	1	1	1
		Volts Low	240	240	240	240
		Volts High	480	480	480	480
		Min Circuit Amps Each (MCA) @ Low Volts	50	50	63	50
		Min Circuit Amps Each (MCA) @ High Volts	13	13	18	14
	Primary Storage	Manufacturer	RHEEM	AO SMITH	NILES ST	NILES ST
		Model	TJV-120A	HDV30-300A	JS36-090	JS36-114
		Quantity	1	1	2	2
		Volume (gal) Each	119	294	360	465
	Expansion Tank	Model	ST-35-CL	ST-50-CL	ST-130-CL	ST-130-CL, ST-12C

Table 530: High Recovery Central Heat Pump Water Heater System Specifications

Case	Equipment	Specification	Low Rise Garden Style ^a	Low-Rise Loaded Corridor	Mid-Rise Mixed-Use	High-Rise Mixed-Use
High Recovery - Single-Pass Primary - Temperature Maintenance Tank in Series	Primary Heat Pump Water Heater	Manufacturer	NA	Mitsubishi	Mitsubishi	Mitsubishi
		Model	NA	Heat2O QAHV-N136TAU-HPB	Heat2O QAHV-N136TAU-HPB	Heat2O QAHV-N136TAU-HPB
		Quantity	NA	1	2	3
		HPWH Recovery BTU/h Each	NA	110000	110000	110000
		Volts Low	NA	230	230	230
		Volts High	NA	NA	NA	NA
		Phase	NA	3	3	3
		Min Circuit Amps Each (MCA)	NA	67	67	67
	MOCPS Each	NA	110	110	110	
	Temperature Maintenance Electric Resistance Heater	Manufacturer	NA	RHEEM	NILES ST	NILES ST
		Model	NA	ELD120-TB	JEV150-15KW	JEV150-30KW
		Quantity	NA	1	1	1
		Volts Low	NA	240	240	240
		Volts High	NA	480	480	480
		Min Circuit Amps Each (MCA) @ Low Volts	NA	50	63	125
	Min Circuit Amps Each (MCA) @ High Volts	NA	13	18	36	
	Primary Storage	Manufacturer	NA	NILES ST	NILES ST	NILES ST
		Model	NA	JS-30-063	JS-36-102	JS-36-126
		Quantity	NA	1	2	2
		Volume (gal) Each	NA	175	415	515

a. Not recommended. 45-gallon tank is too small.

In addition to the specifications above, the electrical engineering and design firm were provided with floor plan configurations for the three heating plant system types and existing code required solar thermal water heating system layouts (see Figure 50).

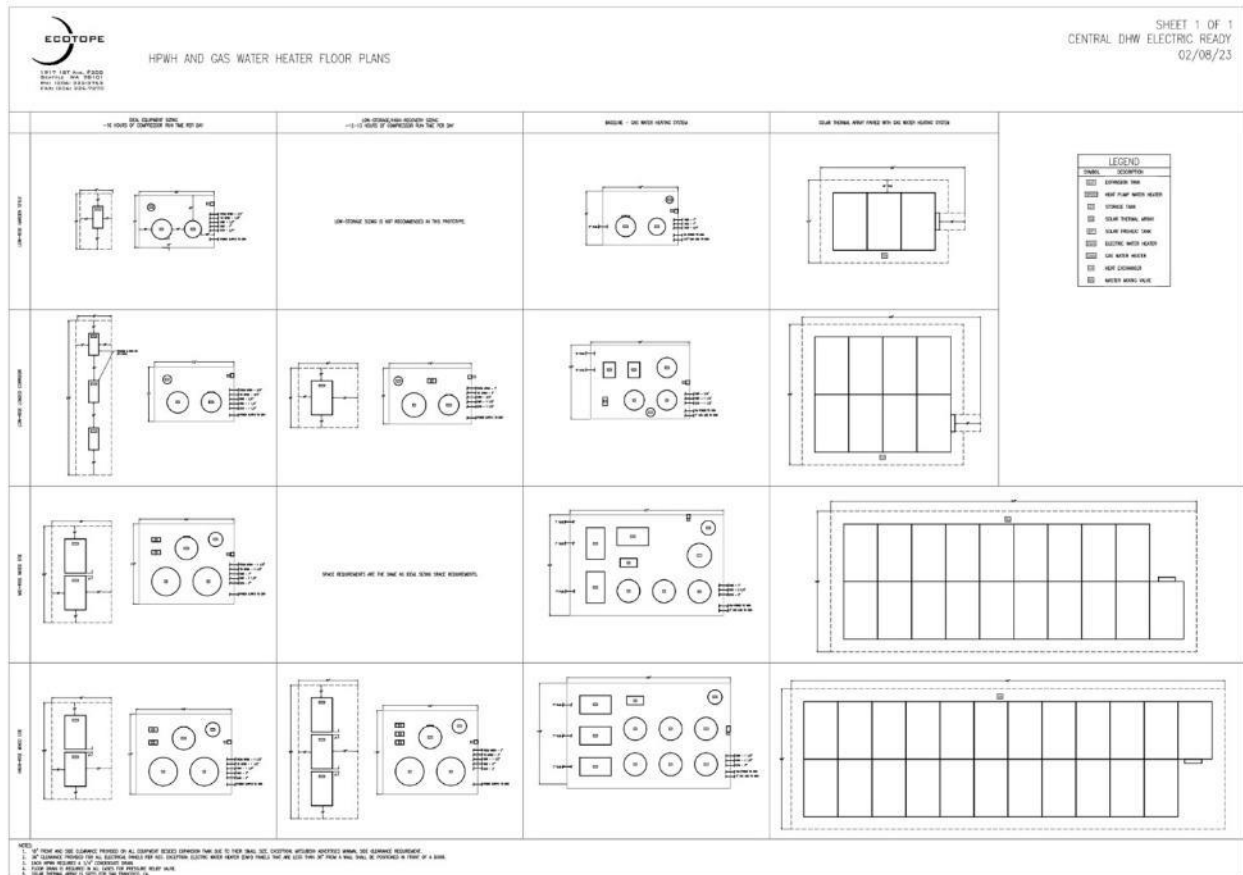

Figure 50: Water heating system floor plans by building prototype.

From the provided specifications, the electrical engineering and design firm developed the electrical load calculations for the four dwelling unit sizes (Table 531 through Table 534) and common space loads to determine a combined total building load after applying the appropriate diversity factor.

Table 531: Studio Dwelling Unit Panel Schedule and Electrical Load Calculations

Leg	Equipment	Studio Volt Amps	1-Bedroom Volt Amps	2-Bedroom Volt Amps	3-Bedroom Volt Amps
A	Kitchen Appliance	1,500	1,500	1,500	1,500
B	Kitchen Appliance	1,500	1,500	1,500	1,500
A	Microwave	800	800	800	800
B	Microwave	800	800	800	800

Leg	Equipment	Studio Volt Amps	1-Bedroom Volt Amps	2-Bedroom Volt Amps	3-Bedroom Volt Amps
A	Refrigerator	-	-	-	-
B	Refrigerator	800	800	800	800
A	Garbage Disposal	500	500	500	500
B	Garbage Disposal	-	-	-	-
A	Dishwasher	-	-	-	-
B	Dishwasher	1,200	1,200	1,200	1,200
A	Heat Pump Space Conditioning	1,200	1,800	2,400	3,000
B	Heat Pump Space Conditioning	1,200	1,800	2,400	3,000
A	Receptacle/Lighting	810	1,125	1,620	2,100
B	Receptacle/Lighting	810	1,125	1,620	2,100
A	Receptacle, Restroom	1,500	1,500	1,500	1,500
B	Receptacle, Restroom	-	-	-	-
A	Receptacle Washer	-	-	-	-
B	Receptacle Washer	1,500	1,500	1,500	1,500
A	Dryer	2,500	2,500	2,500	2,500
B	Dryer	2,500	2,500	2,500	2,500
A	Gas Water Heater	-	-	-	-
B	Gas Water Heater	200	200	200	200
A	Electric Range	3,600	3,600	3,600	3,600
B	Electric Range	3,600	3,600	3,600	3,600

Table 532: Dwelling Unit Electrical Load Totals

Specification	PANEL: ST	PANEL: 1BR	PANEL: 2BR	PANEL: 3BR
Voltage/Phase	120/240V, 1Ø,3W	120/240V, 1Ø,3W	120/240V, 1Ø,3W	120/240V, 1Ø,3W
Floor Area (ft ²)	540	750	1,080	1,400
Total Volt Amps	25,720	27,550	29,740	31,900
Total Amps @ 240V	107	115	124	133

The living unit load calculations were then multiplied by the number of units of each size in the building prototype and common area loads were added, such as HVAC, corridor lighting, EV Charging and in the central electric ready case, the heat pump water heating system as shown in Table 533 and Table 534.

Table 533: Mid-Rise Mixed Use Central High Recovery Building Electrical Load Calculation (Proposed Electric Water Heating, 88 Dwelling Units)

Space Use	Unit Type	# of Units	Individual Unit Load	Space Area	Watts/sq ft	Total Load
Residential	3BR	8	31.9	-	-	255.2
	2BR	32	29.7	-	-	951.7
	1BR	40	27.6	-	-	1102
	ST	8	25.7	-	-	205.8
	Total connected load	88	-	-	-	2514.6
	Total residential demand load per diversity factor	-	-	-	-	578.4
Nonresidential	Commercial	-	-	900	15	13.5
	Corridor	-	-	0	10	0
	Utility space	-	-	1000	10	10
	Office	-	-	1000	15	15
	Retail	-	-	17580	25	439.5
	Gym	-	-	900	25	22.5
	Electric HPWH	-	-	-	-	59.9
	Total nonresidential load	-	-	-	-	560.4
Misc.	EV Chargers	-	-	-	-	213
All	Total Service Size (KVA)	-	-	-	-	1450.8
	Total Service Size (Amps at 480V)	-	-	-	-	1745

Table 534: Mid-Rise Mixed Use Central Gas Water Heating Building Electrical Load Calculation (High Recovery, Baseline Gas Water Heating)

Space Use	Unit Type	# of Units	Individual Unit Load	Space Area	Watts/sq ft	Total Load
Residential	3BR	8	31.9	-	-	255.2
	2BR	32	29.7	-	-	951.7
	1BR	40	27.6	-	-	1102
	ST	8	25.7	-	-	205.8
	Total connected load	-	-	-	-	2514.6
	Total residential demand load per diversity factor	-	-	-	-	578.4
Nonresidential	Commercial	-	-	900	15	13.5
	Corridor	-	-	0	10	0
	Utility space	-	-	1000	10	10
	Office	-	-	1000	15.0	15.0
	Retail	-	-	17580	25	439.5
	Gym	-	-	900	25	22.5
	Electric HPWH	-	-	-	-	0.0
	Total nonresidential load	-	-	-	-	500.5
Misc.	EV Chargers	-	-	-	-	312
All	Total Service Size (KVA)	-	-	-	-	1390.9
	Total Service Size (Amps at 480V)	-	-	-	-	1673

Once the electrical engineering designers determined the electrical equipment sizing, they provided the Statewide CASE Team with raw cost data as requested. Table 535 contains the definitions of each cost component provided, and Table 536 through Table 538 contain cost data received for the mid-rise mixed use building prototype for central and individual electric ready.

Table 535: Raw Cost Data Component Definitions

Component of Cost	Description
Main Service	Main service entrance conduit, switchboard, pull section, main breaker and meter installations
Unit Panels 100A	Panel and main braker installations, includes standard set of breakers that does not change.
Unit Panels 125A	Panel and main braker installations, includes standard set of breakers that does not change.
Unit Panels 150A	Panel and main braker installations, includes standard set of breakers that does not change.
Unit Panels 175A	Panel and main braker installations, includes standard set of breakers that does not change.
Conduit for 100A-150A Unit Panel – 1 ¼-inch	Steel EMG Conduit and fittings including elbows, jboxes, and structural support for conduit attachment.
Conduit for 175A Unit Panel – 1 ½-inch	Steel EMG Conduit and fittings including elbows, jboxes, and structural support for conduit attachment.
Feeder for 100 A Unit Panel - #2 AWG	Copper feeder including lug nuts for termination
Feeder for 125 A Unit Panel - #1 AWG	Copper feeder including lug nuts for termination
Feeder for 150 A Unit Panel - #1/O AWG	Copper feeder including lug nuts for termination
Feeder for 175 A Unit Panel - #2/O AWG	Copper feeder including lug nuts for termination
50A/2P Breaker for Electric Range	Breaker only
30A/2P Breaker for Electric Dryer	Breaker only
Panel for Electric Water Heater – 100A	Panel and breaker for water heater only
Conduit for Electric Water Heater Panel – 1 ¼-inch	Steel EMT conduit and fittings including elbows, jboxes, and structural support for conduit attachment
Feeder for Electric Water Heater Panel - #2 AWG	Copper feeder including lug nuts for termination
Conduit for In Unit Water Heater – ¾-inch	Steel EMT conduit and fittings including elbows, jboxes, and structural support for conduit attachment
Feeder for In Unit Water Heater - #12 AWG	Copper feeder including lug nuts for termination
Main Service Trenching Upgrades (Retrofit-specific)	Excavation and removal of main service entrance conduit, installation of larger sized conduit and includes concrete floor coring into electrical room
Demolition (Retrofit-specific)	Demolition work primarily related to routing the conduit (including opening ceilings and walls) from the switch panel to the HPWH breaker panel and from the breaker panel to the HPWH. In individual unit case, this would be from the living unit breaker panel.

Table 536: Mid-Rise New Construction Base Case Raw Costs

Equipment Cost	Quantity	Linear Ft	Unit Material Cost	Labor Hours	Material Cost	Labor Cost	Total Cost
Main Service	1	0	\$60,000.0	40	\$60,000	\$3,800	\$63,800
Unit Panels 100A	0	0	\$700.0	5	\$-	\$-	\$-
Unit Panels 125A	48	0	\$950.0	5	\$45,600	\$22,800	\$68,400
Unit Panels 150A	40	0	\$950.0	5	\$38,000	\$19,000	\$57,000
Unit Panels 175A	0	0	\$950.0	5	\$-	\$-	\$-
Conduit for 100A - 150A Unit Panel -1 1/4"	88	75	\$4.2	0.178	\$27,390	\$111,606	\$138,996
Conduit for 175A Unit Panel -1 1/2"	0	0	\$5.0	0.178	\$-	\$-	\$-
Feeder for 100A Unit Panel - #2 AWG	0	75	\$12.0	0.096	\$-	\$-	\$-
Feeder for 125A Unit Panel - #1 AWG	48	75	\$12.4	0.146	\$44,640	\$49,932	\$94,572
Feeder for 150A Unit Panel - #1/O	40	75	\$14.4	0.18	\$43,200	\$51,300	\$94,500
Feeder for 175A Unit Panel - #2/O	0	75	\$23.0	0.205	\$-	\$-	\$-
50A/2P Breaker for Electric Range	88	0	\$20.5	1	\$1,804	\$8,360	\$10,164
30A/2P Breaker for Electric Dryer	88	0	\$18.5	1	\$1,628	\$8,360	\$9,988
Panel for Elec Water Heater - 200A	0	0	\$950.0	5	\$-	\$-	\$-
Conduit for Elec WH Panel - 2"	0	60	\$4.2	0.178	\$-	\$-	\$-
Feeder for Elec WH Panel - #3/O	0	60	\$12.0	0.096	\$-	\$-	\$-
Conduit for In Unit Water Heater - 3/4"	0	40	\$1.4	0.145	\$-	\$-	\$-
Feeder for In Unit Water Heater - #12AWG	0	40	\$1.1	0.043	\$-	\$-	\$-
Total	N/A	N/A	N/A	N/A	\$262,262	\$275,158	\$537,420
Sales Tax	N/A	N/A	9.8%	N/A	N/A	\$-	\$25,571
Sub total	N/A	N/A	0.0%	N/A	N/A	\$-	\$562,991
Overhead	N/A	N/A	15.0%	N/A	N/A	\$-	\$84,449
Contingency	N/A	N/A	10.0%	N/A	N/A	\$-	\$56,299
Profit	N/A	N/A	18.0%	N/A	N/A	\$-	\$101,338
Market Factor	N/A	N/A	8.2%	N/A	N/A	\$-	\$46,165
Total Project Cost	N/A	N/A	N/A	N/A	N/A	N/A	\$851,242

Table 537: Mid-Rise New Construction Proposed Raw Costs (Central High Recovery)

Equipment Cost	Quantity	Linear Ft	Unit Material Cost	Labor Hours	Material Cost	Labor Cost	Total Cost
Main Service	1	0	\$60,000.0	40	\$60,000	\$3,800	\$63,800
Unit Panels 100A	0	0	\$700.0	5	\$-	\$-	\$-
Unit Panels 125A	48	0	\$950.0	5	\$45,600	\$22,800	\$68,400
Unit Panels 150A	40	0	\$950.0	5	\$38,000	\$19,000	\$57,000
Unit Panels 175A	0	0	\$950.0	5	\$-	\$-	\$-
Conduit for 100A - 150A Unit Panel -1 1/4"	88	75	\$4.2	0.178	\$27,390	\$111,606	\$138,996
Conduit for 175A Unit Panel -1 1/2"	0	75	\$5.0	0.178	\$-	\$-	\$-
Feeder for 100A Unit Panel - #2 AWG	0	75	\$12.0	0.096	\$-	\$-	\$-
Feeder for 125A Unit Panel - #1 AWG	48	75	\$12.4	0.146	\$44,640	\$49,932	\$94,572
Feeder for 150A Unit Panel - #1/O	40	75	\$14.4	0.18	\$43,200	\$51,300	\$94,500
Feeder for 175A Unit Panel - #2/O	0	75	\$23.0	0.205	\$-	\$-	\$-
50A/2P Breaker for Electric Range	88	0	\$20.5	1	\$1,804	\$8,360	\$10,164
30A/2P Breaker for Electric Dryer	88	0	\$18.5	1	\$1,628	\$8,360	\$9,988
Panel for Elec Water Heater - 200A	1	0	\$950.0	5	\$950	\$475	\$1,425
Conduit for Elec WH Panel - 2"	4	60	\$4.2	0.178	\$1,008	\$4,058	\$5,066
Feeder for Elec WH Panel - #3/O	4	60	\$12.0	0.096	\$2,880	\$2,189	\$5,069
Conduit for In Unit Water Heater - 3/4"	0	40	\$1.4	0.145	\$-	\$-	\$-
Feeder for In Unit Water Heater - #12AWG	0	40	\$1.1	0.043	\$-	\$-	\$-
Total	N/A	N/A	N/A	N/A	\$267,100	\$281,880	\$548,980
Sales Tax	N/A	N/A	9.8%	N/A	N/A	\$-	\$26,042
Sub total	N/A	N/A	0.0%	N/A	N/A	\$-	\$575,022
Overhead	N/A	N/A	15.0%	N/A	N/A	\$-	\$86,253
Contingency	N/A	N/A	10.0%	N/A	N/A	\$-	\$57,502
Profit	N/A	N/A	18.0%	N/A	N/A	\$-	\$103,504
Market Factor	N/A	N/A	8.2%	N/A	N/A	\$-	\$47,152
Total Project Cost	N/A	N/A	N/A	N/A	N/A	N/A	\$869,434

Table 538: Mid-Rise Retrofit Raw Costs (Central High Recovery)

Equipment Cost	Quantity	Linear Ft	Unit Material Cost	Labor Hours	Material Cost	Labor Cost	Total Cost
Main Service	0	0	\$48,000.0	32	\$-	\$-	\$-
Main Service Trenching Upgrades	0	150	\$57.0	0.81	\$-	\$-	\$-
Demolition	2	0	\$-	6.5	\$-	\$1,235	\$1,235
Unit Panels 100A	0	0	\$700.0	5	\$-	\$-	\$-
Unit Panels 200A	0	0	\$950.0	5	\$-	\$-	\$-
Conduit for 100A Unit Panel -1 1/4"	0	75	\$4.2	0.178	\$-	\$-	\$-
Feeder for 100A Unit Panel - #2 AWG	0	75	\$12.0	0.096	\$-	\$-	\$-
Conduit for 200A Unit Panel - 2"	0	75	\$7.5	0.32	\$-	\$-	\$-
Feeder for 200A Unit Panel - #3/O	0	75	\$23.0	0.164	\$-	\$-	\$-
50A/2P Breaker for Electric Range	0	0	\$20.5	1	\$-	\$-	\$-
30A/2P Breaker for Electric Dryer	0	0	\$18.5	1	\$-	\$-	\$-
Panel for Elec Water Heater - 100A	1	0	\$700.0	5	\$700	\$475	\$1,175
Conduit for Elec WH Panel - 1 1/4"	4	60	\$4.2	0.195	\$1,008	\$4,446	\$5,454
Feeder for Elec WH Panel - #2 AWG	4	60	\$12.0	0.105	\$2,880	\$2,394	\$5,274
Conduit for In Unit Water Heater - 3/4"	0	40	\$1.4	0.16	\$-	\$-	\$-
Feeder for In Unit Water Heater - #12AWG	0	40	\$1.1	0.055	\$-	\$-	\$-
Total	0	0	0	0	\$4,588	\$8,550	\$13,138
Sales Tax	0	0	9.8%	0	0	\$-	\$447
Sub total	N/A	N/A	N/A	N/A	0	\$-	\$13,585
Overhead	N/A	N/A	15.0%	N/A	N/A	\$-	\$2,038
Contingency	N/A	N/A	10.0%	N/A	N/A	\$-	\$1,359
Profit	N/A	N/A	18.0%	N/A	N/A	\$-	\$2,445
Market Factor	N/A	N/A	8.2%	N/A	N/A	\$-	\$1,114
Total Project Cost	N/A	N/A	N/A	N/A	N/A	N/A	\$20,541

Single Line Diagrams:

Note: Both “In-Unit” and “Central” gas system SLD’s are synonymous.

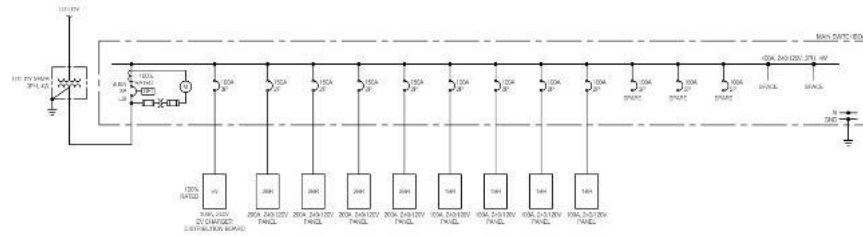

1 LOW RISE GARDEN STYLE BASE GAS IN UNIT - SINGLE LINE DIAGRAM
NO SCALE

Figure 51: Low-rise garden style base case electrical SLD.

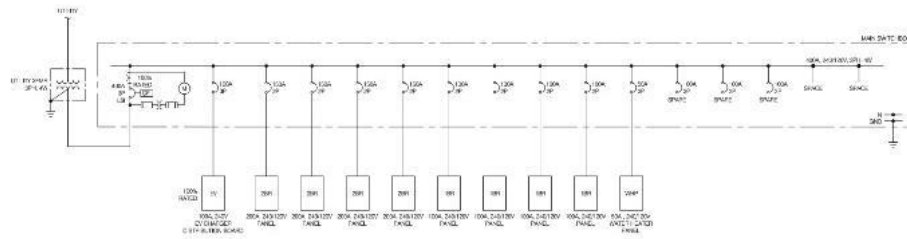

1 LOW RISE GARDEN STYLE CENTRAL - SINGLE LINE DIAGRAM
NO SCALE

Figure 52: Low rise garden style central HPWH electrical SLD.

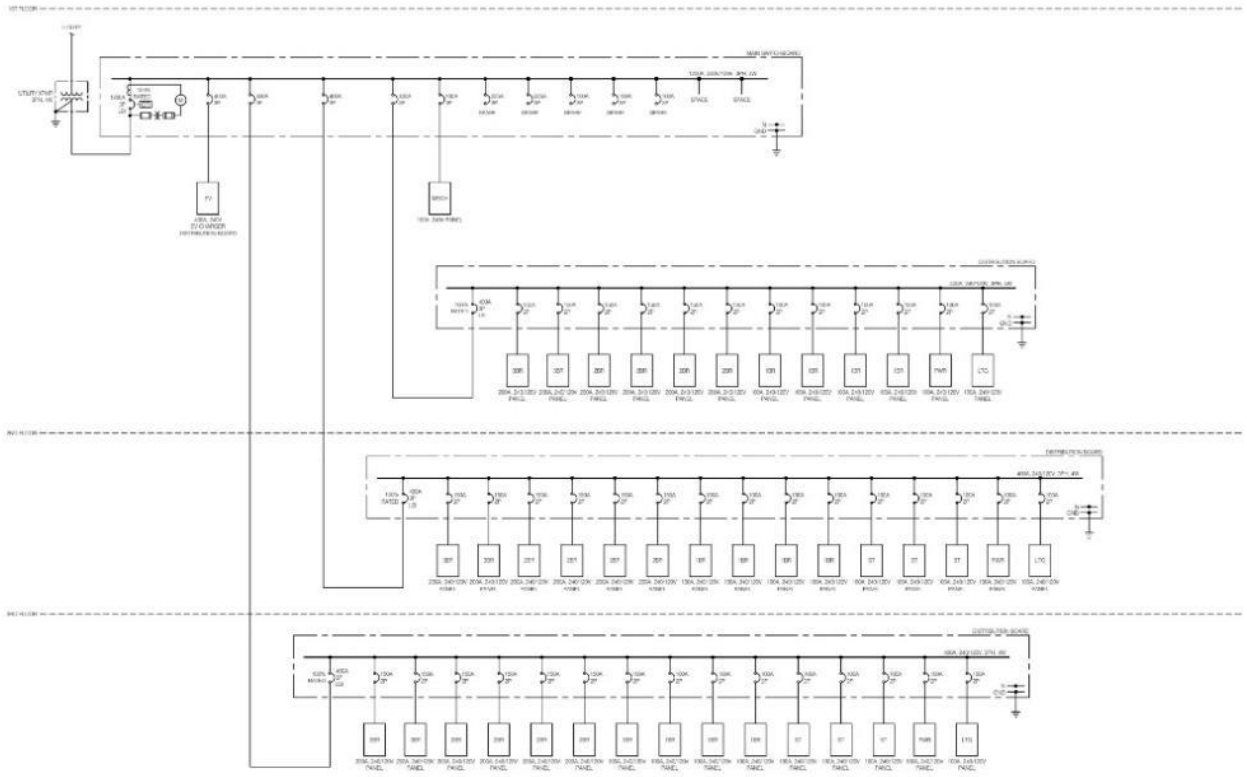

1 LOW RISE LOADED CORRIDOR BASE GAS IN UNIT - SINGLE LINE DIAGRAM
NO SCALE

Figure 53: Low rise loaded corridor base case electrical SLD.

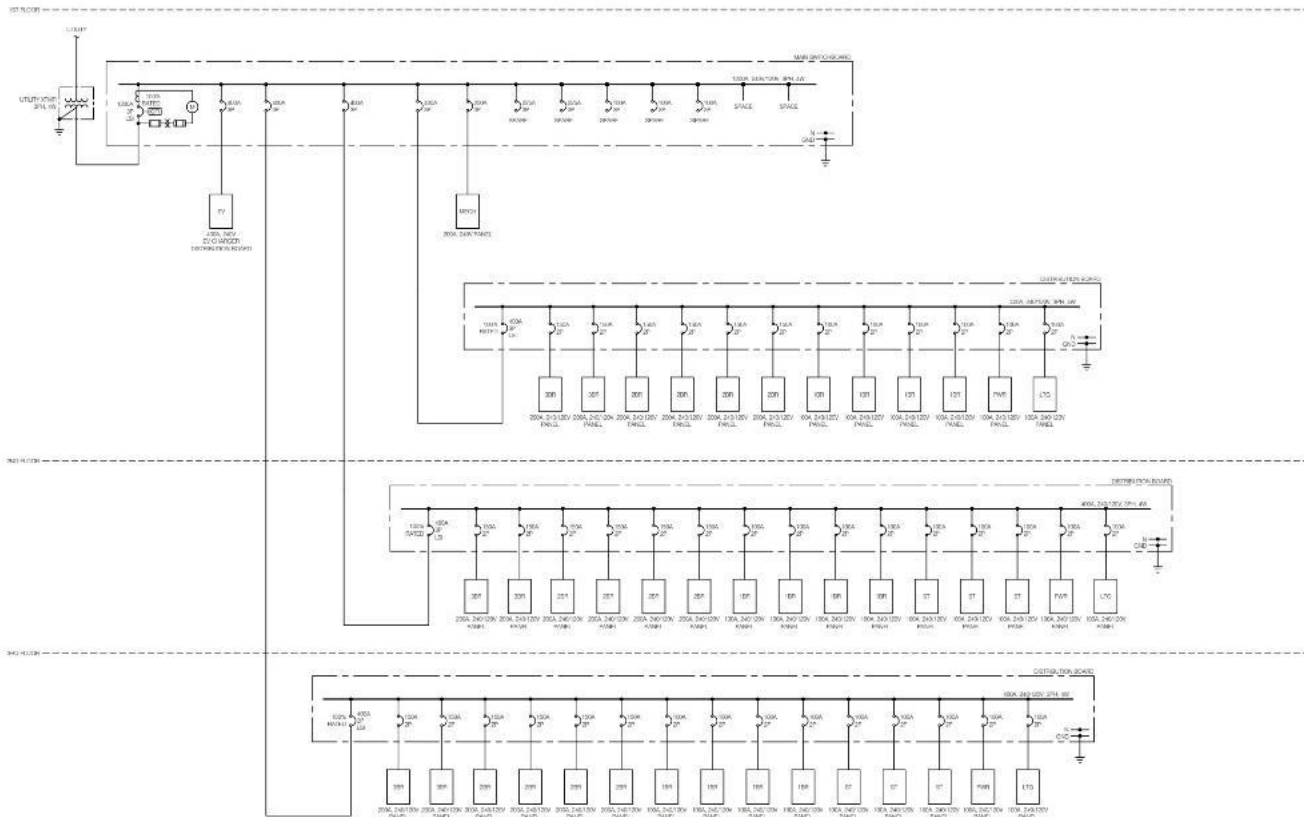

1 LOW RISE LOADED CORRIDOR CENTRAL HIGH RECOVERY - SINGLE LINE DIAGRAM
NO SCALE

Figure 54: Low-rise loaded corridor central high-recovery HPWH electrical SLD.

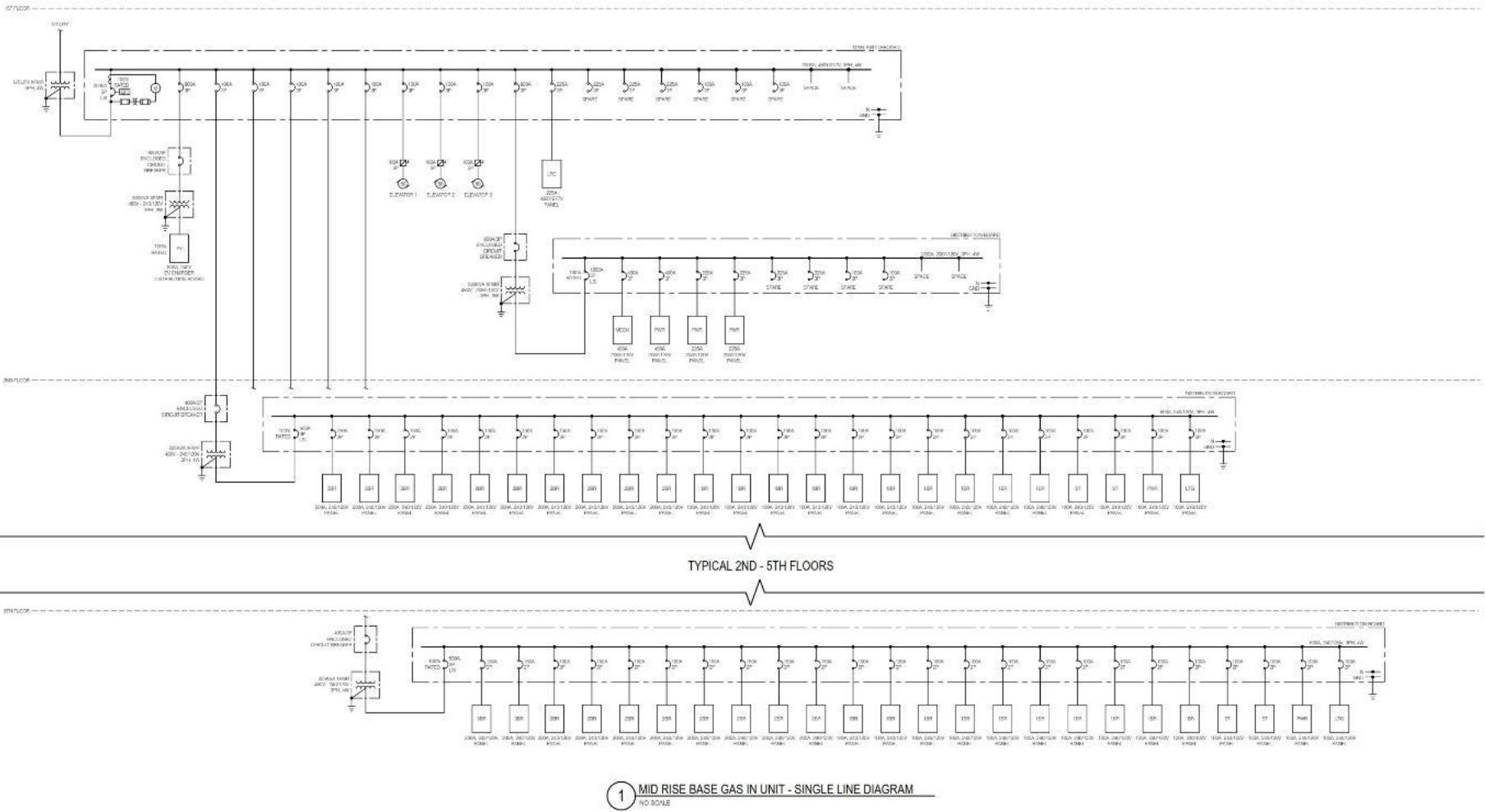
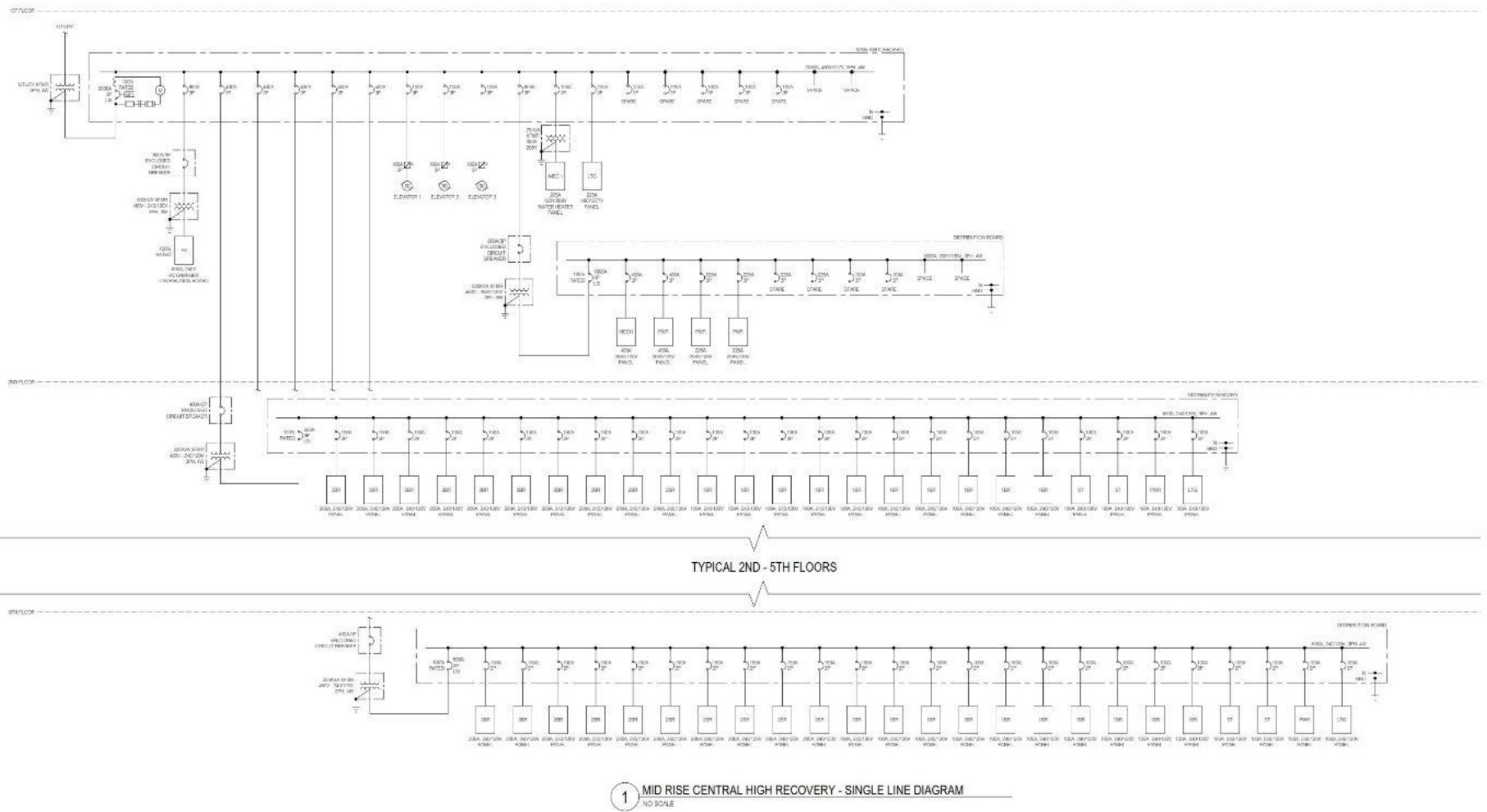

Figure 55: Mid-rise mixed use base case electrical SLD.



P2S ENG

Long Beach // Irvine // Los Angeles
San Diego // San Jose // Seattle

p2sinc.com

TRC Multifamily Electrification Study

Mid Rise Central High Recovery -
Single Line Diagram

SUBMITTAL	DATE	DESIGNED BY	SCALE
Client Review	April 27, 2023	N/A211	1:100

Figure 56: Mid-rise mixed use central high-recovery HPWH electrical SLD.

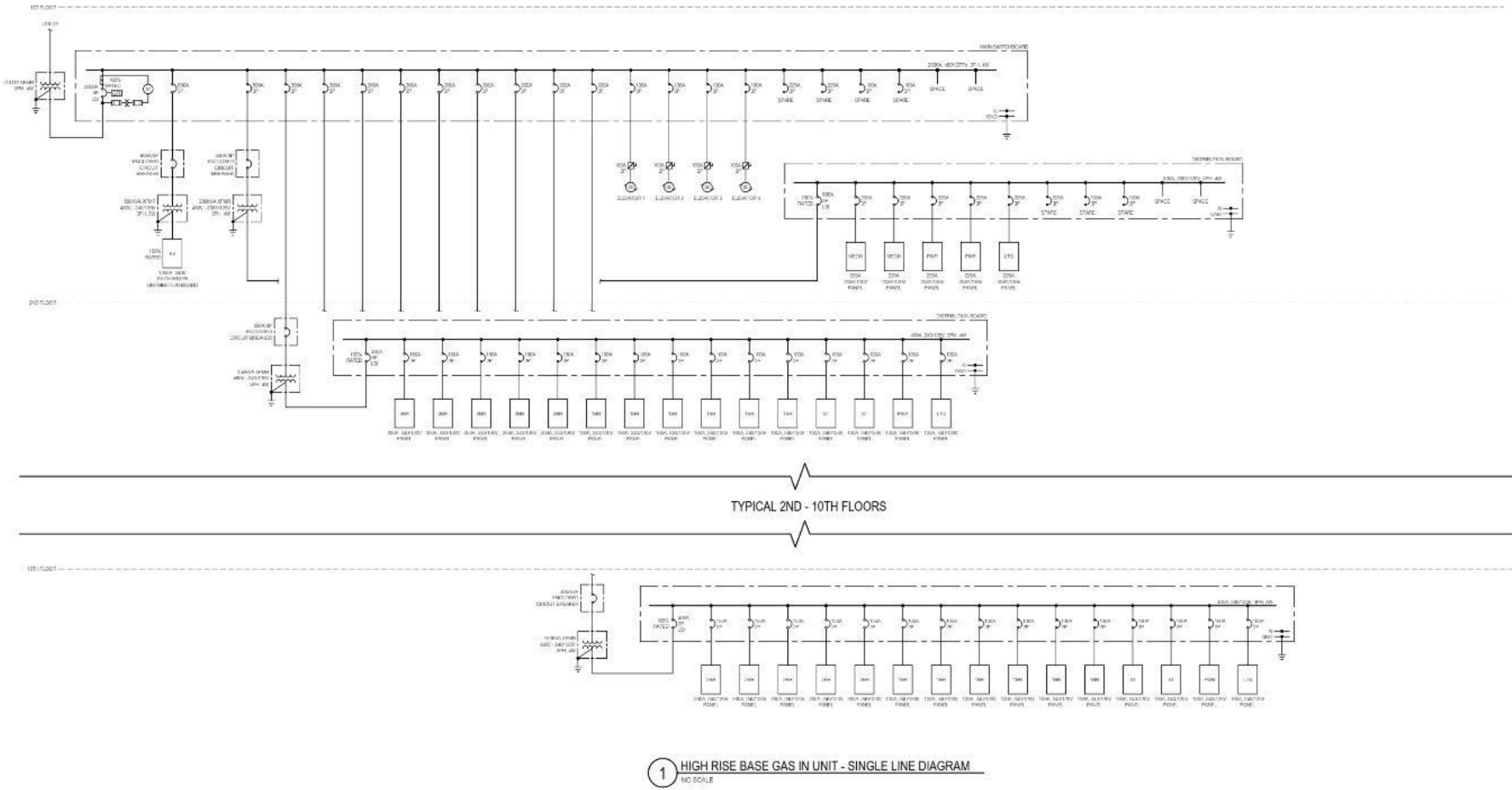

Figure 57: High-rise mixed use base case electrical SLD.

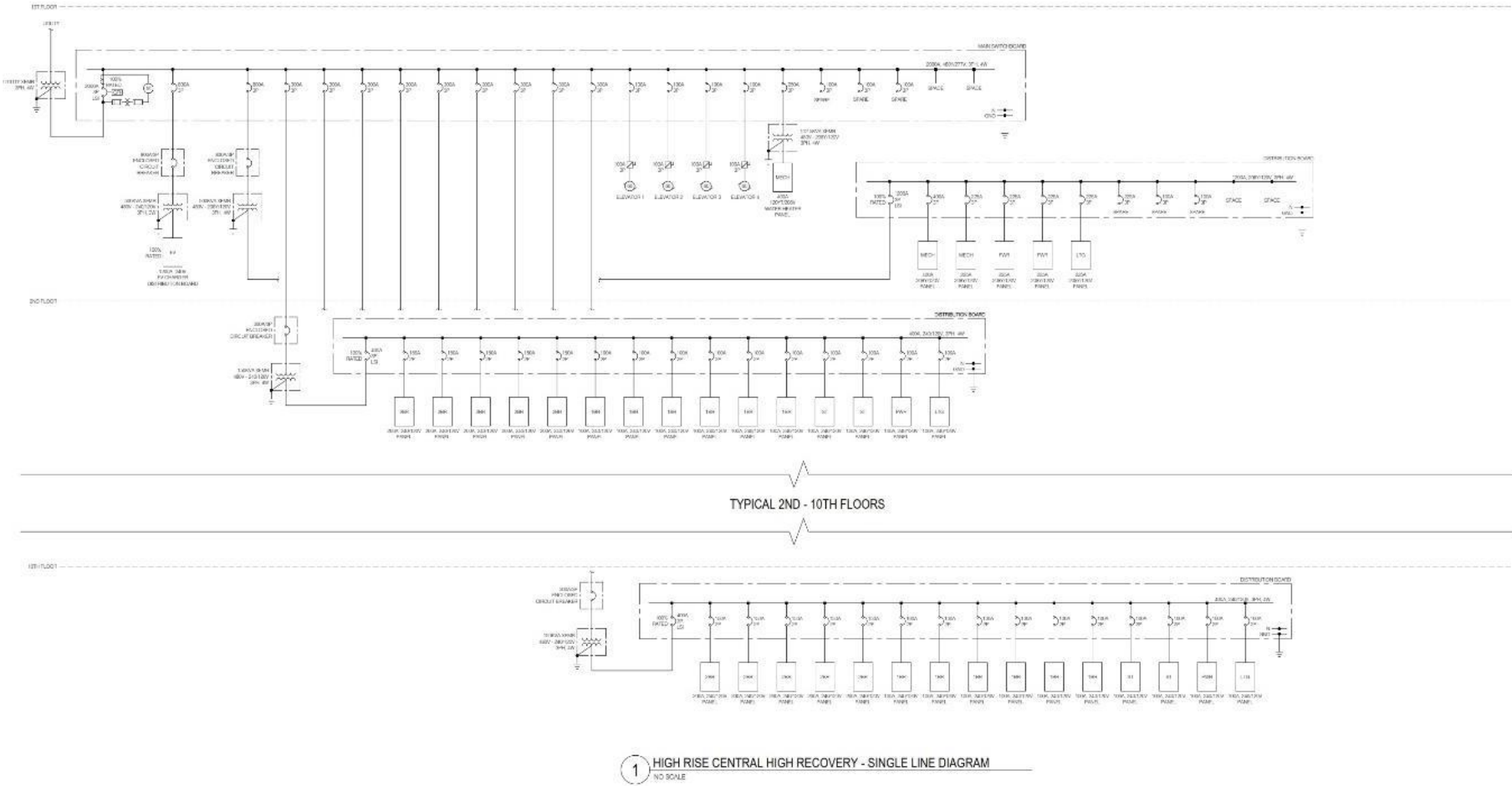

Figure 58: High-rise mixed use central high-recovery HPWH electrical SLD.

Individual Electric Ready

The water heating specifications provided to the electrical engineering and design firm for electrical load calculations, cost estimates, and single line diagrams is shown in Table 539.

Table 539: Individual Dwelling Unit Water Heating System Specifications

# of Units	System	Manufacturer	Model	Volume (gal)	Vent Size	Voltage	MCA (A)
Studio & 1-Unit	Gas	AO Smith	ATI-540HX3-N	Tankless	3"	110V/1Ph	5
		Amtrol	Therm-X-Trol ST-5	2	n/a	n/a	n/a
	HPWH	AO Smith	HPTU-66N	66	8"	220V/1Ph	30
		Amtrol	Therm-X-Trol ST-5	2	n/a	n/a	n/a
2 & 3-Unit	Gas	AO Smith	ATI-540HX3-N	Tankless	3"	110V/1Ph	5
		Amtrol	Therm-X-Trol ST-5	2	n/a	n/a	n/a
	HPWH	AO Smith	HPTU-80N	80	8"	220V/1Ph	30
		Amtrol	Therm-X-Trol ST-5	2	n/a	n/a	n/a

From these specifications, the Statewide CASE Team determined the water heating closet size and ventilation needs for both the gas tankless system and the proposed case heat pump water heater as seen in Table 540. Table 541 contains the raw cost data that was collected by leveraging RSMeans data for the closet augmentation while the door ventilation costs came from costs collected for the proposed HPWH Ventilation measure.

Table 540: DHW Closet Requirements

Gas DHW Ventilation Required	No
Gas DHW Closet Dimensions	39'X23'X96'
HP DHW Ventilation Required	Yes
HP DHW Closet Dimensions	39'X39'X96'

Table 541: DHW Closet Augmentation and Ventilation Raw Cost Data

Work Category	Construction Item	Labor	Materials	Category Total
New Construction (Gas, Base Case)	Partitions 2" X 4" studs, 8' high, studs 16" OC	\$68.66	\$69.74	\$464.00
	Door buck, studs, header, access, 8' high, 2" X 4" wall, 4' wide	\$38.56	\$12.24	
	Gypsum Sheathing	\$36.44	\$45.16	
	2" X 4" wall, 3' wide (Framing Only)	\$144.29	\$48.91	
	Labor/Material Totals	\$287.95	\$176.05	
New Construction (HPWH, Proposed Case)	Partitions 2" X 4" studs, 8' high, studs 16" OC	\$77.24	\$78.46	\$658.80
	Door buck, studs, header, access, 8' high, 2" X 4" wall, 4' wide	\$38.56	\$12.24	
	Gypsum Sheathing	\$36.44	\$45.16	
	2" X 4" wall, 3' wide (Framing Only)	\$144.29	\$48.91	
	HPWH Door Ventilation Grill	\$97.50	\$80.00	
	Labor/Material Totals	\$394.03	\$264.77	
Demolition	Drywall for recycling	\$26.07	\$0.00	\$83.66
	Deconstruction of wood components Wall Framing, interior	\$5.64	\$0.00	
	Wall framing, including studs, plates and blocking, 2" X 4"	\$39.10	\$0.00	
	Selective Demolition Door buck, studs, header & access, 8' high 2" X 4" wall, 3' wide	\$12.85	\$0.00	
	Labor/Material Totals	\$83.66	\$0.00	
Retrofit Case	DEMOLITION	\$83.66	\$0.00	\$742.46
	NEW CONSTRUCTION (HPWH)	\$394.03	\$264.77	
	Labor/Material Totals	\$477.68	\$264.77	

Appendix N: Individual HPWH Ventilation – Nonresidential Analysis Memo

The proposed measure for individual integrated HPWH ventilation in section 8 of this report adds requirements to Title 24 section 110.3(c). Title 24 requirements in section 110.3(c) are mandatory for all occupancies, which includes single family dwellings and nonresidential buildings. Section 8 of this report provides an analysis of the impacts of this measure for single family and multifamily dwellings, but not for nonresidential buildings.

This appendix presents the energy savings and cost-effectiveness for two nonresidential prototypes (Table 542) to demonstrate cost-effectiveness in nonresidential buildings, using the same methodology described in section 8.3 and 8.4.

Table 542: Prototype Buildings Used for Energy, Demand, Cost, and Environmental Impacts Analysis

Prototype Name	Number of Stories	Floor Area (Square Feet)	Description
OfficeSmall	1	5,502	1 story, 5 zone office building with pitched roof and unconditioned attic. WWR- 0.24
RestaurantSmall	1	2,501	Fast food restaurant with a small kitchen and dining areas. 14% WWR. Pitched roof with an unconditioned attic.

These prototypes were selected in consultation with the CEC and subject matter experts as reasonable applications of consumer-sized integrated HPWH technology where cost-effectiveness may be difficult to achieve due to low-usage patterns (OfficeSmall) and high thermal resource availability resulting in low electric resistance use (RestaurantSmall).

The OfficeSmall prototype uses a 30-gallon electric storage water heater by default while the RestaurantSmall prototype uses a 30-gallon gas storage water heater by default. As explained in section 8.3, both the Standard Design and Proposed Design in this measure use HPWHs and the only difference between them is that the Standard Design represents a HPWH with ventilation typical of natural gas storage water heaters, while the Proposed Design represents a HPWH with adequate ventilation according to the proposed code. Therefore, both prototypes were modified to replace the default 30-gallon storage water heaters with the same 50-gallon HPWH used in the residential prototypes presented in section 8.

CBECC assumes perfect ventilation for integrated consumer-sized HPWHs and this cannot be adjusted. Therefore, the Statewide CASE Team used a temperature bin model developed from laboratory test results to adjust the hourly energy use data from CBECC to the ventilation levels in the Standard Design and Proposed Design. Using this method, discussed in detail in section 8.3, the Statewide CASE Team simulated the energy impacts in every climate zone and applied the climate-zone specific LSC hourly factors when calculating energy and energy cost impacts.

Per-Unit Energy Impacts Results

Energy savings and peak demand reductions per unit are presented in Table 543 through Table 546. These savings are the same for both new construction/additions and alterations. The per-unit energy savings figures do not account for naturally occurring market adoption or compliance rates.

Nonresidential results are represented in per square footage instead of per building unit. It should be noted that statewide impacts were not considered in this analysis, therefore results presented in per square foot are of a single building for each building prototype. The square footage of each prototype is given in Table 542.

Table 543: Annual Peak Demand Reduction (W) Per Sq. Ft. by Climate Zone (CZ)

Climate Zone	OfficeSmall	RestaurantSmall
1	0.011	0.159
2	0.011	0.150
3	0.011	0.149
4	0.011	0.147
5	0.014	0.151
6	0.009	0.136
7	0.010	0.135
8	0.010	0.135
9	0.010	0.135
10	0.010	0.136
11	0.011	0.144
12	0.011	0.146
13	0.011	0.141
14	0.011	0.145
15	0.009	0.121
16	0.012	0.160

Table 544: Annual Natural Gas Savings (kBtu) Per Sq. Ft. by Climate Zone (CZ)

Climate Zone	OfficeSmall	RestaurantSmall
1	-	-
2	-	-
3	-	-
4	-	-
5	-	-
6	-	-
7	-	-
8	-	-
9	-	-
10	-	-
11	-	-
12	-	-
13	-	-
14	-	-
15	-	-
16	-	-

Table 545: Annual Source Energy Savings (kBtu) Per Sq. Ft. by Climate Zone (CZ)

Climate Zone	OfficeSmall	RestaurantSmall
1	0.19	3.07
2	0.20	2.88
3	0.19	2.87
4	0.19	2.78
5	0.23	2.89
6	0.18	2.64
7	0.18	2.59
8	0.18	2.56
9	0.18	2.59
10	0.18	2.59
11	0.19	2.75
12	0.19	2.78
13	0.19	2.70
14	0.20	2.76
15	0.17	2.27
16	0.21	3.11

Table 546: Annual LSC Savings Cost Savings (2026 PV\$) Per Sq. Ft. by Climate Zone (CZ)

Climate Zone	OfficeSmall	RestaurantSmall
1	0.92	13.15
2	0.86	12.13
3	0.85	12.16
4	0.84	11.57
5	0.90	12.21
6	0.79	10.97
7	0.78	10.99
8	0.78	10.55
9	0.79	10.64
10	0.79	10.65
11	0.83	11.32
12	0.84	11.52
13	0.81	11.12
14	0.84	11.26
15	0.73	9.20
16	0.94	13.04

Per-Unit Energy Cost Savings Results

Per-unit energy cost savings in terms of LSC savings realized over the 30-year period of analysis are presented as 2026 PV\$ in Table 547 and Table 548. These savings are the same for both new construction/additions and alterations.

Nonresidential results are represented per square feet instead of per building unit. It should be noted that statewide impacts were not considered in this analysis, therefore results presented per square feet are of a single building for each building prototype. The square feet of each prototype is given in Table 542.

Table 547: 2026 PV 30-year LSC Savings – Per Sq. Ft. – OfficeSmall

Climate Zone	30-Year LSC Electricity Savings (2026 PV\$)	30-Year LSC Natural Gas Savings (2026 PV\$)	Total 30-Year LSC Savings (2026 PV\$)
1	0.92	-	0.92
2	0.86	-	0.86
3	0.85	-	0.85
4	0.84	-	0.84
5	0.90	-	0.90
6	0.79	-	0.79
7	0.78	-	0.78
8	0.78	-	0.78
9	0.79	-	0.79
10	0.79	-	0.79
11	0.83	-	0.83
12	0.84	-	0.84
13	0.81	-	0.81
14	0.84	-	0.84
15	0.73	-	0.73
16	0.94	-	0.94

Table 548: 2026 PV 30-year LSC Savings – Per Sq. Ft. – RestaurantSmall

Climate Zone	30-Year LSC Electricity Savings (2026 PV\$)	30-Year LSC Natural Gas Savings (2026 PV\$)	Total 30-Year LSC Savings (2026 PV\$)
1	13.15	-	13.15
2	12.13	-	12.13
3	12.16	-	12.16
4	11.57	-	11.57
5	12.21	-	12.21
6	10.97	-	10.97
7	10.99	-	10.99
8	10.55	-	10.55
9	10.64	-	10.64
10	10.65	-	10.65
11	11.32	-	11.32
12	11.52	-	11.52
13	11.12	-	11.12
14	11.26	-	11.26
15	9.20	-	9.20
16	13.04	-	13.04

Cost-Effectiveness Results

Energy cost savings methodology are the same as those described in section 8.4, as are the incremental first costs. Detail on incremental costs, including maintenance and replacement costs, can be found in Appendix L. Results of the per-unit, cost-effectiveness analyses for each prototype are presented in Table 549 and Table 550.

Nonresidential results are represented per square feet instead of per building unit. It should be noted that statewide impacts were not considered in this analysis, therefore results are presented in per square feet and are for a single building for each building prototype. The square footage of each prototype is given in Table 542.

Table 549: 30-Year Cost-Effectiveness Summary Per Square Feet – OfficeSmall

Climate Zone	Benefits LSC Savings + Other PV Savings ^a (2026 PV\$)	Costs Total Incremental PV Costs ^b (2026 PV\$)	B/C Ratio
1	\$0.92	\$0.03	29.84
2	\$0.86	\$0.04	23.09
3	\$0.85	\$0.03	24.57
4	\$0.84	\$0.04	22.38
5	\$0.90	\$0.04	24.07
6	\$0.79	\$0.03	25.35
7	\$0.78	\$0.03	24.87
8	\$0.78	\$0.03	25.28
9	\$0.79	\$0.03	25.46
10	\$0.79	\$0.03	25.29
11	\$0.83	\$0.03	26.29
12	\$0.84	\$0.03	25.98
13	\$0.81	\$0.03	25.34
14	\$0.84	\$0.03	27.58
15	\$0.73	\$0.03	24.02
16	\$0.94	\$0.03	30.11

Table 550: 30-Year Cost-Effectiveness Summary Per Square Feet – RestaurantSmall

Climate Zone	Benefits LSC Savings + Other PV Savings ^a (2026 PV\$)	Costs Total Incremental PV Costs ^b (2026 PV\$)	B/C Ratio
1	\$13.15	\$0.07	194.36
2	\$12.13	\$0.08	147.92
3	\$12.16	\$0.08	159.34
4	\$11.57	\$0.08	140.76
5	\$12.21	\$0.08	149.09
6	\$10.97	\$0.07	159.38
7	\$10.99	\$0.07	158.37
8	\$10.55	\$0.07	154.68
9	\$10.64	\$0.07	156.80
10	\$10.65	\$0.07	155.36
11	\$11.32	\$0.07	163.34
12	\$11.52	\$0.07	162.38
13	\$11.12	\$0.07	157.48
14	\$11.26	\$0.07	167.40
15	\$9.20	\$0.07	136.78
16	\$13.04	\$0.07	189.53

Results Discussion

Total 30 Year LSC Savings averages \$0.83/square foot for the Office Small prototype and \$11.40/square foot for the RestaurantSmall prototype, or \$4,567/building and \$28,511/building respectively. The substantial savings for RestaurantSmall are due to the high loads and substantial thermal resource available in the kitchen zone.

In the base case (inadequate ventilation) there is substantial resistance heat use due to the high load and lack of ventilation necessary for compressor operation of any significance. In the proposed case, the HPWH is able to take full advantage of the significant thermal resource in the kitchen zone, practically eliminating resistance heat use. This effect can also be seen in the high peak demand reduction shown in Table 548.

The benefit-to-cost ratio (BCR) averages 25.6 for the OfficeSmall prototype and 159.6 for the RestaurantSmall prototype, over the entire 30-year analysis period. For reference, BCRs from the residential analysis ranged from 16.2 to 49.5, depending on the prototype and climate zone. While the OfficeSmall BCR falls within the same range as the residential analysis, the RestaurantSmall BCR is much larger, again due to the large thermal resource available in the kitchen zone, which the HPWH can only make effective use of when provided adequate ventilation.

These results demonstrate that adequate ventilation for integrated HPWHs is essential, and has a high BCR, regardless of the building type and climate zone. Therefore, a mandatory requirement for such ventilation that applies to all building types is justified.

Appendix O: Automatic Balancing Valve Lab Testing

PG&E ATS is conducting a laboratory testing study, funded by PG&E Codes and Standards (C&S) program, to investigate the performance of multifamily hot water recirculation systems. This study aims to provide an in-depth understanding of recirculation system operation by testing a full-scale central recirculation system. More specifically, the study plans to assess the impact of pipe insulation, balancing valves, and recirculation pump control on recirculation system pipe heat loss, hot water delivery temperatures, and return water temperatures. Detailed water flow and pressure measurements would be provided to facilitate the understanding of related performance impact. The Statewide CASE Team coordinated with the testing study team to collect testing data that is needed to support CASE study development.

PG&E C&S program initiated the laboratory testing study on multifamily central recirculation systems shortly after the completion of 2022 Title 24 advocacy. The study team developed a full-scale central recirculation system based on the recirculation system designed by the Statewide 2022 Title 24 CASE Study team for the loaded corridor prototype multifamily building. Figure 59 shows schematics of the test recirculation system. Table 551 provides a comparison between the recirculation system designed for the loaded corridor prototype multifamily building and the test recirculation system. The test recirculation system is only slightly smaller in length and height and, therefore, provides a very good representation of the recirculation system in the loaded corridor prototype multifamily building. Pipe sizes in the test recirculation system are the same as those in recirculation system for the loaded corridor prototype.

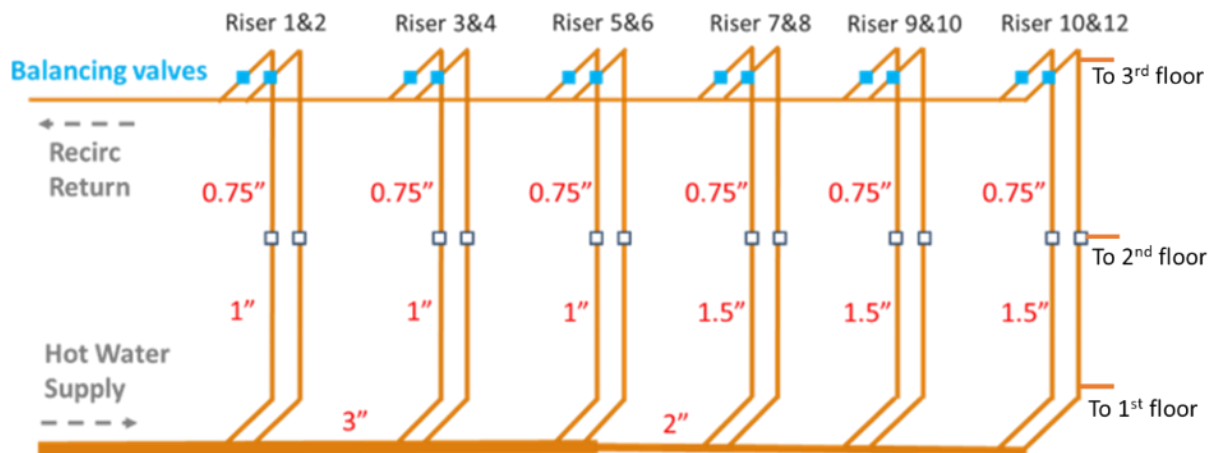

Figure 59: Schematics of recirculation distribution system for testing.

Table 551: Characteristics of Recirculation Distribution Systems

Characteristic	Recirculation system in loaded corridor prototype building	Test recirculation system
Number of risers	13	12
Number of stories	3	3
Number of dwelling units	36	36
Total length	150 feet	123 feet
Total height	18 feet	16 feet

The test recirculation system was “folded”, as shown in Figure 60, so that it could fit into a testing chamber of reasonable size. In this folded setup, supply and return pipes from riser #1 to riser #4 and from riser #9 to riser #12 are straight. Supply and return pipes from riser #4 to riser #9 include pipe sections connected with elbows. The folded setup increases pressure loss between riser #4 to riser #9 and, therefore, the effective pipe length between these risers. This is equivalent to having a recirculation system for a building with a longer length. Branch pipes were installed on riser #1, #2, #3, and #4, which are close to the water heaters, and riser #9, #10, #11, and #12, which are away from the water heaters. With these branches, the full range of hot water draw variation can be simulated.

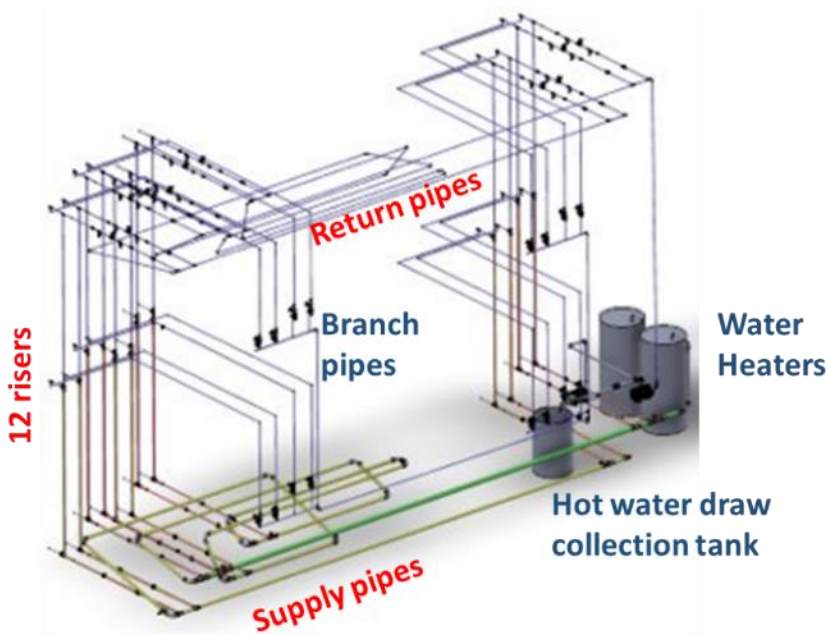

Figure 60: Folded design of test recirculation system.

The test recirculation system is equipped with temperature, flow, and pressure sensors to measure the following parameters to assess system performance:

- Water flow rate for system hot water supply, recirculation return, and each riser
- Temperature at the beginning of hot water supply, the beginning of each riser, the beginning of branch pipes, the entrance of balancing valves, the exit of balancing valves, and the end of recirculation return
- Pressure at the beginning of hot water supply, the beginning of each riser, the entrance of balancing valves, the exit of balancing valves, and the end of recirculation return

The lab study team adjusted their lab testing schedule to support the CASE proposal and assessed the performance of manual balancing valves balanced under ideal lab conditions with flow rate based on standard design practice, and TBVs set to 120°F. Because the Statewide CASE Team requested changes to the lab testing schedule, the lab was not able to test the balancing valves with a variable speed pump. Considering this lab testing gap, the Statewide CASE Team and the lab coordinated a test method that could still be used to prove steady state performance of the thermal balancing valves which involved incrementally adjusting the recirculation pump flow rate from 1 GPM to 6 GPM and observing the performance of the manual and thermal balancing valves at each flow rate with no fixture draws. Based on this modified test procedure, the Statewide CASE Team was able to validate our understanding of thermal balancing valve performance under no draw conditions which are assumed to occur 80 percent of the time. Another limitation of the testing is that the heat loss rate was lower than observed in typical real-world projects, at approximately 40 watts per dwelling unit. This limitation means that recirculation flow rates in the lab testing could be slightly lower than anticipated in real world projects. This limitation doesn't affect the energy savings estimate since the energy modeling is based on a calculation with code compliant pipe insulation, but it could lead to minor disagreement between lab testing data and calculated data.

Figure 61 shows the performance of all six thermal balancing valve recirculation system flow rates as compared to manual balancing valve performance at the standard design flow rate of 6 GPM (0.5 GPM per riser). Riser 9 appears to have a sensor issue and our interpretations of the data ignore Riser 9 since it appears to be an outlier. For the manual balancing valve, a reasonable balance was achieved in the lab and all risers are between 122°F and 124°F with a supply of 125°F. The return temperature at the circulation pump is 122.5°F. The results show that, although a reasonable balance was achieved under ideal lab testing conditions, the design flow rate of 6 GPM (0.5 GPM per riser) is higher than necessary to achieve a return temperature of 120°F at the balancing valve.

The results also illustrate how the minimum thermal balancing valve closed position and valve turn down ratio of the valves tested results in less-than-ideal energy savings; Specifically at 2 GPM, the temperature at Risers R1 through R6 are higher than 120°F,

whereas Risers R10 through R12 are lower than 120°F. At flow rates above 2 GPM, the first risers operate above the set point of 120°F, but this is due in part to the pump operating at a constant flow rate. Because the 2 GPM test has a return temperature at the pump well below 120°F the elevated temperatures at the first risers, at this flow rate, indicate a performance limitation of the TBV themselves. This is qualitatively consistent with the modeling work the Statewide CASE Team performed.

The thermal balancing valve performance is clearly dependent on the pump flow rate; when the pump flow rate is set to 6 PGM the performance of the thermal balancing valves is the performance of the manual balancing valves. When the pump flow rate is set to 1 GPM, the thermal balancing valve balance is poor. The results prove that thermal balancing valves are dependent on proper pump setup and operation. The results also show that a flow rate between 3 GPM and 4 GPM is ideal for achieving the target temperature of 120°F at each riser for this distribution system layout, and Figure 62 shows the same results for only the thermal balancing valves at 3 GPM and 4 GPM and the manual balancing valves at 6 GPM. Figure 62 also compares the TBV performance at 3 GPM and 4 GPM to the manual balancing valve performance at 6 GPM.

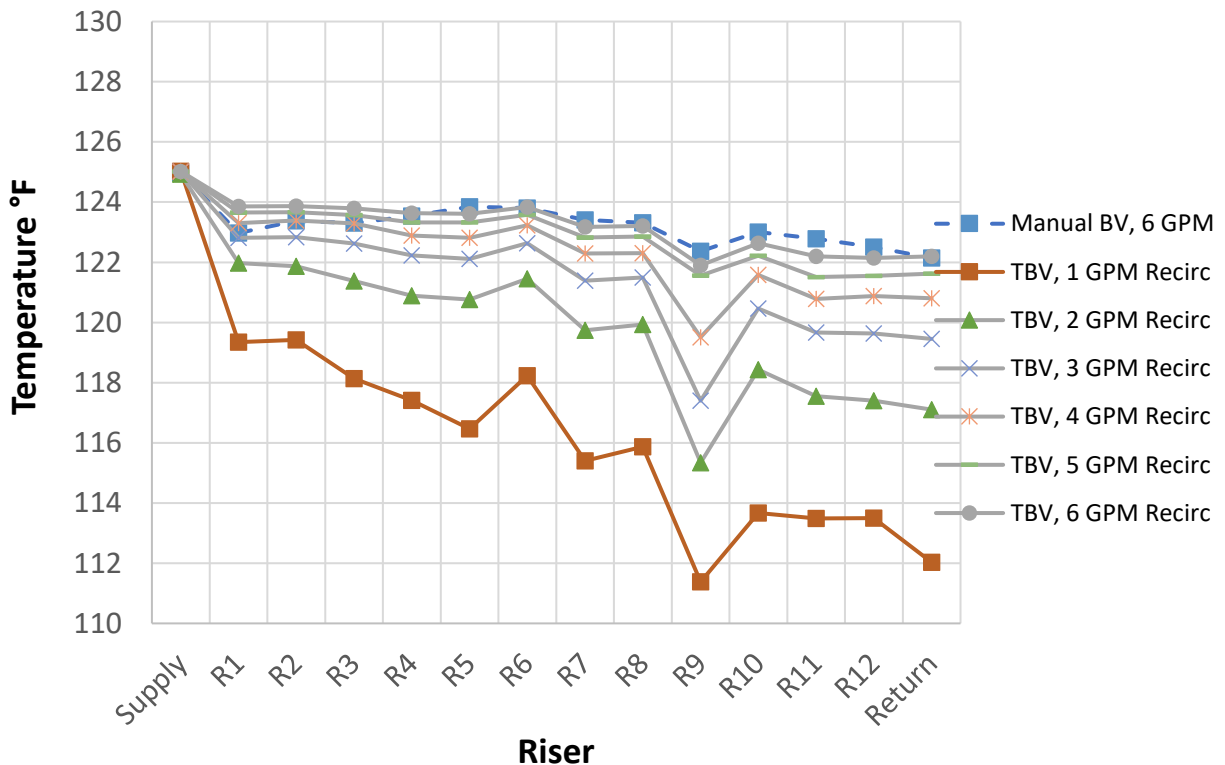

Figure 61: Balancing valve performance at multiple conditions.

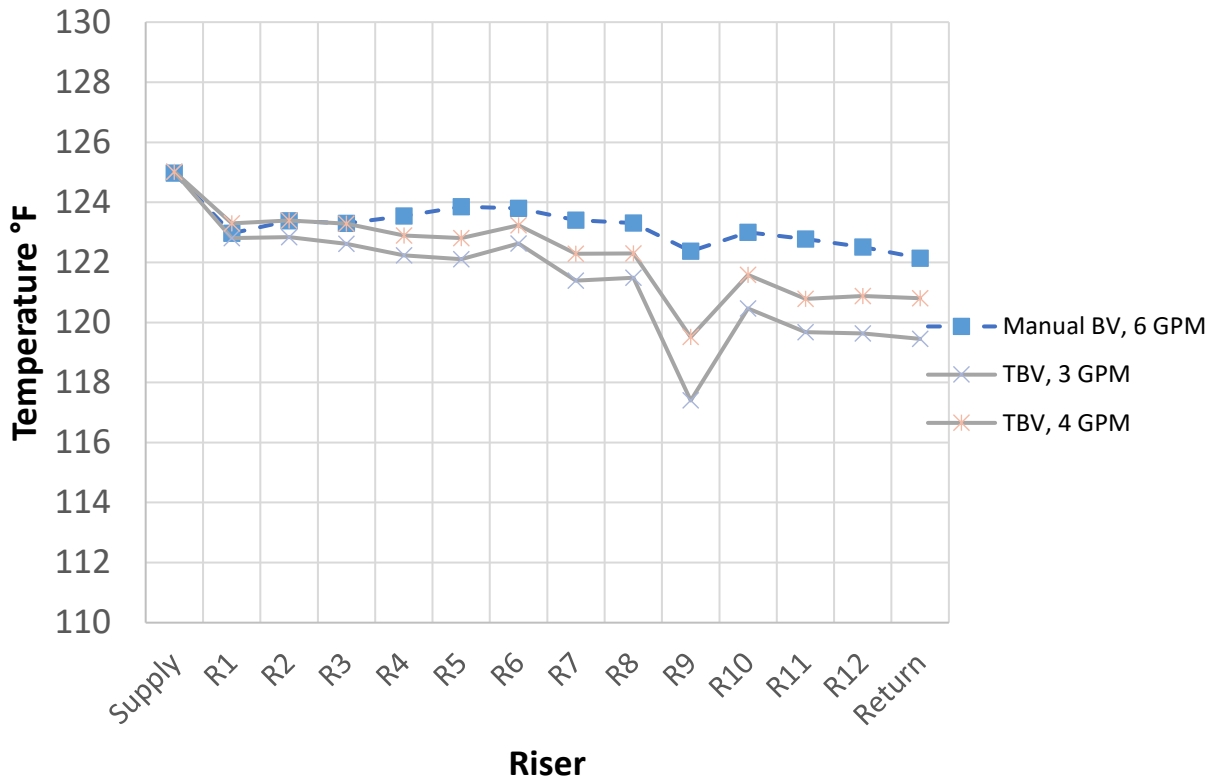

Figure 62: Balancing valve performance at select conditions.

Appendix P: Demand Recirculation Control for Circulation Systems Serving Multiple Dwelling Units

This appendix summarizes the recommendation of the Statewide CASE Team to remove the prescriptive requirement for demand recirculation systems (demand control) for recirculation systems serving multiple dwelling units in multifamily buildings, and stakeholder feedback the Statewide CASE Team received while developing this recommendation.

The Statewide CASE Team received stakeholder feedback after the 2022 CASE cycle that demand controls had been removed from the compliance software due to concerns with technical feasibility in multifamily buildings. During measure development for the 2025 code cycle, the Statewide CASE Team met with CEC staff and CEC energy modeling contractors to understand why demand control was removed from the compliance modeling software. CEC staff and CEC energy modeling contractors confirmed to the Statewide CASE Team that demand controls were removed from the modeling software in 2020 due to concerns with technical feasibility. The Statewide CASE Team also spoke to several domestic hot water subject matter experts and independently identified technical feasibility concerns with the current demand control requirements, including:

1. Multifamily buildings operate 24 hours due to variance in occupant schedules,
2. Allowing the hot water distribution system to cool below roughly 117°F and 120°F can present a health hazard due to possible legionella growth, and
3. Demand control systems are often turned off in existing buildings, in which case there is no real energy savings.

These concerns are like and add to, the concerns that led to the removal of demand control for recirculation systems serving multiple dwelling units from the compliance modeling software. Based on these findings, the Statewide CASE Team recommends removing the requirement from the code language for recirculation systems serving multiple dwelling units in multifamily buildings.

During the February 17th stakeholder meeting (See title24stakeholders.com for meeting notes) the Statewide CASE Team presented findings to the public and asked for feedback on our recommendation. Nine stakeholders agreed, via poll, with the technical feasibility concerns identified. The poll results include the following results for recirculation systems serving multiple dwelling units in multifamily buildings:

1. Four stakeholders indicated that demand control systems are often turned off,
2. Three stakeholders indicated that, for multifamily applications, providing adequate hot water 24 hours per day is a technical feasibility concern with demand control requirements, and

3. Two stakeholders indicated that increased risk of legionella growth is a concern.
4. After the poll one stakeholder did give the Statewide CASE Team feedback that some form of circulation pump control be implemented.

Based on the stakeholder feedback received and the fact that the compliance modeling software no longer accounts for demand controls, the Statewide CASE Team recommends that the prescriptive requirement for demand control for recirculation systems serving multiple dwelling units in multifamily buildings be removed.

Appendix Q: Master Mixing Valve Lab Testing

PG&E ATS conducted a laboratory testing study, funded by PG&E Codes and Standards (C&S) program, to investigate the performance of centralized heat pump based multifamily hot water systems with continuous recirculation. The 24-hour application system testing components aimed to provide an in-depth understanding of water heater and pipe recirculation system operation by testing a full-scale heating plant and mimicking a central recirculation system serving 4, 8, and 44 dwelling units and associated low-, medium-, and high-water draw profiles for each building types. The total list of HP configuration types tested that adequately performed is shown in Table 552.

Table 552: HP Heating Plant Lab Test Configurations

HP Configurations	Mimic Distribution Loop with 4 or 8 Dwelling Units	Mimic Distribution Loop with 44 Dwelling Units
Integrated HP with Integrated Electric Resistance Hybrid Heater with Return to Hybrid Heater (120°F Hot Supply Setpoint, 10°F ΔT, 100 Watt/DU Pipe Heat Loss)	✓	-
Single Pass HP with Series Electric Resistance Storage Heater to Maintain TMS (120°F Hot Supply Setpoint, 10°F ΔT, 100 Watt/DU Pipe Heat Loss)	-	✓
Single Pass CO2 HP with Series Electric Resistance Storage Heater to Maintain TMS (120°F Hot Supply Setpoint, 10°F ΔT, 100 Watt/DU Pipe Heat Loss)	✓	-
Single Pass HP/Storage Tank with Parallel Multi Pass HP/Tank to Maintain TMS (120°F Hot Supply Setpoint, 10°F ΔT, 100 Watt/DU Pipe Heat Loss)	-	✓
Single Pass HP Return to Upstream Primary Storage Tank (120°F Hot Supply Setpoint, 10°F ΔT, 100 Watt/DU Pipe Heat Loss)	✓	✓
Single Pass HP Return to Upstream Primary Storage Tank (120°F Recirc Return Setpoint, 2-5°F ΔT, 50 Watt/DU Pipe Heat Loss)	-	✓

More specifically, the application testing assessed the impact of various HP technologies and settings such as:

- Integrated or split HP system configurations
- By HP refrigerant type
- Single or multi-pass HP operation
- Various heat pump ON and OFF setpoint temperatures and sensor locations in primary tank(s)

- Based on various return to primary storage tank recirculation return and HP supply and return piping configurations
- Primary tanks in series or in parallel configuration
- With various temperature maintenance system (TMS) configurations to reheat water in the continuous recirculation loop with either a swing or parallel temperature maintenance tank setup.
- TMS ON and OFF tank setpoint temperatures
- TMS tank heating element location with electric resistance heater

Lab testing also adjusted various parameters of the distribution system including:

- Recirculation flow rates
- Recirculation supply and recirculation return temperature
- Pipe heat loss rates
- Temperature drop from the MMV outlet to recirculation return location.

One aspect of the heating plant configuration was to test the system with and without a MMV installed on the hot water supply header at the start of the recirculation loop with continuous recirculation. Most of the testing was conducted with a digital MMV, with a minority of the application testing conducted with single or high-low mechanical MMV and no MMV test scenario. The various MMV test configurations are:

- No MMV
- Digital MMV (native control)
- Digital MMV (test program control)
- Single High Mechanical MMV
- High-Low Double Valve Mechanical MMV with Pressure Regulator

The Statewide CASE Team coordinated with the Code Readiness lab testing project team and members of the PG&E codes and standards team to collect test data to support the MMV code measure development. The first round of testing, conducted in Q4 2022, provided valuable insight into the savings potential of using MMV at the heating plant versus using one at each dwelling unit to provide a safe temperature at the end use fixture. The tests showed preliminary hot water system average savings of 10.7 percent or annual savings of 6,000 kWh when normalized for the three heating plant configurations where the digital MMV was compared to no MMV test configuration. There were slightly less savings from the mechanical MMV at 8.5 percent versus no MMV test setup. The Statewide CASE Team later learned that the mechanical MMV was not properly installed and commissioned as a High-Low MMV and more represented the operation of a large single MMV. Additionally, due to a malfunction in the digital MMV related to a temperature sensor that was unresolved in previous commissioning attempts, the lab test software program with an external temperature sensor was used to control the digital MMV. The one downside was the lab test

program was limiting the mixing ratio band of hot and cold water, thus slightly reducing its performance and energy saving potential.

From the Q4 2022 lab testing, a significant performance difference (energy consumed at the water heater) between the mechanical valve and digital valve was not visible in Table 553 to Table 555 and summarized in Table 556 with the set of 100W pipe heat loss per dwelling unit application tests with 10°F temperature drop from MMV outlet to recirculation return temperature. There are two reasons for this lack of differentiation. One reason is the large temperature drop in the loop provided an average mixing ratio (33 percent of recirculation water flow leads to tank and 66 percent leads to cold side of MMV) at the valve that is within the normal operating range of both mechanical and digital MMVs. The second reason is that application testing had to override the standalone controls in the digital MMV with lab testing software and controls that slightly limited the valve's energy saving potential.

The subsequent testing conducted in Q1 2023 with results shown in Table 554 and Table 555 in the last row for the Single Pass HP Return to Upstream Primary Tank heating plant design overcame these limitations. A standalone digital MMV was installed, and the mechanical valve reinstalled with pressure reducing valve and commissioned to work as a single valve (large valve) and in High-Low (small and large valve with pressure reducing valve) configuration. The results from the High-Low valve test are shown in Table 554.

The Statewide CASE Team wanted to deviate from the ideal (from energy efficiency perspective) recirculation system water temperature parameters of 120°F supply and 110°F return to better align with pathogen safety guidelines. The team also wanted to better align with the proposed pipe insulation enhancement guidelines for continuous insulation that aligns closer to testing the distribution loop with a pipe heat loss rate of 50 watts per dwelling unit. In advance of the MMV second round of lab testing in 2023, the Statewide CASE Team interviewed a prominent designer of high efficiency HPWH centralized systems. This designer's practice is to keep the mixed outlet temperatures (125°F) as low as possible to minimize pipe heat losses, but ensure return temperatures (122°F) are as high as possible to meet pathogen safety guidelines while incorporating a safety factor for the accuracy of the digital valve to ensure that return water temperatures do not drop below 120°F. Thus, in this design the recirculation loop utilizes a 3°F temperature drop. The Statewide CASE Team's second round of lab testing was able to test a 2°F temperature drop for a 123°F supply and 121°F return for digital MMV testing in Table 555.

The Statewide CASE Team's hypothesis was that modern design is being dictated by new health, energy efficiency (uniform pipe insulation, appendix M sizing) and plumbing trends or code changes that would make it more difficult for mechanical MVs to control distribution systems that have been optimized for energy efficiency and pathogen

mitigation due to temperature creep and other performance limitations such as a maximum of 80 percent hot water to 20 percent cold water (includes recirculation return water) mix ratio in the majority of mechanical valves.

The results in Table 553 and Table 555 show that energy savings from digital MMV versus no MMV test configuration is dependent on the hot inlet temperature to the MMV from the heating plant. The first two configurations (first two rows) either use an electric resistance heater in series or multi pass HP/Tank combination in parallel to maintain the recirculation loop temperature. The heating plant outlet temperature are lower due to lower setpoint temperatures in the TMS tanks since they only must maintain the temperature in the recirculation loop rather than HP primary storage tank setpoints in a return to primary system configuration, which have the additional responsibility of maintaining hot water heating capacity. The heating plant outlet temperature is also the mixing valve inlet hot water temperature and is lowest in these configurations with recirculation loop reheat tanks in series (126°F) and parallel (130°F), thus the energy savings potential of adding a MMV is reduced for a savings of 6.5 percent and 7.5 percent, respectively. With the recirculation return to primary configurations in the last 3 rows, the mixing valve inlet hot water temperature is higher ranging from 135°F to 140°F, thus the energy savings of adding a MMV to reduce the recirculation loop supply temperature is much higher with 14.3 percent savings with multi-pass HP configuration and 8.5 percent and 18.0 percent with the two single-pass configurations in Table 556. Testing in the laboratory was limited due to time constraints, and all HPWH test configurations with and without mixing valves could not be tested. No more MMV testing is planned currently.

Table 553: Lab Test Results of HPWH System without MMV.

Heating Plant Design	Heating Plant Outlet Temp (kWh)	No MMV Normalized Electricity In (kWh)	No MMV System COP	No MMV Return Temp (°F)	Recirc Loop Pipe Heat Loss Rate (Watts/DU)
Single Pass HP with Series Electric Resistance Heater	126	190.0	1.3	114	110
Single Pass HP with Parallel Multi Pass HP/Tank	130	162.9	1.5	118	118
Multi Pass HP Return to Primary Tank	139	180.8	1.3	126	136
Single Pass HP Return to Upstream Primary Tank	136	158.8	1.54	122	127
Single Pass HP Return to Upstream Primary Tank	138	158.8	1.5	122	127

Table 554: Lab Test Results of HPWH System with Mechanical MMV.

Heating Plant Design	Mech MMV Normalized Electricity In (kWh)	Mech MMV System COP	Mech MMV Outlet Temp (°F)	Mech MMV Return Temp (°F)	Recirc Loop Pipe Heat Loss Rate (Watts/DU)
Single Pass HP with Series Electric Resistance Heater	180.2*	No Data	No Data	No Data	No Data
Single Pass HP with Parallel Multi Pass HP/Tank	153.0*	No Data	No Data	No Data	No Data
Multi Pass HP Return to Primary Tank	161.4*	No Data	No Data	No Data	No Data
Single Pass HP Return to Upstream Primary Tank	145.4	1.63	121	110	105
Single Pass HP Return to Upstream Primary Tank	139.8	1.7	124.6	120**	62

* 2022 Testing: Energy use data or calculated savings percentage is approximated.

** 2023 Testing: Targeted 5°F temperature drop (distribution hot water supply to return) and 120°F return temperature for mechanical MMV.

Table 555: Lab Test Results of HPWH System with Digital MMV.

Heating Plant Design	Digital MMV Normalized Electricity In (kWh)	Digital MMV System COP	Digital MMV Outlet Temp (°F)	Digital MMV Return Temp (°F)	Recirc Loop Pipe Heat Loss Rate (Watts/DU)
Single Pass HP with Series Electric Resistance Heater	178.4	1.4	120.0	110	99
Single Pass HP with Parallel Multi Pass HP/Tank	151.5	1.6	120.0	110	99
Multi Pass HP Return to Primary Tank	158.2	1.5	120.0	110	99
Single Pass HP Return to Upstream Primary Tank	146.3	1.69	120	110	101
Single Pass HP Return to Upstream Primary Tank	134.6	1.8	123.1	121*	48

* 2023 Testing: Targeted 2°F temperature drop (distribution hot water supply to return) and 120°F return temperature at 50 watts/dwelling unit for digital MMV.

Table 556: Summary of MMV Energy Savings with and without MMV.

Heating Plant Design	Savings: No MMV to Mechanical MMV	Savings: No MMV to Digital MMV	Savings: Mechanical MMV to Digital MMV	Annual Savings from Digital MMV from no MMV (kWh)
Single Pass HP with Series Electric Resistance Heater	5.4%*	6.5%	1.0%*	4230
Single Pass HP with Parallel Multi Pass HP/Tank	6.5%*	7.5%	1.0%*	4167
Multi Pass HP Return to Primary Tank	12.0%*	14.3%	2.0%*	8236
Single Pass HP Return to Upstream Primary Tank	9.2%	8.5%	-0.6%	4539
Single Pass HP Return to Upstream Primary Tank	13.5%	18.0%	3.9%	8830

* 2022 Testing: Energy use data or calculated savings percentage is approximated.

Table 557 presents the system energy savings percentage when compared to the mechanical MMV standard design. In most cases, there is additional energy savings when compared to digital MMV. Negative energy savings percentage values for the proposed design with no MMV test means that the configuration used more energy than the standard design.

Table 557: System Energy Savings from Mechanical MMV Standard Design

Heating Plant Design	Savings: No MMV to Mechanical MMV	Savings: Mechanical MMV to Digital MMV
Single Pass HP with Series Electric Resistance Heater	-5.4%	1.0%
Single Pass HP with Parallel Multi Pass HP/Tank	-6.5%	1.0%
Single Pass HP Return to Upstream Primary Tank (10°F ΔT)	-9.2%	-0.6%
Single Pass HP Return to Upstream Primary Tank (2-5°F ΔT)	-13.5%	3.8%
Multi Pass HP Return to Primary Tank	-12.0%	2.0%

Appendix R: Building Level Electric Readiness Cleanup

While developing the central HPWH electric ready proposal and the individual HPWH electric ready cleanup proposal, the Statewide CASE Team worked with an experienced electrical engineering firm to understand how the existing requirements of Title 24, Part 6, Section 160.9 impact the sizing of the building electrical system upstream of each dwelling unit, as described in Appendix M. As part of this process, the Statewide CASE Team realized that although it is standard practice for electrical designers to design the entire building system to meet the electric ready requirements of Section 160.9, the current language does not explicitly require the components upstream of the dwelling unit main panel to be sized appropriately, except in the case of electric clothes dryers in common areas. This Appendix outlines some of the technical ramifications of the gap in the current code requirements and discusses the benefits of improving the language of Section 160.9 by adding the proposed section 160.9(f).

The current requirements for individual HPWH electric ready, heat pump space heater ready, electric cook top ready, and individual electric clothes dryer ready have explicit requirements for the size of the branch circuit serving the appliance, and for reserve physical space in the dwelling unit main panel, but do not explicitly address the electrical capacity of the dwelling unit main panel or sizing of conduit and wire serving the dwelling unit main panel, distribution boards, transformers, or the building main service. As described in Appendix M: Individual DHW and Central DHW Electric Ready Basis of Design and Cost Details, the building level components are large and costly, and can present significant technical and financial barriers if they need to be retrofitted later with significant detrimental effects to the positive impacts of electric readiness.

The addition of Section 160.9 (f) requires that anticipated future electric loads by electric ready measures be taken into consideration from the end use through the building main service. Figure 48 and Figure 49 in Appendix M outline the typical building electrical system components for your reference.

The Statewide CASE Team performed a building level electrical equipment sizing analysis to compare the size of the building electrical components between the dwelling unit main panel and the building main service for cases where all electric ready components were sized appropriately as part of the existing electric ready requirements, and for cases where they were sized only for the existing gas equipment, but not for the electric ready equipment. The results for the Low-Rise Loaded Corridor prototype analysis in Table 558 demonstrate that if the electrical systems upstream of the dwelling unit main panel are not sized appropriately as part of the electric ready design, every dwelling unit would require main service and feeder retrofits. Retrofitting these

components would be technically challenging, disruptive to residents, and have significant unintended costs. Similar impacts are seen for all four building prototypes.

Table 558: Low-Rise Loaded Corridor Building Level Electric Ready Planning Impacts (In-unit HPWH/ In-unit Dryer/ In-unit Range)

Serving	No Building Level Electrification Planning	With Building Level Electrification Planning	Required Upgrades
Studio Units	100A Panel 1 1/4" Conduit, #2AWG Feeder	150A Panel 1 1/4" Conduit, #1/O Feeder	Dwelling unit main panel Feeders serving dwelling unit main panel
1-BR Units	100A Panel 1 1/4" Conduit, #2AWG Feeder	150A Panel 1 1/4" Conduit, #1/O Feeder	Dwelling unit main panel Feeders serving dwelling unit main panel
2-BR Units	100A Panel 1 1/4" Conduit, #2AWG Feeder	150A Panel 1 1/4" Conduit, #1/O Feeder	Dwelling unit main panel Feeders serving dwelling unit main panel
3-BR Units	100A Panel 1 1/4" Conduit, #2AWG Feeder	175A Panel 1 1/2" Conduit, #2/O Feeder	Dwelling unit main panel Conduit serving dwelling unit main panel Feeders serving dwelling unit main panel
Floor Level Distribution	600 Amps	1000 Amps	Floor level distribution boards, No impact to floor level transformers
Building Main Service	817 Amps, (1000A Switchboard)	1236 Amps, (1600A Switchboard)	Switchboard, Main service conduit

The Statewide CASE Team presented its proposal for improvement of Section 160.9 during a public stakeholder meeting that the Statewide CASE Team held on February 17, 2023, along with preliminary qualitative analysis based on conversations with an electrical design engineering firm. The Statewide CASE Team asked in a poll if stakeholders agree with our standard practice description and the technical challenges of retrofitting electrical components upstream of the dwelling unit main panel. We received two responses neither of which disagreed with our description. One comment favored our proposal, and the other comment was a recommendation for other equipment that could be considered for electric readiness. The Statewide CASE Team discussed this issue again briefly in the context of the central HPWH electric ready proposal and the individual HPWH electric ready clean-up proposal during a second public stakeholder meeting held on May 1, 2023. Based on the evidence available to the

Statewide CASE Team, we determined that it is already standard practice to size electrical equipment to meet the anticipated future loads of electric ready measures, but that adding Section 160.9 (f) would ensure that this planning is not skipped, avoiding potential significant negative impacts to the occupants.